

LIGHT UP WHEEL TILT AND TURN SCOOTER INSTRUCTIONS

K: 43419432 | T: 69508196

WARNING! Assembly by an adult.

WARNING! Not suitable for children younger than 3 years old, due to danger of falling.

WARNING! Protective equipment should be worn.

WARNING! Not suitable for children with a body mass of more than 50 kg.

WARNING! Do not use on public roads.

Remove the scooter and all the parts from the box. Set out all the parts and read the assembly instructions prior to use. Keep the packaging until assembly is complete.

General instructions

- This scooter must be assembled by a responsible adult. Prior to use, make sure that the scooter has been assembled properly. Remove all the parts which are not necessary for play before giving the scooter to your child. Due to the skill it requires, the scooter must be used with care in order to avoid falls or collisions likely to injure the user or others.
- To be used with suitable protective equipment, including a helmet, shoes, elbow, wrist and knee protection. Teach the child how to use it safely and responsibly.
- The scooter is not a toy for children under the age of 3 years.

Directions

- a) The scooter can be dangerous and can lead to traffic accident when used on public highways. Do not use on the public roads.
- b) For use on smooth, paved surfaces only.
- c) Avoid bumps and drainage grates that may cause an accident.
- d) The scooter does not include any headlights or lights. It is therefore not suitable for use at night or during periods when visibility is limited.
- e) Always use under adult supervision.
- f) Do not allow more than one child to ride the scooter at the same time.

Before and after use

To prevent pinched fingers, keep your hands on the outside of the handlebar and the

footrest when opening and closing the scooter. Make sure that all locking mechanisms are securely locked:

- Check the height of the steering system, and make sure the nuts are tightened.
- Check all of the connection elements: the brake, the quick release system of the steering column and the wheel axles are adjusted correctly and not damaged.
- Also check the wheels wear.

During use

- Hold both handgrips firmly. Put one foot towards the front of the deck. With the other foot, push off the ground to propell the scooter forward. Both feet can fit on the deck when desired speed has been reached. To stop, step on the brake with the rear foot.
- Braking: a brake is located at the rear, when necessary, press down on it to slow down. Press down gradually in order to prevent skidding or loss of stability. The brake may heat up after multiple uses. Avoid touching it during and after use.
- Shoes are mandatory and we strongly advise you to wear pants and long sleeve shirts to avoid injury if you fall.
- Children should be reminded that the scooter should be used with caution, since it requires skill, so as to avoid falls or collisions causing injury to the user and others.

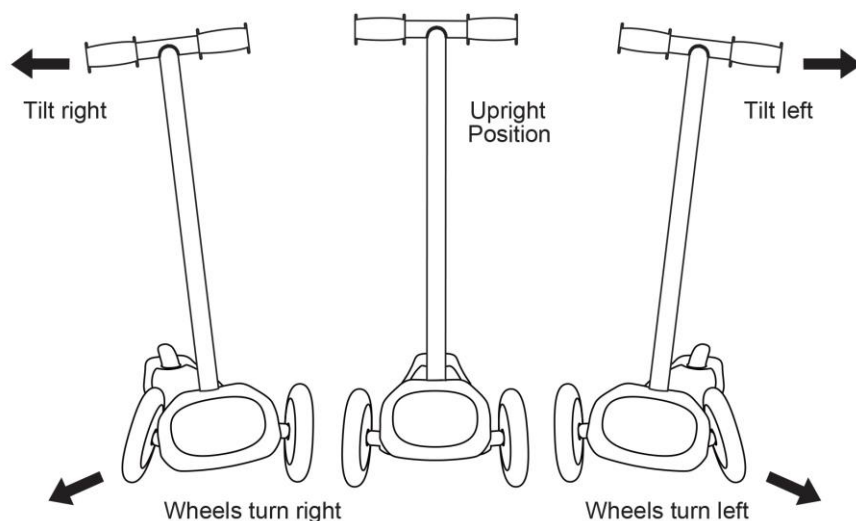

Assembly Instructions:

1. UNFOLD THE SCOOTER

Hold the scooter and pull up the bottom of the handlebar.

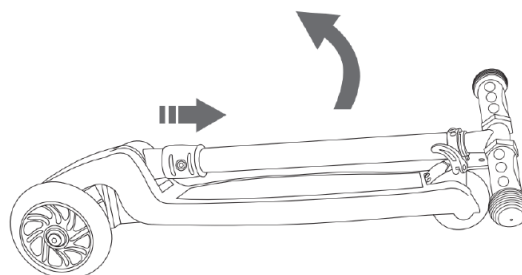

2. ADJUST THE HANDLEBAR

Release the quick lock, adjust the handlebar until the button pop into the fixation hole, then tighten the quick lock.



NOTICE: Always ensure handlebar is locked into place before use.

Care Instructions

A . Wheel bearings: Avoid going through water, oil or sand as this can damage to the wheel bearings.

To look after the wheel bearings, systematically check that the wheels turn properly by turning the scooter upside-down and using your hand to spin the wheels. If the wheels do not spin they must then be removed to check their condition. First unscrew the wheel axle, remove the axle and detach the wheel, then carefully push the two wheel bearings out of their housing. If they are chipped or dented, they should be replaced. If there is no visible damage, they must then be oiled. To do this, remove all traces of grease, mud or dust with a kitchen towel or cloth, and re-oil them with a grease spray or by leaving them to soak overnight in oil [turn them several times in the oil first]. Reassemble the wheel bearings and axles, followed by the wheel, onto the scooter. Repeat process for the other wheel.

B. Wheels: The wheels wear down with time and can be pierced if overly used on rough surfaces. The back wheel on which the brake is applied is particularly affected after several hours of braking. In the interest of safety, they should be checked regularly and changed if necessary.

C. Modifications: The original scooter must by no means be modified except for the maintenance-related changes mentioned in these instructions.

D. Nuts and axles: These should be checked regularly. They can become loose after a while in which case they should be tightened. They can become worn and not tightened properly, in which case they should be replaced.

MADE IN CHINA

CUSTOMER SERVICE

KMART AU: 1800 124 125

KMART NZ: 0800 945 995

TARGET AU: 1300 753 567