

anko

2 in 1 Floor and Hand Steamer User Manual



Model No.: JC-229
Rev 1

READ AND SAVE THESE INSTRUCTIONS

Note: The specifications and/or components of this appliance are subject to change without prior notice.

If any Accessories should fail during use, please call 1300 105 888 (Australia) or 09 8870 447 (New Zealand) for an immediate replacement. This will save you from returning the product to the store.

If we can assist you in any other way, please feel free to contact us.

1	Warnings	4
2	Safety Direction	4
3	Recommended Floor Surfaces.....	5
4	Transporting your Steam Mop / Hand Steamer	6
5	Components.....	6
6	Tools	7
7	Tool Suggested Uses	8
8	Assembly – As a Steam Mop.....	8
9	Attaching the Floor Head.....	10
10	Micro Fibre Pad.....	11
11	Operation – As a Steam Mop.....	11
12	Steam Rate	13
13	Using on carpets.....	14
14	Operation – As a Hand Steamer	15
15	Steam Rate	17
16	Window Squeegee	18
17	User Maintenance	19
18	Cleaning the Micro Fibre Pad & Steamer Cloth	19
19	Reduced Steam Flow.....	19
20	Cleaning the Steam Mop / Hand Steamer / Tools	20
21	Cord Storage	20
22	Wall Mount Storage	21
23	Troubleshooting	22
24	Warranty Against Defect.....	23

READ AND SAVE THESE INSTRUCTIONS FOR FUTURE REFERENCE

1 Warnings

Before using this appliance, read and follow all warnings and instructions in this manual, even if you are familiar with this product.

This appliance is not intended for use by persons (including children) with reduced physical, sensory, or mental capabilities, or lack of experience and knowledge unless they have been given supervision or instruction concerning the use of the appliance by a person responsible for their safety.

Children should be supervised to ensure that they do not play with the appliance.

If the supply cord is damaged, it must be replaced by the manufacturer, its service agent, or similarly qualified persons to avoid a hazard.

The liquid or steam must not be directed towards equipment containing electrical components, such as power boards or the like.



STEAM: Danger of Scalding. To avoid scalding, **DO NOT** touch hot surfaces or the steam nozzle during or just after use.

DO NOT use in swimming pools, etc. containing water.

The appliance must be unplugged after use and before cleaning and carrying out user maintenance on the appliance.

2 Safety Direction

Please read this instruction manual carefully before first use. Keep this instruction manual for future reference.

DO NOT leave the appliance unattended when in use, hot or producing steam.

Take care that children cannot touch the appliance when the appliance is hot and or producing steam, and make sure they cannot pull the mains cord.

DO NOT direct the steam towards persons, animals or equipment containing electrical components, such as the interior of ovens.

To protect against the risk of electric shock, do not immerse the appliance, cord, or plug in water or other liquids.

Take care as burns can occur from touching hot parts, hot water, or steam.

DO NOT use near sinks, baths or showers containing water or running water.

Disconnect the plug from the wall socket and let cool before changing the micro fibre cleaning pad.

This appliance must be earthed. The use of an Earth Leakage Safety Switch is highly recommended. If unsure, consult an electrician.

DO NOT use without the microfibre cleaning pad fitted.

DO NOT store or use the appliance near or in high temperature areas.

DO NOT run over the power cord with the Steam Mop.

DO NOT use the appliance if the power cord is damaged. Do not repair by yourself.

ONLY for domestic use. Industrial or commercial use invalidates the warranty.

Caution: Steam will continue to be emitted from the unit for approximately 10 seconds after the trigger has been released. This is just the residual pressure within the boiler venting.

3 Recommended Floor Surfaces

This product can be used for cleaning floor surfaces such as sealed wooden floors, ceramic tiles, granite, marble flooring, including some types of carpet and Vinyl.

It is strongly advised to always test a section of the flooring material in an out-of-sight area first to ensure the surface to be cleaned is not damaged by the steam.

Always follow the floor manufacturer's cleaning instructions. If unsure, **DO NOT USE!**

NOTE: This steam mop should not be used on surfaces with soft or heat-sensitive coatings like wax, enamels, oils, etc.

IMPORTANT: DO NOT use on unsealed hardwood or unglazed ceramic surfaces.

Surfaces that are not properly sealed may be warped or damaged by exposure to heat and moisture.

Care should also be taken when steaming sealed hardwood floors, as prolonged exposure to steam in a single spot may cause damage and discolouration.

To avoid this, keep the Steam Mop in constant motion on these surfaces, and place it on an old towel or similar when finished.

Extremely rough textured floors may tear or damage the Microfibre Pad.

DO NOT use on windows, tables or other types of furniture or fixtures.

DO NOT add any other agents into the water tank, such as rust removers, odour counter-reacting agents, alcohol, cleaners, solvents, detergents, etc. as this may cause serious injury to the user and may damage the appliance and floor surface.

4 Transporting your Steam Mop / Hand Steamer

To move your Steam Mop / Hand Steamer from room to room, unplug the unit and carry using the handle.

Never pull or carry the Steam Mop / Hand Steamer by its cord.

5 Components

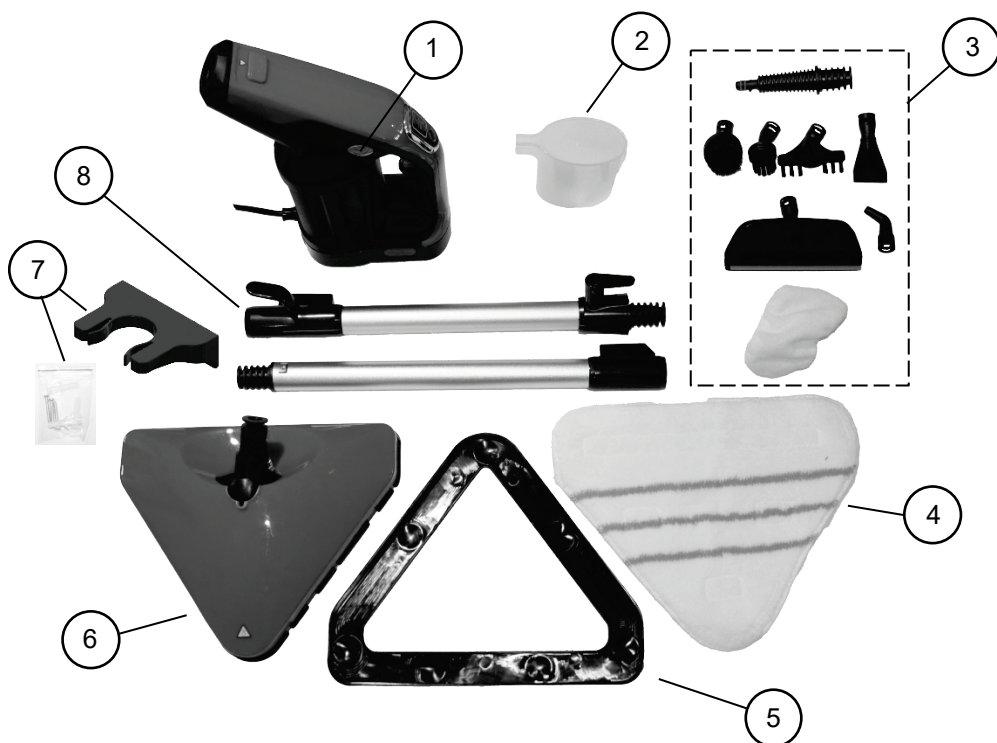

1	On / Off Button	5	Carpet Slider
2	Water Beaker	6	Steam Head
3	Tools	7	Wall Mount Bracket, Screws, Wall Plugs
4	Microfibre Pad	8	Extension Tubes

6 Tools

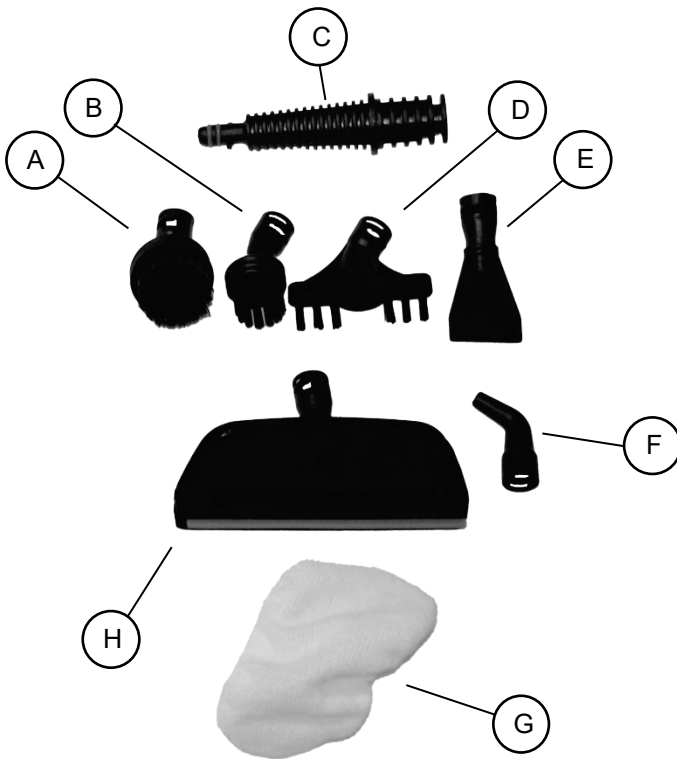

A	Large Scrub Brush	E	Scraper Tool
B	Small Scrub Brush	F	Angle Nozzle
C	Extension Spigot	G	Steamer Cloth – Use on Window Squeegee
D	Grout Cleaning Tool	H	Window Squeegee

7 Tool Suggested Uses

Item	Description	Suggested Usages
A	Large Scrub Brush	Used for gently cleaning Ovens, stove tops, bathtubs, taps, tiles, grout, toys, etc
B	Small Scrub Brush	Used for gently cleaning Ovens, stove tops, bathtubs, taps, tiles, grout, toys, etc
C	Extension Spigot	This must be fitted to the Hand Steamer for attaching the tools.
D	Grout Cleaning Tool	Used for gently cleaning Tile Grout
E	Scraper Tool	Used for scraping stubborn dirt whilst steaming
F	Angle Nozzle	To help shift dirt in hard-to-reach areas around Stove tops, around tap bases, grout, sinks, etc.
G	Steamer Cloth	To be attached to the Window Squeegee Head (item H) and is used for steaming Curtains and Upholstery.
H	Window Squeegee	Used for cleaning windows, shower screens etc., or for cleaning smooth surfaces with the Microfibre Finger Pad fitted

8 Assembly – As a Steam Mop

To use as a Steam Mop, some assembly and arranging of components are required.

- The Extension tubes need to be assembled and then fitted into the end of the Steam Unit.



- To do this, grasp the Extension Tube, insert the end small end of one tube into the end of the other extension tube as shown below, and push in hard, all the way, until it locks in place.

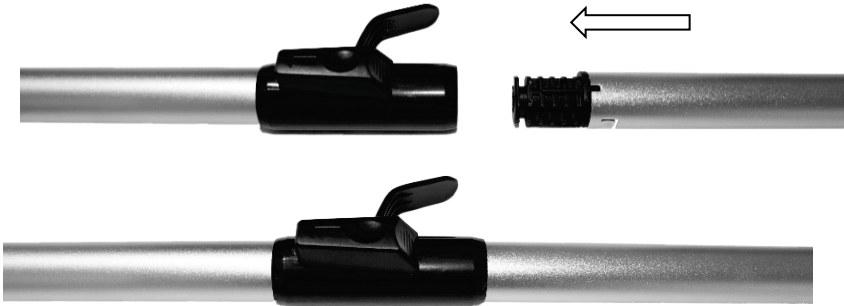

- Next, the assembled Extension Tubes need to be assembled into the Steam Unit.
- To do this, grasp the assembled Extension Tubes, insert the small end of the tube into the opening of the Steam Unit, and push in hard, all the way until it locks in place as shown:

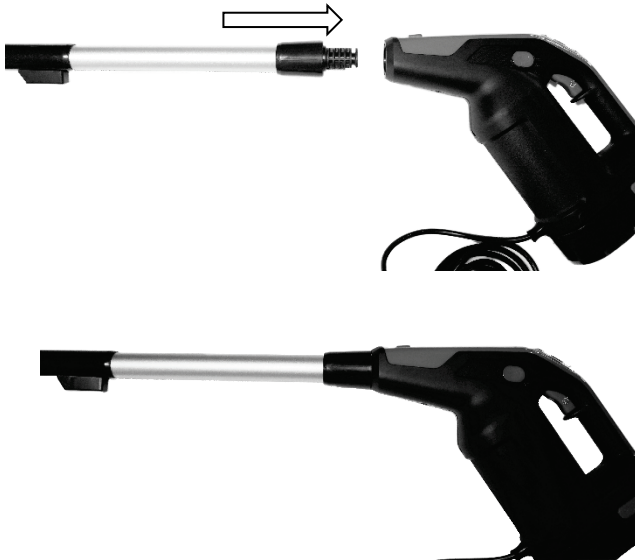

WARNING: The steam head attachments are extremely HOT during and after use. Wait for the product to cool down before touching and removing components.

- To remove the Extension Tube assembly, press the large button on the top of the Steam Unit and at the same time, pull the Extension Tubes straight out.

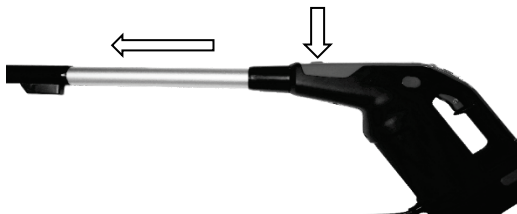

9 Attaching the Floor Head

- To do this, place the floor head on the floor with the spigot facing up, position the end of the Extension Tube over the spigot of the floor head and push down hard onto the neck until it clips in place.



WARNING: The steam head attachments are extremely HOT during and after use. Wait for the product to cool down before touching and removing components.

- To remove the Floor Head, on the back of the Extension Tube, slide the lock down and at the same time pull the Extension Tube and Floor Head apart.



10 Micro Fibre Pad

- To fit the Micro Fibre Pad, place the Micro Fibre Pad on the floor with the plain face facing up.
- Lift the steam mop up and position centrally over the Micro Fibre Pad and then lower down applying a small amount of downward pressure.

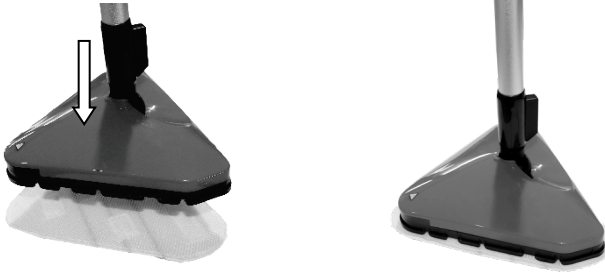

- To remove the Micro Fibre Pad, ensure the steam mop is unplugged, empty of water and cool, then grasp the edge of the micro pad and peel off.

11 Operation – As a Steam Mop

Important: Always switch off and unplug the appliance when refilling the water tank, or when not in use.

Ensure the Micro Fibre Pad is fitted before use. To prevent damage to the floor never use the steam mop without the micro fibre pad fitted.

- Remove the water tank by pressing the two side buttons inward and pulling the water tank straight out as shown.

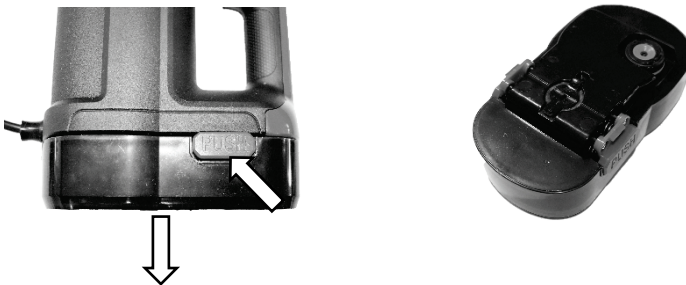

- Pull the plug out and fill the water tank to the very top using the supplied water beaker, then refit the plug ensuring it is firmly secured.



- The Water tank can now be refitted to the Hand Steamer Unit by aligning with the water tank recess and push in firmly until the two side latches clip shut.

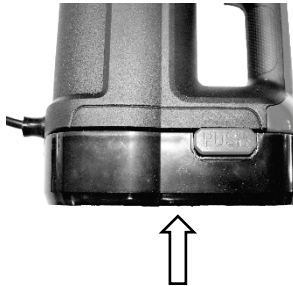

IMPORTANT: Read the section on “Recommended Floor Surfaces” before use.

- Ensuring the power cord is fully unwound, insert the plug into the power point and switch on the power point.
- Press the On /Off Switch, located on the side of the Steam Unit, to switch the unit on.



- The display will illuminate Red colour indicating the unit is heating, and the indicator light above the word “High” will illuminate.

Note: the default setting is “High” Steam rate.

- After approximately 20 – 30 seconds, depending on the water temperature, the display will change to a Blue colour indicating the unit is ready to use.



Note: A small amount of water may initially be ejected from the base when heating starts. This is normal.

- Grasp the handle and then squeeze the Steam Trigger to start the steaming, and as soon as the steam starts to be generated, immediately start to mop your floor with the same back and forward action as if vacuuming the floor.

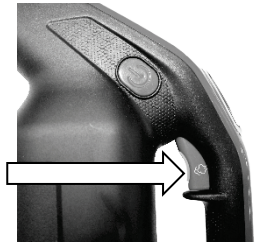

IMPORTANT!

Never allow the steam mop to rest in one spot while the steam is on as this may damage the floor surface.

Never leave the Steam Mop unattended while switched on. If leaving unattended, always switch off the Steam mop with the On / Off Button, located on the side of the Hand Steamer unit, or better still, switch off and unplug from the power point.

Caution: Steam will continue to be emitted from the unit for approximately 10 seconds after the trigger has been released. This is just the residual pressure within the boiler venting.

12 Steam Rate

- If you find during use that there is too much steam, you can reduce the steam rate by Pressing the Steam Button located on the Indicator Light Panel.



- Press once and the Steam Rate will change to “Medium” rate.
- Press again and the Steam Rate will change to “Low” rate.
- Press again and the Steam Rate will cycle back around to “High” rate. and so on.

13 Using on carpets

This appliance is supplied with a Carpet Slider which allows you to use the Steam Mop on carpets.

- To use this accessory, place the Carpet Slider on the carpet and then place the Steam Mop Head (with Micro Pad fitted first) into the frame.



- Push and pull the Steam Mop over the carpet as if you are vacuuming the floor.
- To remove the Carpet Slider, lift the Steam Mop up and out of the Slider.



CAUTION: Take care when touching the Carpet Slider as it may be hot after use.

14 Operation – As a Hand Steamer

- With the Hand Steamer Unit switched off and unplugged, remove the Floor Head and extension tubes from the Hand Steamer Unit as shown previously.
- Fill the water tank as described earlier under the section “Operation – As a Steam Mop”.
- Choose the accessory tool that you wish to use and attach it before switching on.

Note: Refer to the “Tool Suggested Uses” section near the front of this manual for suggestions on what each tool can be used for.

- To attach the small tools or Window Squeegee, first fit the “Tool Spigot”. Align the Tool Spigot with the hole in the front of the Hand Steamer and then push in all the way until it locks in place as shown:

Note: there is a flat surface on the underneath which needs to align with the flat surface in the hole.



WARNING: The steam head attachments are extremely HOT during and after use. Wait for the product to cool down before touching and removing components.

- To Remove the Tool Spigot, press the release button, located on the top and firmly pull the Tool Spigot straight out.

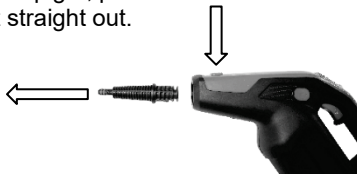

- With the Tool Spigot fitted, take your desired tool, and attach it to the front of the Tool Spigot.
- Align the slots in the back of the tool with the tabs on the front of the Extension Tool Spigot then push on all the way as shown:

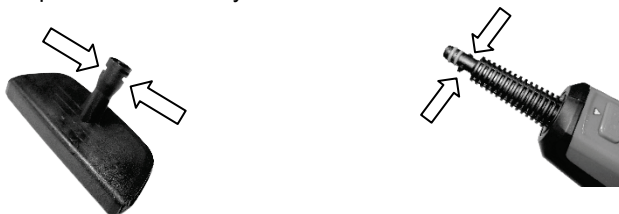

- Then rotate the tool clockwise to lock onto the tabs.



- To remove the tool, rotate the tool anticlockwise and firmly pull it straight off.

Note: This method is the same for all the small tools.

- With the required tool fitted and locked in place, ensure the power cord is fully unwound, then insert the plug into the power point and switch on.
- Press the On /Off Switch, located on the side of the Steam Unit, to switch the unit on.



- The display will illuminate Red colour indicating the unit is heating, and the indicator light above the word “High” will illuminate.

Note: the default setting is “High” Steam rate.



- After approximately 20 – 30 seconds, depending on the water temperature, the display will change to a Blue colour indicating the unit is ready to use.

Note: A small amount of water may initially be ejected from the base when heating starts. This is normal.

- Grasp the handle and then squeeze the Steam Trigger to start the steaming, and as soon as the steam starts to be generated, immediately start to use the steam cleaner.

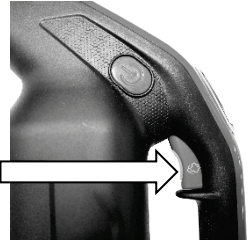

IMPORTANT!

Never continuously steam in one spot as this may damage the surface being steamed.

Never leave the Hand Steamer unit unattended while switched on. If leaving unattended, always switch it off with the On / Off Button, located on the side of the Hand Steamer unit, or better still, switch off and unplug it from the power point.

Caution: Steam will continue to be emitted from the unit for approximately 10 seconds after the trigger has been released. This is just the residual pressure within the boiler venting.

15 Steam Rate

- If you find during use that there is too much steam, you can reduce the steam rate by Pressing the Steam Button located on the Indicator Light Panel.



- Press once and the Steam Rate will change to “Medium” rate.
- Press again and the Steam Rate will change to “Low” rate.
- Press again and the Steam Rate will cycle back around to “High” rate. and so on.

16 Window Squeegee

The Window Squeegee can be used in two different ways.

- a. To use to clean windows or shower screens etc., fit the Window Squeegee to the “Tool Spigot” as described previously.

Switch on and when the steam starts, start to move the Window Squeegee up and down the glass surface.

Use the rubber strip on the squeegee to remove the excess water from the glass surface starting at the top and dragging downward.

Clean up the dirty water with a cloth.

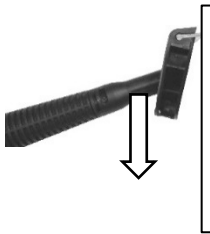

When finished, turn off the hand steamer and allow it to cool before touching the tool.

- b. To use the Squeegee to steam curtains and upholstery, fit the Steaming Cloth to the Squeegee as shown and then fit to the Hand Steamer.



Note: Read the curtain and upholstery care label before proceeding to ensure steam cleaning is permissible.

With the steam turned on, place the Steam Cloth on the fabric surface and move the squeegee up and down to remove the creases.

When finished, turn off the hand steamer and allow it to cool before touching the tool.

IMPORTANT: Only Steam the fabric when facing the steam jet away from yourself or any bystander or pets.

17 User Maintenance

WARNING: The appliance must be switched off and the plug must be removed from the power point before any maintenance, cleaning or replacement of the Microfibre Pad or Tools etc.

NOTE: To maximise the performance of your steam mop / hand steamer, you should clean the Microfiber Pad regularly.

18 Cleaning the Micro Fibre Pad & Steamer Cloth

The Microfibre Pad and Steamer Cloth must be cleaned regularly for the best cleaning performance.

Simply wash them in warm mild soapy water, rinse in clean fresh cold water and let dry.

The Micro Fibre Pad and Steamer Cloth may be washed in a washing machine on a Normal Wash.

DO NOT scrub or Tumble Dry the Micro Fibre Pad or Steamer Cloth.

19 Reduced Steam Flow

Should there be a build-up of scale etc. the flow of steam will be restricted and there may be small particles of scale left on the surfaces being cleaned.

The scale needs to be cleaned away as follows:

Disconnect from the power supply and wait for the appliance to fully cool down.

Do Not leave the steamer unattended during the scale removal process and/or while in use.

Cleaning solution:

- Prepare a solution of 1/3 white vinegar and 2/3 tap water and add to the water tank.
- Fit the extension tubes and floor head to the Hand Steamer then position and secure the steam mop over a sink. Ensure steam released from the mop head is aimed into the sink and cannot do any harm to surrounding surfaces, objects, pets, people, etc.
- Plug the unit in and switch on. Wait for approx. 20 - 30 seconds for the unit to heat and start the steam.

- Let the mop produce steam until the vinegar/water solution is used up.
- Repeat the above procedure as many times as necessary until a normal steam flow rate is achieved.
- After cleaning, the water tank and pipes etc. need flushing out with clean water.

To do this, fill the water tank with fresh clean water and wait for approx. 20 - 30 seconds for the unit to heat and start to steam. Allow all the water to be used up to ensure a good flush.

Note: After each limescale removal we recommend performing a test clean on a suitable isolated area to ensure that there is no debris left in the system.

20 Cleaning the Steam Mop / Hand Steamer / Tools

Do not clean the Steam Mop / Hand Steamer or components with petrol or any other flammable liquids, solvents, etc.

Use only a moist cloth and mild detergent for cleaning the Steam Mop / Hand Steamer.

Clean only the outside of the Steam Mop / Hand Steamer.

After cleaning, wipe off the moisture with a dry cloth.

Do Not place the Steamer unit in water to clean.

Do Not clean components or tools etc. in a dishwasher.

21 Cord Storage

- After you have finished using the appliance, switch off and unplug from the power point and allow the appliance to fully cool down.
- When cool, empty the water tank.
- Remove the microfibre pad and clean it. (refer to User Maintenance section)
- If set up as a Steam Mop, the power cord can be wound onto the storage hooks on the side of the extension tubes as shown.



- To quickly release the power cord, the top hook can be rotated to allow the power cord to slip off as shown below. Rotate the hook back before winding the cord back on.

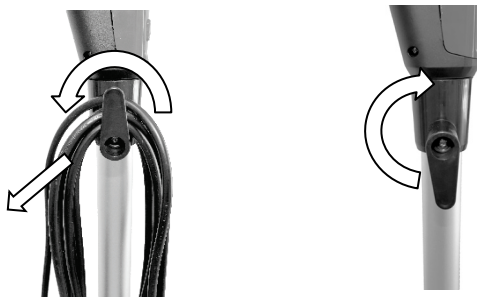

- If storing away as a Handheld Steamer without the extension tubes fitted, loosely coil the power cord, and lay next to the unit.

22 Wall Mount Storage

There is a Wall Bracket supplied with screws and wall plugs for attaching to the wall. To install the Storage Bracket, position the Bracket on the wall at a suitable height where if the Steam Mop Extension Tubes and Floor head are fitted, the floor head will not be touching the floor. Approximately 1000mm from the floor to the top of the mounting bracket.

Mark the screw holes through the Bracket onto the wall.



If mounting on a timber or brick wall, using a suitable drill bit (wood drill bit for a timber wall, or masonry drill bit for brick / concrete walls, drill holes Ø6mm and 25 - 35mm deep.

Insert the straight plastic wall plugs into each hole and gently hammer in until they are flush with the wall, place the Bracket over the holes then insert the screws and tighten up. Do Not Overtighten.

If mounting on a Sheet Plaster wall, use the screw-in Wall plugs.

Hang the vacuum cleaner as shown:

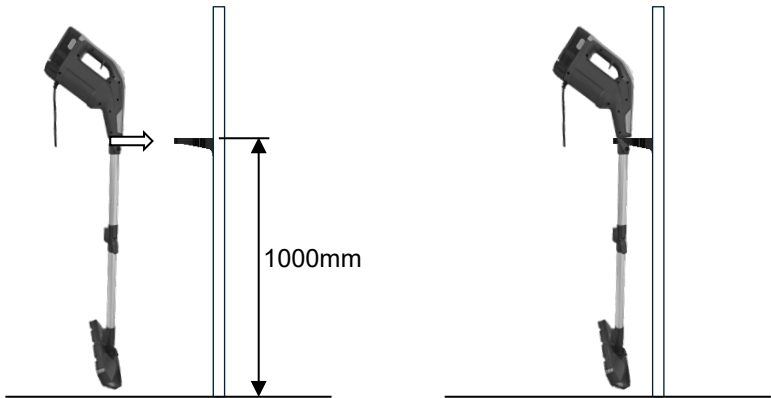

23 Troubleshooting

No Steam.	Power Not Switched On.	Switch On at power point and on the side of the Steamer Unit
	No Power to Power Point	Check your circuit breakers.
	The water has not heated up.	Allow approximately 20 – 30 seconds for the water to heat.
	No water in the tank.	Add water to the water tank.
	Blocked Steam Path	Clean the steam path
A small amount of water is ejected instead of steam	This is normal when the element is heating up.	This is normal
Indicator Light will not come on.	Power Not Switched On.	Switch On at power point and on the side of the Steamer Unit
Steam runs out quickly, but water is still in the tank	The brass weight on the end of the water tube inside the water tank is not located at the bottom of the water tank.	With the water tank in a vertical position, tap the water tank with your hand to dislodge the brass tip so that it falls to the bottom of the water tank.
Steam continues when the Trigger has been released	This is normal. Steam will continue to be emitted from the unit for approximately 10 seconds after the trigger has been released. This is just the residual pressure within the boiler venting	
If all the above checks out and still the unit will not turn on, it could be the internal temperature safety fuse which has activated.		
If this occurs, call our customer service department for further instructions.		

24 Warranty Against Defect

12 Month Warranty

Thank you for your purchase.

Your new product is warranted to be free from defects in materials and workmanship for the period stated above, from the date of purchase, provided that the product is used in accordance with accompanying recommendations or instructions where provided. This warranty is in addition to your rights under the Australian Consumer Law. For New Zealand customers, this warranty is in addition to statutory rights observed under New Zealand legislation.

We will provide you with your choice of a refund, repair (where possible) or exchange (availability dependent) for this product if it becomes defective within the warranty period. The business will bear the reasonable expense of claiming the warranty. This warranty will no longer apply where the defect is a result of alteration, accident, misuse, abuse, or neglect.

Please retain your receipt as proof of purchase and contact our Customer Service Centre as listed below, for the entity you purchased this product from, for any difficulties with your product. Warranty claims and claims for expenses incurred in returning this product can be addressed to the respective Customer Service Centre.

Our goods come with guarantees that cannot be excluded under the Australian Consumer Law. You are entitled to a replacement or refund for a major failure and compensation for any other reasonably foreseeable loss or damage. You are also entitled to have the goods repaired or replaced if the goods fail to be of acceptable quality and the failure does not amount to a major failure.

Contact for Kmart purchases	Contact for Target purchases
Kmart Australia Ltd. C/- Customer Service Centre, 690 Springvale Road, Mulgrave Vic 3170 Customer Service: 1800 124 125 (Australia) or 0800 945 995 (New Zealand) or via Customer Help at kmart.com.au	Target Australia Pty Ltd. C/- Customer Service Centre, 2 Kendall Street, Williams Landing, Vic, 3027 Customer Service: 1300 753 567 or via Customer Help at target.com.au/help/contact-us

