

Bicycle Owner's Manual

Children's Bicycles

The following manual provides assembly and maintenance instructions, as well as a guide to safe usage of your new bicycle.



WARNING

- Read the complete Owner's Manual before starting the assembly of this bicycle.
- Rider of this bicycle must wear a helmet at all times.
- Assembly of this product should be carried out by an adult
- Pay attention to prevent the situation that body was napped or clothing was involved during using or maintenance.
- The bike is not suitable for the fitting of a luggage carrier and(or) a child seat.
- The permissible total weight of the rider plus luggage and the maximum total weight (bicycle+rider+luggage): 46kgs

Don't return this product to the store if you need replacement parts or have a question regarding assembly of this product. Please call our SERVICE CENTRE direct on

1800 632 792 (Australia)
0800 632 792 (New Zealand)



100 Keilor Park Dr, Tullamarine, 3043, Victoria.

Table of ContentsPage

Safety Information	3
Bicycle Identification	4
Fitting the rider to the bicycle	4
Rules of the road	5
Wet weather riding	6
Introduction to the manual	7
Front wheel and training wheel assembly	8
Training wheels assembly	8
Front Fender Assembly	9
Handlebar and Stem Assembly	10
Front Reflector Bracket Assembly	12
Rear Reflector Bracket Assembly	13
Spoke Reflectors	14
Seat Assembly	15
Pedal assembly and brake system	17
Brake pad replacement	21
Attaching accessories	21
Chain	22
Bicycle Care and Maintenance	23
Service checklist	24
Recommended torque	25
Tyres	26
Inspection on bearings	28
Parts order	29
Exploded diagram	29
Warranty	30

Owner's Safety Information and Responsibilities



During this manual you will read many WARNINGS, CAUTIONS or NOTES, please pay special attention to these throughout.

WARNING: This is shown with personal safety instructions, failure to follow these may result mechanical failure or damage.

CAUTION: This is shown with mechanical instructions; failure to follow these may result in injury to the rider or others.

NOTE: This is shown to highlight a specific point of interest, which will help in the assembly or maintenance of this bicycle.

The Owner's Responsibility

- If the bicycle was purchased unassembled, it is the responsibility of the owner to follow all the assembly and adjustment instructions exactly as written in this manual.
- If your bicycle was purchased assembled, it is the owners responsibility to read and make sure bicycle was assembled as shown in this manual.
- Know how to use all standard and accessory equipment on the bicycle.

WARNING This bicycle is made to be ridden by one rider at a time for general transportation and recreational use. It is not made to withstand the abuse associated with stunting and jumping.

Advice on the selection of a bicycle for children or people of short stature, that the seat position must be adjustable so that the feet of seated rider can reach the ground

A recommendation that significant mechanical repairs should be carried out by a skilled bicycle mechanic.

Bicycle Identification Record

Each bicycle has a Model / Serial Number stamped into the bottom of the frame. Write this number below to keep it for future reference. If the bicycle is stolen, give this number and description of the bicycle to the police.

You will also need this number if you orders parts or request service information.

Model / Serial Number.....

Purchase Date.....

Purchase Location.....

Model Name.....

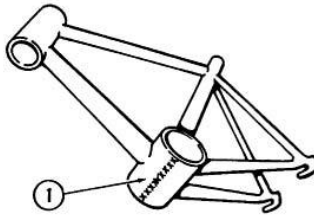

Fitting the Rider to the Bicycle

- ① The clearance between the rider's crotch and the top of the frame tube.
- ② The height from the highest point of the top tube to ground .
- ③ The height of rider's crotch.

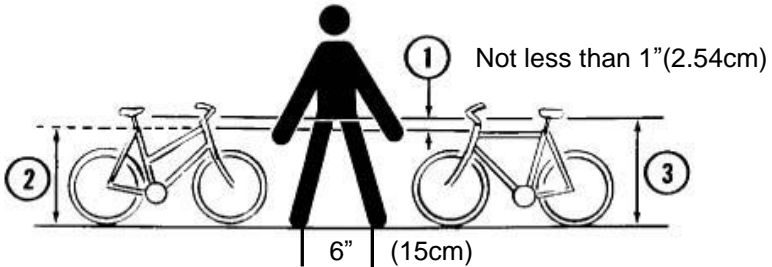

To determine the correct size of bicycle for the rider:

The correct frame size is the largest frame that the rider can automatically straddle keeping both feet on the ground and allowing 25.4mm(1 inch) clearance between the rider's crotch and the top of the frame tube (see illustration. Note ladies can use men's bicycle to determine their correct frame size. Rider must be able to straddle bicycle with at least 25.4mm (1 inch) clearance above the horizontal bar when standing.

Rules of the Road



WARNING Failure of the rider to obey the following “Rules of the Road” can result in injury to the rider or to others.

- Obey the road rules at all times, such as traffic signals, signs and giving way to pedestrians.

- Always wear a bicycle helmet that meets the local safety standards.

- Always ensure that appropriate footwear is worn whilst riding this bike. Lace up shoes with rubber soles, never ride barefooted or in sandals, and ensure that shoelaces are tied and kept out of the way of the wheels and drive system.

- Always ride in the same direction as the traffic. Never ride against traffic.

- Avoid the following hazards: drain grates, soft road edges, gravel or sand, pot holes or ruts, wet leaves, or uneven paving.

- When crossing railroad tracks do so carefully at a 90 degree angle to prevent loss of control.

- Do not carry packages or object that obstruct your vision or control.

- Do not carry any passengers.

- Do not ride with both hands off the handlebars.

- Use hand signals. Indicate intended actions, such as turning or stopping, by using appropriate hand signals.

- Apply the rear brake first, then apply the front brake. The front brake is more potent and if not used properly you may lose control and fall.

- Do not use items that may impede your hearing. Eg headphones

- Ride predictably and in a straight line.

Night Riding

- Avoid riding at night if possible, if you choose to ride at night:

- Purchase, install, and use a front and rear bicycle light.

- Make sure the reflectors of your bicycle are correctly positioned.
- Use a flashing rear light to improve visibility.
- Wear light-coloured reflective clothing, such as a reflective vest and reflective bands for your arms and legs.

Wet Weather

- Use extra caution in wet weather.
- Avoid sudden braking.
- Apply brakes sooner in wet conditions, as stopping distance increases in wet weather.
- Slow overall riding pace and approach corners more carefully.

Off-Road Riding

- Use extreme caution when not riding on pavement.
- Always wear correct safety equipment.
- Ride only on the trails.
- Avoid rocks, branches, or depressions.
- When approaching a descent, reduce speed, keep your weight back and low, and use the rear brake more than the front.
- Be sensitive to the environment, conscientious of the property on which you ride, and considerate of others you may meet on the trail.

Introduction and How to use this Manual

This owner's Manual is made for several different bicycles. The illustrations used are to provide examples and some may not look exactly like the parts of the bicycle, but the instructions are correct. In addition some of the parts shown might be optional and not part of your bicycle's standard equipment. If the bicycle has any parts that are not described in this manual, look for separate "*Special Instructions*" supplement that is supplied with the bicycle. Make sure the rear wheel is centered in the bicycle frame.

Unpacking

Remove the bicycle from and all parts from the carton. Do not dispose of the carton and packaging until you complete the assembly of the bicycle. This can prevent accidentally discarding parts of the bicycle.

NOTE: All of the directions (right, left, front, rear, etc) in this manual are as seen by the rider while seated on the bicycle.

Tools Needed for Assembly



15cm Adjustable wrench



25cm Adjustable wrench



Flat Blade Screwdriver



Phillips Screwdriver

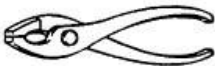

Slip Joint Pliers



Metric Allen Wrenches
(Needed on some models)



Torque Wrench

Step 1

Front Wheel Assembly

(Recommended torque is 25-32 Nm)

1. Remove plastic axle protectors off the wheel axle and dispose of them, they are for shipping purposes only.
2. Slide wheel axle into the open ends of the Front fork.
3. Slide a wheel retainer (6) onto each end of the axle. Ensure the tab of each retainer is in the hole in the frame.
4. Install an axle nut (7) loosely onto each end of Axle.
5. Center the wheel in the fork and tighten both nuts securely to the recommended torque, alternating from one to the other.

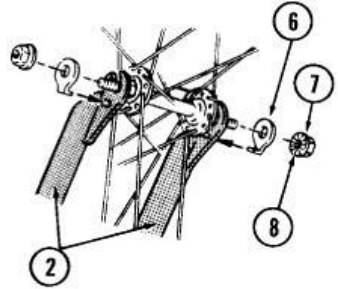

NOTE: Some models are shipped with the reflector installed facing between the front forks to protect fork when shipping. If so please remove reflector and rotate it 90 degrees and install again before inserting the wheel between the front forks.

Step 2

Training Wheels

1. Attach the legs to the bicycle frame:
 - Put the alignment insert (1), a leg (2), and a nut (3) on each end of the rear wheel axle (4)
 - Make sure the tab of the alignment insert (5), is to the rear of the axle and in the slot (6) of the frame
 - Make sure both training wheels are the same distance from the ground
 - Tighten the nuts securely

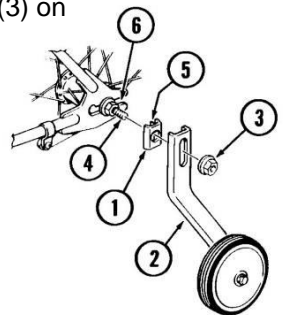

Operation



WARNING: Before each ride, make sure both nuts are tight. Also make sure both training wheels are the same distance from the ground.

As your child's ability and balance improve, you may raise or remove the training wheels.

- To adjust the training wheels, loosen the nut, slide the leg to the correct position, and retighten the nut.
- To remove the training wheels, remove the nut, leg, and alignment insert.

Step 3

Front Fender Assembly

If your bike comes with a front fender, please follow these steps.

1. Place the fender in the fork with the upper mounting tab on the rear side of the fork.
2. Secure with mounting bolt, lock washer and Nylon nut.
3. Tighten each screw sufficiently to hold the fender in place, be careful not to over tighten and strip the screw threads.



Step 4 Handlebar and Stem Assembly

Assembly

1. Assemble the stem to the fork:

Inside mount style

- Insert the stem into head set lock nut.
- The handle bar clamp should face towards the front of the bicycle

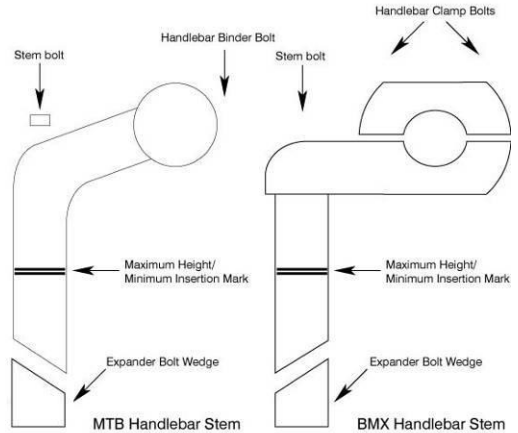

WARNING: Etched on the stem is a mark about 65mm up from the bottom with the words ‘max height’ or “minimum insertion”. Never ride a bicycle if the stem has been raised so that this mark can be seen.

- At this stage tighten stem bolt just enough to hold it in position.

2. Tighten the stem bolt

Recommended torque Single Bolt is 21-25 Nm, four bolt type (M8 bolt:18-20Nm; M6 bolt:9-13Nm)



WARNING: Handlebar grips and tube end plugs should be replaced if damaged, as bare ends have been known to cause injury. Please check condition of grips and bar ends before every ride.



WARNING: Do not over tighten the stem bolt. Over tightening the stem bolt can damage the steering system and cause loss of control.

- Make sure the stem is aligned with the front wheel and tighten the stem bolt

- Position the handlebars in the desired position of the rider. Ensuring they are facing the correct direction.



WARNING: If the handlebar clamp is not tight enough, the handlebar can slip in the stem. This can cause damage to the handlebar or stem, and can cause loss of control.

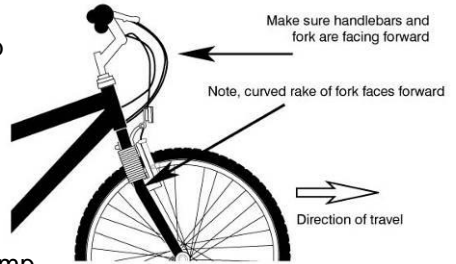

- Tighten the bolt(s) of the handlebar clamp

ALL BOLTS NEED TO BE TIGHTENED EQUALLY

3. Test the tightness of the stem bolt and handlebar clamp:

- Brace the front wheel between your knees and try to move the handlebars up and down and from side to side. The handlebars are secure within the stem and the stem within the fork steer tube if no movement is detected when applying turning pressure.

4. Put the handlebar parts in the correct position:

- Put the brake lever and shift control in a position that is comfortable to the rider
- Make sure the brake levers do not touch the grip or the shift control during use
- If you have a grip shift control, the clamp screw for the control is in a recess on the side on the end nearest the stem.
- Tighten the clamp screw of each brake lever
- Move each bar end around the handlebar to a position that is comfortable to the rider
- Tighten the clamp bolt of bar end securely.

5. Test the tightness of the handlebar ends:

- Hold the bicycle stationary and try to move the ends of the handlebar ends forward and backward
- If either handlebar end moves on the handlebar, reposition it and tighten the clamp bolt tighter than before
- If the handlebar moves in the stem, loosen the stem clamp, reposition the handlebar, and tighten the handlebar clamp tighter than before
- Do this test again, until the handlebar ends and the handlebar do not move.

6. Put each brake lever in the correct position that is comfortable to the rider.

- Tighten the clamp screw of each brake lever.

Operation



WARNING: If you choose to ride with your hands on the handlebar ends, be careful. You will not be able to stop quickly because your hands are farther away from the brake levers.

If your bike has reflectors, please follow steps 5 and 6
Step 5
Front Reflector Bracket and Clear Reflector Assembly

Front Reflector Bracket Installation

Make sure the front reflector is vertical (perpendicular to the ground)

The front reflector bracket will mount on the handlebar.

Handlebar Mount

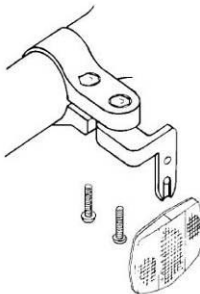

Handlebar Mount

Assemble to the handlebar:

- Put the clamp (1) as near the handlebar stem as possible

NOTE: make sure the bracket points towards the ground.

- Hold the reflector in this position and tighten the screw(s) (3)

Operation and Maintenance



WARNING: For your own safety, do not ride this bicycle if the reflectors are incorrectly installed, damaged, or missing. Make sure the front and rear reflectors are vertical. Do not allow the visibility of the reflectors to be blocked by clothing or other articles. Dirty reflectors do not work well. Clean the reflectors, as necessary, with soap and a damp cloth. If necessary, adjust the angle of the reflector bracket so the reflector is vertical (perpendicular to the ground).

Rear Reflector Bracket and Red Reflector Assembly

Step 6

Rear Reflector Bracket Installation

Make sure the rear reflector is vertical (perpendicular to the ground)

The rear reflector bracket will mount on the seat post, post clamp, or rear brace. Some models may already have the brackets and reflectors installed. If the reflector is not installed, refer to the “Rear Reflector Bracket and Red Reflector Assembly” Section.

Assemble the reflector bracket to the seat post:

- Make sure the red reflector (4) is vertical, points toward the rear of the bicycle, and has 7.5cm of clearance between the top of the seat and the top of the red reflector.
- Hold the red reflector in this position and tighten the screw(s).



WARNING: For your own safety, do not ride the bicycle if the reflectors are incorrectly installed, damaged, or missing. Make sure the front and rear reflectors are vertical. Do not allow the visibility of the reflectors to be blocked by clothing or other articles. Dirty reflectors do not work well. Clean the reflectors, as necessary, with soap and a damp cloth.

Spoke Reflectors

Your bicycle may have one of the following styles of spoke reflectors. Many bicycles will come with the wheel reflectors already attached. If your bicycle does not have the wheel reflectors attached please follow below steps.

Assemble a reflector between the spokes of each wheel:

NOTE: If the bicycle has a wheel disc, put the reflector in the notch of the wheel disc. The notch is shaped so the spoke reflector fits into it.

- Make sure the center of the each reflector (1) is less than 76mm from the inside edge of the wheel rim (2)
- Make sure the curve of the reflector (3) matches the curve of the wheel rim (4)
- Install bolt and nut, then tighten.

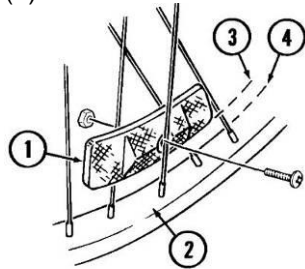

Operation and maintenance



WARNING: For your own safety, do not ride the bicycle if the reflectors are incorrectly installed, damaged, or missing. Make sure the front and rear reflectors are vertical. Do not allow the visibility of the reflectors to be blocked by clothing or other articles. Dirty reflectors do not work well. Clean the reflectors, as necessary, with soap and a damp cloth.

Step 7 Seat Assembly



NOTES: If you accidentally drop the seat post into the seat tube, you may not be able to remove it.

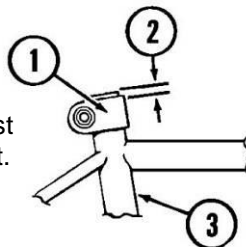

1. Install post clamp on the seat tube:

- Put the clamp on the seat tube. Push the clamp (1) down so you can see 1.6mm (2) of the seat tube (3) above the clamp.

NOTE: Some post clamps are welded in position and cannot be removed.

- If the post clamps has a raised edge, make sure the raised edge is against the top of the seat tube.

2. Attach the seat to the seat post or seat pillar:

(Recommended torque is 12-17 Nm)

- Position the seat post into the clamp under the saddle.
- Tighten the seat clamp so the seat stays on the seat post
- If the seat clamp has nuts on each side, tighten both nuts equally

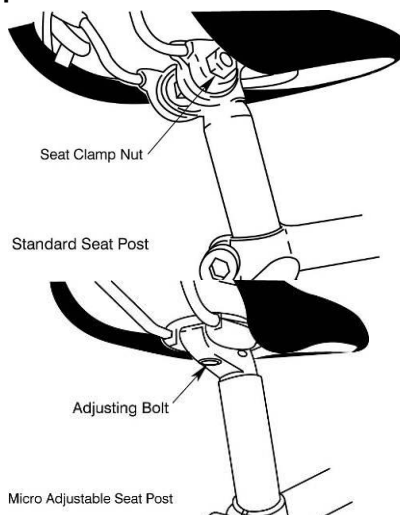

3. Attach the seat post into the seat tube

(Recommended torque is 15-19 Nm)

(Quick release recommended torque 15-25NM)

- Point the seat forward and insert the seat post into the seat tube.
- Make sure you can't see the "MIN-IN" minimum insertion mark of the seat post above the seat tube.
- If a seat post clamp is included slide this

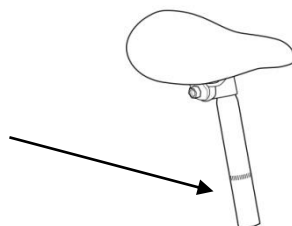

onto the seat post.

- Put the seat at a comfortable height for the rider.



WARNING: Never ride a bicycle with the minimum insertion mark visible on the seat post. Doing this may damage the seat post, the frame or cause injury to the rider.



WARNING: The red reflector must be vertical, point straight toward the rear of the bicycle, and have three inches of clearance between the top of the seat and the top of the red reflector.

- Tighten the bolt to the recommended torque.

4. Test the tightness of each the clamp and the post clamp:



WARNING: Every time you loosen the quick release mechanism, make sure the red reflector is correctly positioned if the reflector is mounted on the seat post or seat pillar.

- Try to turn the seat side-to-side and to move the front of the seat up and down
- If the seat moves you need to further tighten the binder bolt
- Loosen the seat clamp
- Put the seat in the correct position and tighten the seat clamp tighter than before
- Do this test again, until the seat does not move in the seat clamp
- If the seat post moves in the seat tube:
- Loosen the bolt and nut
- If you have a quick release lever, move it to the “open” position
- Put the seat in the correct position and tighten the bolt and nut or quick release tighter than before

- If you have a quick release lever, move the lever to the “close” position
- Do this test again, until the seat post does not move in the seat tube.

Step 7 Pedal Attachment

(Recommended torque is 24-30 Nm)



CAUTION: There is a right pedal marked “R” and a left pedal marked “L”. Please ensure you assemble them on the correct side.

The pedal marked “R” has right-hand threads. Tighten it in a clockwise direction.

The pedal marked “L” has left hand threads. Tighten it in a counterclockwise direction.

1. Turn the right pedal marked “R” (1) into the right side of the crank and the left pedal marked “L” (2) into the left side of the crank.

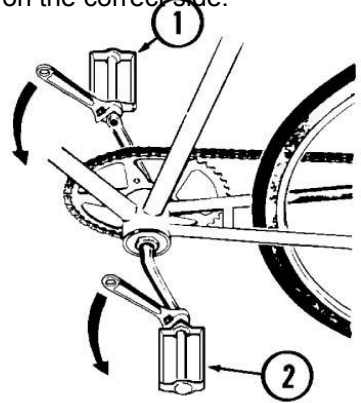

2. Tighten the pedals:

- Make sure the threads of each pedal are fully into the crank
- Tighten both pedals to the recommended torque

Brake Systems

Coaster Brake

Operate the coaster brake as follows:

- Push the pedals backward to move the chain backward
- The chain activates the coaster brake mechanism that is inside the rear wheel hub
- As you push the pedals backward with increasing force, the braking action of the coaster brake increases.

If your bicycle has a caliper brake(s) in addition to the coaster brake, always use the coaster brake as the main brake to stop the bicycle.

- When you ride the bicycle the first time, test the coaster brake and practice using it at a low speed in a large level area that is free of obstructions.
- Always try to brake while going in a straight line. If you must brake while turning; when the pavement is wet; or when the pavement is covered with sand, gravel, or leaves, start to brake sooner than normal and apply the brake intermittently to reduce the chance of skidding.
- Be careful when riding downhill or at a high speed because as your speed increases, a longer distance to stop the bicycle will be necessary. Slow for curves because too much speed can force you to make a turn that is too wide.
- Have the coaster brake repaired by a bicycle service shop the first time you notice that it does not stop the bicycle quickly and smoothly or just does not work as well as it has in the past.



WARNING

- Learn to brake properly so that you are ready to stop quickly in an emergency. The front brake can provide much greater stopping power than the rear brake, but jamming on the front brake too hard in an emergency can lift the rear wheel and throw the child over the handlebars. Practice applying the front brake hard but not so hard that the rear wheel starts to lift or skid. Braking on slippery surfaces, curves, and steep downgrades requires additional skill and care.

Maintenance

Every year, more often if you ride in dusty or dirty conditions, have a bicycle service shop clean and lubricate the parts of the coaster brake that are inside the rear wheel hub.

Hand Controlled brakes.

For safe riding it is crucial that your bicycle's brakes function correctly. With use the bicycle's brake pads wear and the control cables stretch. Consequently, prior to every ride the brakes should be inspected and adjusted as necessary to ensure proper operation



WARNING: A bicycle should never be ridden unless the brakes are working correctly.

Take care when using the front brake. Applying it abruptly or excessively may throw the rider over the handlebars, potentially causing serious injury.

Inspection

The brake levers and the brake pads are the two main components that need to be checked to ensure they are functionally correctly.

Prior to every ride inspection of the brake pads is recommended. The brake pads must be centered, with approximately 1.5mm-2mm clearance between each pad and the rim when the brakes are not in use. Test that when the brakes are applied that the brake pads squeeze the rims sufficiently to stop the bike. Replace the brake pads if the grooves or pattern has worn away from the surface. Ensure the brake pads are firmly secured before every ride and at least every three months check the tightness of the numerous bolts and nuts supporting the brake pads.

Adjustments before riding



WARNING: You must adjust your front and rear brakes before riding.

1. Put the brake shoes in the correct position:

- Loosen the nut (10) of each brake shoe
- Adjust each brake shoe so it is flat against the rim and aligned with the curve of the rim
- Make sure each brake shoe does not rub the tyre
- If the surface of the brake shoe has arrows, make sure the arrows point toward the rear of the bicycle
- Hold each brake shoe in position and tighten the nut.

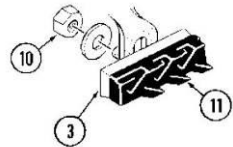

2. Test the tightness of each brake shoe:

- Try to move each brake shoe out of position
- If a brake shoe moves, do Step 1 again, but tighten the nut tighter than before
- Do this test again, until each brake shoe does not move.

3. Stretch the cable:

- Hold both brake shoes against the rim
- Loosen the cable clamp

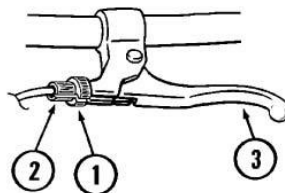

- Pull the cable tight and tighten the cable clamp



WARNING: Do not over tighten the cable clamp. Over tightening the cable clamp may cut the cable and cause injury to the rider or to others.

- Squeeze each brake lever firmly 20 times
- Hold both brake shoes against the rim and loosen the cable clamp
- Pull the cable tight and tighten the cable clamp

Lubrication (caliper brakes)

Lubricate the brake lever and the caliper pivot at least every three months with 2-3 drops of light oil. This will help to limit the wear and tear and ensure smooth operation. At least every six months remove the cables from their casings and grease along the entire length. Prior to fitting any new cable, always apply grease.

Adjustments – Sidepull calipers

To make minor brake adjustments use the barrel cable adjuster, usually found at the upper cable arm. Use the following outline as a guide.

1. Squeeze the brake pads against the rim and loosen the lock nut
2. Set the adjuster so there is approx 1.5mm-2mm clearance between the brake pedal and the rim.
3. Re-fasten the lock nut

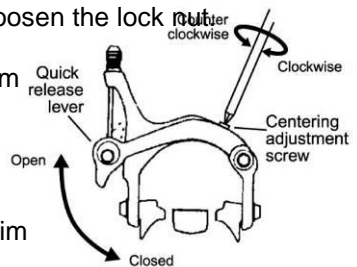

If the clearance between the brake pad and the rim cannot be set to 20mm or less using this method, the cable length may need to be adjusted. To do this

1. Screw the barrel adjuster in completely.
2. Press the pads against the rim.
3. Un-fasten the cable anchor bolt and use pliers to pull the cable through.
4. Re-fasten the cable anchor bolt.

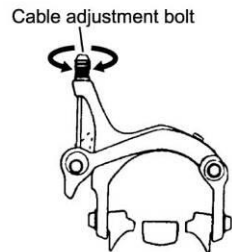

5. Test the brake lever by applying full force, and the barrel adjuster to make any needed minor alterations.

Reducing Caliper Brake Noise (Caliper Brake Only)

NOTE: The leading edge of the brake pads should make first contact with the rim when the adjustment is complete.

It is common for caliper brakes to make noise or “squeak” when in use. The noise may be reduced by following the instructions below:

- Make sure the caliper brakes are adjusted correctly
- Using a small adjustable wrench, bend each caliper arm so the front edge of each brake shoe is the first part to touch the rim

Brake pad replacement

Check your brake pads monthly for any indication of wear. If the pads are worn past the “wear line” indication the brake shoes need to be replaced. Always replace in pairs, never one side only.

Disconnect the holding mechanism specific to your brake type. Remove the worn brake pad shoes paying careful attention to the order and position in which the various curved washers and spacers attached. Fit the new brake pads, and tune the angle and the clearance to the rims as required. Normally before the rim clearance can be adjusted the control cable anchor bolt needs to be loosened and then the cable adjusters fasten and the cable tensioned. (Refer to previous steps).

Once adjustments are complete, securely fasten the brake pads in place and test that the brakes are functionally correctly.



WARNING: Don't ride bicycle until the brakes are working effectively.

Accessories

NOTE: Your bicycle may have one of the following accessories. Use the following instructions to install the accessory for your bicycle.

Make sure that you assemble each accessory so it does not interfere with the correct movement or operation of the steering or the brake lever(s) of the bicycle.

Rear Fender(if your bike has rear fender, please follow this step)

- Attach the rear fender bracket to the seat post. Ensure that the fender is facing backwards and that it is not touching the tyre as shown. Tighten all bolts. Place rear fender onto rear frame section, then secure with screw provided. Ensure the rear reflector is still clearly visible.



Chain

Inspection and Lubrication

Regular inspection and maintenance of your chain is vital to guard against premature wear. At least monthly, or after riding in wet, muddy or dusty conditions, the chain should be cleaned and lightly oiled. Any excess oil should be removed and care taken to ensure lubricant does not come in contact with tyres or rim braking surfaces. Check that all links of the chain move freely. Replace the chain if it appears stretched, broken or causes problems when changing gears.

Adjustment

The chain must be at the correct tightness. If too tight, the bicycle will be difficult to pedal. If too loose, the chain can come off the sprockets.



WARNING: The chain must remain on the sprockets. If the chain comes off the sprockets, the coaster brake will not operate.

When the chain (1) is at the correct tightness, you can pull it one-half inch (2) away from a straight edge (3) as shown.

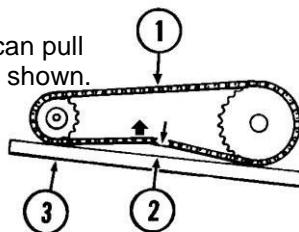

Adjust the tightness of the chain as follows:

- Loosen the axle nuts (4) of the rear wheel
- Loosen the clamp (5) on the brake arm (6), but do not remove the nut and the screw from the clamp

NOTE: Make sure the rear wheel is in the center of the

Bicycle frame.

- Move the rear wheel forward or backward as necessary, until you can pull the chain one-half inch away from a straight edge
- Hold the wheel in this position and tighten the axle nuts to the recommended torque of 24-29Nm.
- Tighten the brake arm clamp.

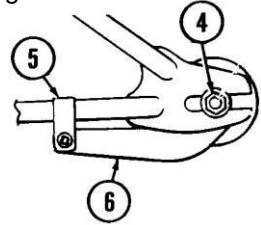

Bicycle Care and Maintenance

Routine bicycle maintenance is an essential component of riding. The condition of your bicycle changes every time it is used, meaning more frequent maintenance is necessary the more you ride your bicycle. The tables listed below outline the recommendations for servicing your bicycle. By referring to these and the information in other sections of this manual, you should be able to complete most of your bicycle maintenance yourself. Contact your specialist bicycle dealer if you require further assistance.

Lubrication

What	When	How
Brake Levers	every month	Put one drop of oil on the pivot point
Chain	every month	Put one drop of oil on each roller.
Caliper Brakes	every month	Put two drops of oil on the pivot point
Cantilever Brakes	every 6 months	Put two drops of oil on the pivot point
Brake and shift Cable	every 6 months	Put four drops of oil into both ends. Allow oil to soak back along the cable wire
Pedals	every 6 months	Put four drops of oil where the axles go into the pedals
Suspension	every 6months	Lift up the rubber fork boot and dab a Small amount of grease on the fork leg Just above the plastic bushing.

Wheel bearings Yearly lithium based grease

Headset Yearly lithium based grease

Seat pillar Yearly lithium based grease

Use a light machine oil to lubricate your bicycle.

Note:

-Increase the regularity of maintenance the more you ride and use in wet or dusty conditions.

-Take care not to over lubricate – excess lubricant should be removed to prohibit dirt build up.

-The chain can throw excess oil onto the wheel rims, wipe excess oil off chain.



WARNING:

Always seek expert advice for any maintenance requirements you feel unable to complete. You run the risk of potentially damaging your bicycle or yourself from falling if your bike is not correctly serviced or adjusted.

Service Checklist

Frequency

Task

Before every ride

Check tyre pressure
Check brake operation
Check wheels for loose spokes
Make sure nothing is loose

After every ride

Quick wipe down with damp cloth

Monthly

Lubrication as per schedule 1
Check derailleur adjustment
Check brake & gear cable adjustment
Check tyre wear and pressure
Check wheel are true and spokes tight
Check hub, head set and crank bearings for looseness
Check pedals are tight
Check handlebars are tight
Check seat and seat post are tight



WARNING:

All components of the bicycle are subjected to wear and stress through use. Watch closely for any scratches, cracks or discolouration on your bicycle components. These are signs of a stress-caused fatigue and indicate that a part needs to be replaced. Failure to replace can cause the component to suddenly fail when riding, which may result in serious injury or even death.

Recommended Torque

Nuts and bolts should be adjusted using a torque wrench. This helps to prevent over tightening and damage to the threads. Different torque measurements are recommended when tightening different components. Use the following table as a guide.

Component	Torque (N.m)
Front axle nuts	25-32
Rear axle nuts	24-29
Stem Bolt expander bolt	17-19
Handlebar clamp (single Bolt type)	21-25
Handlebar clamp (four bolt type-M6 bolt)	9-13
Handlebar clamp (four bolt type-M8 bolt)	18-20
Handlebar clamp (two bolt type-M7 bolt)	18-20
Stem adjustment cap(M6 bolt)	16-17
Seat Post clamp	15-19
Seat Post Quick Release	15-25
Saddle clamp	12-17
Pedals	24-30
Brake cable fixing nut	7-11

Brake caliper centre bolt/nut	6-8
Brake shoes	5-10
Cotterless crank nut	28-30

Tyres

Frequently check the tyre inflation pressures because all tyres lose air slowly over time. For extended storage, keep the weight of the bicycle off the tyres.

Inflation: Maintain tyre pressure at the level recommended on the tyre sidewalls.

Conversion from PSI to kilopascals is listed below.

PSI	Kilopascals
1	6.895
20	140
30	210
40	275
50	345
60	415

Maintenance

Frequently check the tyre inflation pressure because all tyres lose air slowly over time. For extended storage, keep the weight of the bicycle off the tyres.



WARNING: Do not ride or sit on the bicycle if either inner tube is under inflated. This can damage the tyre and inner tube. Do not use unregulated air hoses to inflate the inner tubes. An unregulated hose can suddenly over inflate bicycle tyres and cause them to burst.

Use a hand or a foot pump to inflate the inner tubes. Service station meter-regulated air hoses are also acceptable. The correct inflation pressure is shown on the tyre sidewall. If two inflation pressures are on the tyre sidewall, use the higher pressure for on-road riding and the lower

pressure for off-road riding. The lower pressure will provide better tyre traction and a more comfortable ride.

Before adding air to any tyre, make sure the edge of the tyre (the bead) is the same distance from the rim, all around the rim, on both sides of the tyre. If the tyre does not appear to be seated correctly, release air from the inner tube until you can push the bead of the tyre into the rim where necessary. Add air slowly and stop frequently to check the tyre seating and the pressure, until you reach the correct inflation pressure. Replace worn or defective tyres and inner tubes.

Fixing a Flat Tyre

1. Remove the wheel from the bicycle.
2. Deflate the tyre completely via the valve.
Loosen the tyre bead by pushing it inward all the way around.
3. Press one side of the tyre bead up over the edge of the rim.
- Use tyre levers, not a screwdriver, otherwise you may damage the rim.
4. Remove the tube, leaving the tyre on the rim.
5. Locate the leaks and patch using a tube repair kit, carefully following the instructions, or replace the tube.
Note: Ensure that the replacement tube size matches the size stated on the tyre sidewall and that the valve is the correct type for your bicycle
6. Match the position of the leak in the tube with the tyre to locate the possible cause and mark the location on the tyre.
7. Remove the tyre completely and inspect for a nail, glass, etc. and remove if located. Also inspect the inside of the rim to ensure there are no protruding spokes, rust or other potential causes. Replace the rim tape which covers the spoke ends, if damaged.
8. Remount one side of the tyre onto the rim.
9. Using a hand pump, inflate the tube just enough to give it some shape.
10. Place the valve stem through the hole in the rim and work the tube into the tyre. Note: Do not let it twist.
11. Using your hands only, remount the other side of the tyre by pushing the edge toward the center of the rim. Start on either side of the valve and work around the rim.
12. Before the tyre is completely mounted, push the valve up into the rim to make sure the tyre can sit squarely in position.
13. Fit the rest of the tyre, rolling the last, most difficult part on using your thumbs. Note: Avoid using tyre levers as these can easily puncture the tube or damage the tyre.
14. Check that the tube is not caught between the rim and the tyre bead at any point.

15. Using a hand pump, inflate the tube until the tyre begins to take shape, and check that the tyre bead is evenly seated all the way around the rim. When properly seated, fully inflate the tyre to the pressure marked on the sidewall.

16. Replace the wheel into the frame.

Inspection of the Bearings

Maintenance

Frequently check the bearings of the bicycle. Have a bicycle service shop lubricate the bearings once a year or any time they do not pass the following tests:

Head Tube Bearings

The fork should turn freely and smoothly at all times. With the front wheel off the ground, you should not be able to move the fork up, down, or side-to-side in the head tube.

Crank Bearings

The crank should turn freely and smoothly at all times and the front sprockets should not be loose on the crank. You should not be able to move the pedal end of the crank from side-to-side.

Wheel Bearings

Lift each end of the bicycle off the ground and slowly spin the raised wheel by hand. The bearings are correctly adjusted if:

- The wheel spins freely and easily
- The weight of the spoke reflector, when you put it toward the front or rear of the bicycle, causes the wheel to spin back and forth several times
- There is no side-to-side movement at the wheel rim when you push it to the side with light force.

Replacement Part Order List

To order warranty replacement parts, call us at (E.S.T) 1-800-632-792.

To order the correct part, refer to the model number stamped on the inside cover of this manual.

Hyper will make every attempt to find exact replacement parts for newly purchased bicycles. We cannot however, guarantee exact replacement parts or every part for older models.

Exploded Diagram

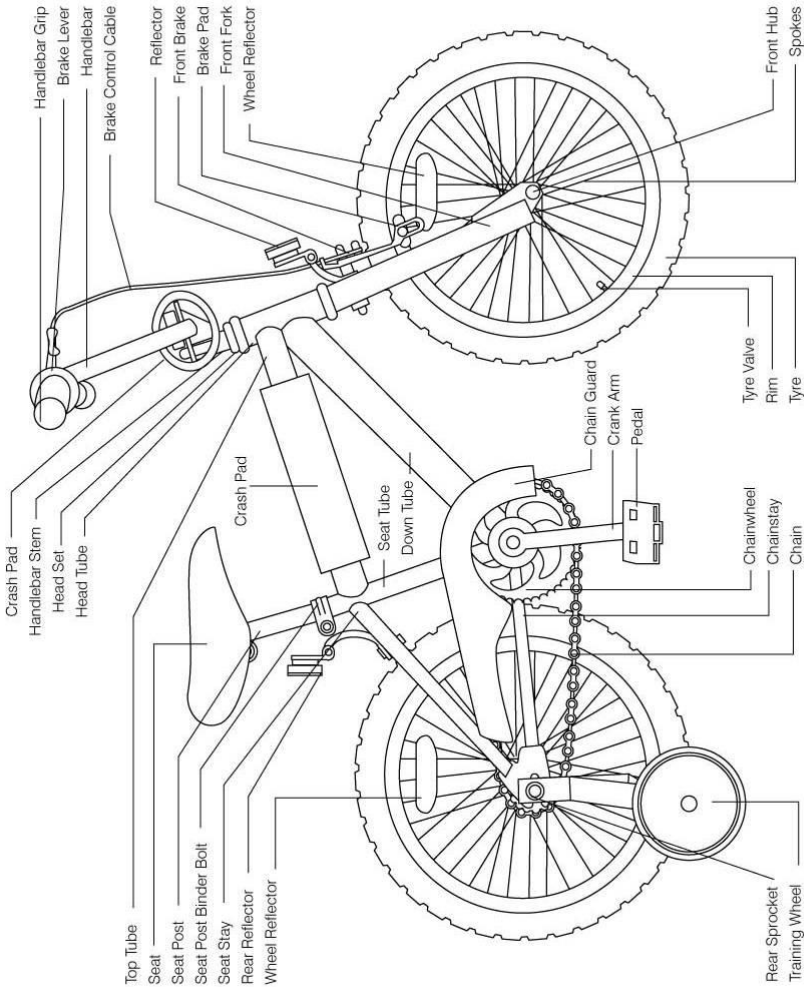

Warranty

Please **don't return this product to the store** if you need replacement parts or have a question regarding assembly of this product, please call our service center direct on 1800-632-792

Please retain your receipt as proof of purchase and contact our Customer Service Centre on 1800 632 792 (Australia) or 0800632792 (New Zealand) or alternatively, via email at spares@hunterleisure.com.au for any difficulties with your product.

Our goods come with guarantees that cannot be excluded under the Australian Consumer Law. You are entitled to a replacement or refund for a major failure and compensation for any other reasonably foreseeable loss or damage. You are also entitled to have the goods repaired or replaced if the goods fail to be of acceptable quality and the failure does not amount to a major failure.

For New Zealand customers, this warranty is in addition to statutory rights observed under New Zealand legislation