**TABLE OF CONTENTS**

|                      |    |
|----------------------|----|
| IMPORTANT SAFEGUARDS | 2  |
| BATTERY SAFETY       | 3  |
| PARTS                | 4  |
| PRODUCT OVERVIEW     | 4  |
| CONNECTING POWER     | 6  |
| HEADPHONES           | 6  |
| USING THE RADIO      | 6  |
| CD OPERATION         | 6  |
| AUX IN               | 8  |
| CARE AND MAINTENANCE | 8  |
| STORAGE              | 9  |
| TROUBLE SHOOTING     | 9  |
| TECHNICAL DATA       | 9  |
| WARRANTY             | 10 |

17090-CD318 IB P/N: 227-00318H14-01001 Size:  
105\*148mm 70g paper , 12 pages 6 sheets ,black printing  
(70g书纸 , 12版6页订装 , 黑色印刷 , 封面背面和封底空白 )

**42373117/42374336**

Please read these instructions carefully and keep for future reference.

Dear Customer,

Thank you for choosing the CD BOOMBOX. For correct operation and maintenance of this appliance, please read this User Manual carefully. Please pay particular attention to the Safety section.

## **IMPORTANT SAFEGUARDS**

Please read this instruction manual thoroughly before using this appliance! Follow all the safety instruction to avoid damage caused by improper use.

- Keep the instruction manual for future reference. Should this appliance be given to a third party, then this instruction manual must also be handed over.
- Use this appliance solely for its intended purpose.
- This appliance is intended for household use only.
- Only use this appliance indoors.
- The manufacture assumes no liability for possible damages that may have been caused by incorrect usage or mishandling of the appliance.
- This appliance is not intended for use by persons (including children) with reduced physical, sensory or mental capabilities, or lack of experience and knowledge, unless they have been given supervision or instruction concerning use of the appliance by a person responsible for their safety.
- Children should be supervised to ensure that they don't play with the appliance.



### **Danger of Electric Shock!**

- Before connecting the appliance to the mains supply, please check that the type of power and mains voltage match the information provided on the type plate.
- Always match wide blade of plug to wide slot, fully insert.
- Do not place any objects on the appliance. Don't put objects with naked flames (such as candles) on or next to the appliance. Never put items containing liquid (such as vases) on or next to the appliance.
- Keep the appliance away from all hot surfaces and naked flames. Always put the appliance on a level, stable, clean, dry surface. Protect the appliance from extreme heat and cold, dust, direct sunlight, humidity and drops or jets of water.
- If the supply cord is damaged, it must be replaced by the manufacturer, its service agent or similarly qualified persons in order to avoid hazard.
- Do not use the appliance if it is damaged, To avoid hazards, defective components must only be replaced by the manufacturer, his customer service or similar qualified persons.
- Do not open the housing under any circumstances. Do not introduce any objects into the interior of the housing.
- Do not immerse the appliance, power cord or power plug in water or in other liquids.
- Do not place the appliance in the direct vicinity of liquids- e.g. bathtubs and sinks, in a damp basement or close to a swimming pool.
- Do not start up the appliance with damp hands or if you are standing on a wet floor. Never grasp the power plug with damp or wet hands.

## **IMPORTANT SAFEGUARDS**

---

- Do not cover the ventilation openings of the appliance.
- Prevent damage to the power cord by not squeezing, bending or rubbing it on sharp edges. Keep the cord away from hot surfaces and open flames.
- Always pull the plug, not the power cord when disconnecting the appliance from a power outlet.
- Plug the appliance into an easily accessible socket, so that you can disconnect it quickly from the mains, in the event of an emergency. Unplug the appliance from the power socket to switch it off completely. Use the mains plug as a disconnecting appliance.
- Always switch the appliance to OFF before unplugging it.
- If the appliance malfunctions due to electrostatic discharge or short-term overvoltage, disconnect it from the power supply and connect it once again.
- Unplug the appliance during lightning storms or when unused for a long period of time.



**CAUTION! THIS PRODUCT UTILIZES A LASER. USE OF CONTROL OR ADJUSTMENTS OR PERFORMANCE OF PROCEDURES OTHER THAN THOSE SPECIFIED HEREIN MAY RESULT IN HAZARDOUS RADIATION EXPOSURE. DO NOT OPEN COVERS AND DO NOT REPAIR YOURSELF. REFER SERVICING TO QUALIFIED PERSONNEL.**

This appliance generates, uses, and can radiate radio frequency energy and, if not installed and used in accordance with the instructions, may cause interference to radio communications. If this appliance does cause interference to radio or television reception, which can be determined by turning the appliance off and on, the user is encouraged to try to correct the interference by one or more of the following measure:

- Reorient or relocate the receiving antenna.
- Increase the distance between appliance and receiver.
- Connect receiver and appliance to different outlets/circuits.

## **BATTERY SAFETY**

---

- Only use High quality batteries. Cheap batteries could leak and damage the device as a result.
- **Danger of explosion!** Batteries must not be charged or reactivated by other means, taken apart, thrown in the fire or short-circuited.
- Do not expose batteries to extreme temperatures such as from direct sunlight or fire. Do not place the appliance on a heater. Leaking battery acid can cause damage.
- **Caution!** There is a danger of explosion if the batteries are inserted incorrectly. Use only the same battery types with the corresponding technical data to replace them. Do not use old and new batteries or batteries of a different type or that are from different manufacturers together.
- Always insert batteries in accordance with the correct polarity(+ and -) as illustrated in the battery compartment.
- Batteries are life-threatening if swallowed. Store all batteries out of the reach of small children and domestic animals. Seek medical help immediately if batteries are swallowed.
- Do not allow children to change batteries without adult supervision.

## BATTERY SAFETY

---

- If the battery compartment door does not secure closely, stop using the appliance and keep it away from the children.
- If you think batteries might have been swallowed or placed inside any part of the body, Seek immediate medical attention.
- If the device is not to be used for an extended period of time, then the batteries should be removed, as the device could become damaged should they leak.
- If the device functions weaken, replace all batteries.
- Do not use old and new batteries or batteries of various types together.
- Remove the batteries prior to disposing of the device.
- **Batteries do not belong in household waste!** Expired batteries must be disposed of in an environmentally friendly way and according to the applicable legal regulations.

## PARTS

---

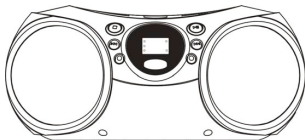

Power cord

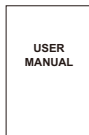

Portable CD Boombox with Stereo Radio

## PRODUCT OVERVIEW

---

- |                        |                                  |
|------------------------|----------------------------------|
| 1 REPEAT indicator     | 14 ■ STOP button                 |
| 2 POWER indicator      | 15 FM telescopic antenna         |
| 3 LED display          | 16 Carry handle                  |
| 4 FM ST. indicator     | 17 Band selector                 |
| 5 ►■ PLAY/PAUSE button | 18 Tuning control                |
| 6 ►  NEXT button       | 19 CD compartment                |
| 7 RANDOM button        | 20 CD door open push spot        |
| 8 Speaker              | 21 Battery compartment (covered) |
| 9 PLAY/PAUSE indicator | 22 VOLUME control                |
| 10 REPEAT button       | 23 FUNCTION switch               |
| 11 PROG. indicator     | 24 AC input                      |
| 12 PROGRAM button      | 25 AUX IN jack                   |
| 13 ◀◀ BACK button      | 26 PHONES jack                   |

# PRODUCT OVERVIEW

---

FRONT

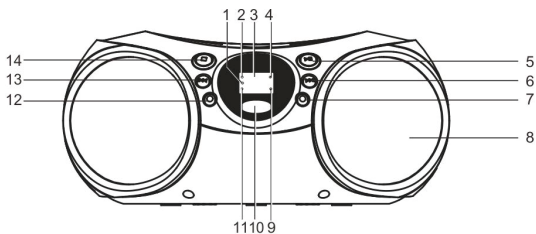

TOP

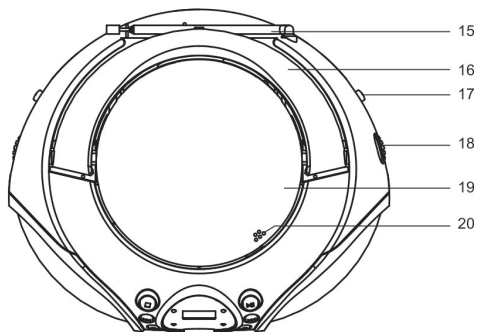

LEFT SIDE

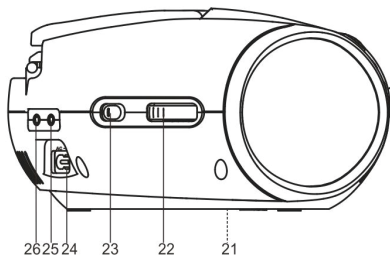

## **CONNECTING POWER**

---

### **AC Power**

Use **ONLY** the power cord supplied with this device.

1. Insert the power cord into the AC input (24) and plug the other end of the cable into a wall outlet.
2. To turn the device on, slide the FUNCTION switch (23) to CD/AUX or RADIO. The POWER indicator (2) lights up.

### **Battery Power**

To use your CD Boombox as a portable device you need to install 6 "C" size batteries.

1. To open the battery compartment (21), turn the CD Boombox over.
2. Press both tabs simultaneously and lift the cover off.
3. Insert 6 C Size batteries (not included) according to the polarity indicated in the battery compartment.
4. Replace the battery compartment cover.
5. Remove the batteries if they are flat or you do not use the device for a longer period of time.

## **HEADPHONES**

---

1. For private listening, plug your headphones/earphones (not included) into the 3.5mm PHONES jack (26).

**CAUTION:** Long time listening with headphones/earphones at high volumes may cause harmful damage to users' ears.

## **USING THE RADIO**

---

1. Move the FUNCTION switch (23) to RADIO position. The POWER indicator (2) lights up.
2. Slide the BAND selector (17) to the desired wave band: AM or FM ST..
3. Tune to required station by rotating the TUNING control (18).
4. Rotate the VOLUME control (22) to a comfortable volume level.
5. Extend the telescopic FM antenna (15) to its full length if you are listening to FM ST. broadcasting. When you received the program signal, the FM ST. indicator (4) will light up. Adjust the position of the device to get the best reception when you are listening to AM program.
6. Turn off the radio by switching the FUNCTION switch to "OFF" position

## **CD OPERATION**

---

If a disc does not conform to the standard, it may not play properly.

**Attention:** Before first use, you must remove the protective cover from the lens area.

### **LOAD A DISC**

1. With the carry handle (16) folded down, press the CD door open push spot (20) to automatically lift the CD door.
2. Place a disc into the disc compartment (19) with the label facing up.

## CD OPERATION

---

3. Press the lid down to close the disc compartment.
4. Slide the FUNCTION switch (23) to CD/AUX. The Power indicator (2) lights up and the LED display (3) shows the total number of tracks.

### PLAY A DISC

1. Press the PLAY/PAUSE button ►■ (5) to start playback. The PLAY/PAUSE indicator (9) lights up and the first track begins to play.

### PAUSE PLAYBACK

1. To pause press the PLAY/PAUSE button ►■ (5). The playback stops and the PLAY/PAUSE indicator light (3) blinks.
2. To resume play, press the PLAY/PAUSE button ►■ again.

### STOP PLAYBACK

1. Press the STOP button ■ (14). The playback stops and the disc goes back to the beginning.

### BACK AND NEXT

1. Press the BACK button ◀◀ (13) to go back to the start of the previous song.
2. Press the NEXT button ▶▶ (6) to jump to the start of the next song.

### REPEAT

1. During playback, press the REPEAT button (10) once. The REPEAT indicator (1) blinks and the current song will be repeated.
2. To repeat all songs, press the REPEAT button twice. The REPEAT indicator lights up.
3. To cancel the repeat function. Press the REPEAT button until the REPEAT indicator light is off.

### RANDOM PLAY

1. Press the RANDOM button (7) in Play/Stop mode. The current track and "-" will light up and move around the LED display. Playback will start from any one track (not in the order of the disc).
2. To cancel random play, press the RANDOM button again.

### PROGRAM

Use this function to program the playback of songs in a preselected order.

1. In STOP mode, press the PROGRAM button (12). The PROG indicator (11) flashes and the LED display (3) shows 01.
2. Press the BACK button ◀◀ (13) or NEXT button ◀◀ (6) button to select the desired track.
3. Press the PROG button to confirm the song choice.
4. The LED display shows 02.
5. Repeat the above steps to a maximum of 20 tracks.
6. Press the PLAY/PAUSE button ►■ (5) to play the program list. The PROG indicator lights up.
7. To clear a program list, press the STOP button ■ (14) twice. The PROG indicator switches off.

## AUX-IN

---

You can connect an external music player or sound source to your CD Boombox.

1. Plug a 3.5mm audio cable (not included) into the AUX-IN jack (25) and connect the other end to your external audio source. The unit will change to AUX mode automatically.
2. Press PLAY of the external audio source (eg. MP3 player) to start playback.
3. The volume can be adjusted with your audio source as well as the VOLUME control (22).

## CARE AND MAINTENANCE

---

**Danger of electroshock!** Do not immerse the appliance, power cord or power plug in water or in other liquids.

- ▶ Wipe all parts with a dry soft cloth.

### Disc Care

Treat discs carefully. Always hold a disc by its edges and the hole in the center. Never allow your fingers to come in contact with the shiny, unprinted side of a disc as this could lead to issues with the playback.

- ▶ Clean discs periodically with a soft, lint-free, dry cloth.

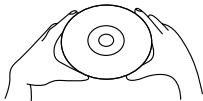

- ▶ Never use detergents or abrasive cleaners to clean discs. If necessary, use a CD cleaning kit.
- ▶ When cleaning a disc, wipe in straight lines from the center of the disc to the outer edge. Never wipe in circular motions.



- ▶ Discs should be stored in their cases after each use to avoid damage.



- ▶ Do not stick or write anything on either side of the disc. Sharp writing instruments or ink may damage the surface.
- ▶ Do not expose discs to direct sunlight, high temperatures or dust etc. Prolonged exposure or extreme temperatures can warp the disc.



## STORAGE

---

- ▶ If you are not going to use your device for some time, disconnect it from power and remove the batteries from the battery compartment.
- ▶ Store the device in a cool dry place away from direct sunlight.

## TROUBLE SHOOTING

---

| Problem  | Solution   |
|--|--|
| No power.  | <ul style="list-style-type: none"><li>▶ Ensure that the power plug is connected to an AC outlet.</li><li>▶ Ensure that the cable is properly plugged into the device.</li><li>▶ The AC outlet may not have power. Check the outlet with a working lamp or other electrical appliance.</li><li>▶ The batteries might be flat. Change batteries.</li></ul>   |
| No sound.  | <ul style="list-style-type: none"><li>▶ Volume control might be set to minimum. Turn up the volume.</li><li>▶ Your external player might not be plugged in properly. Check the AUX In connection.</li></ul>  |
| CD Boombox does not work normally or the LED displays: "--", "E" or "no" | <ul style="list-style-type: none"><li>▶ There might be a problem with the CD: Ensure that it is a standard CD, inserted correctly, clean and free of scratches.</li><li>▶ It is possible, that moisture has formed inside the CD deck. Wait about 20 to 30 minutes to let it dry out.</li><li>▶ It is possible, that the device needs to be reset. Disconnect from the power source for approx. 30 seconds and then reconnect.</li></ul> |

## TECHNICAL DATA

---

|                          |   |
|--------------------------|---|
| Power Source:            | AC 240V ~ 50Hz<br>or DC 9V  , 6 x C size, 1.5V batteries |
| Power Consumption:       | 13W   |
| Power Output:            | 1.2W x 2 (RMS)  |
| Operating Temperature:   | + 5°C to + 40°C   |
| Compatible Disc Formats: | CD, CD-R, CD-RW   |
| Receiving Band:          | AM/FM.ST  |
| Tuning Range:            | AM: 522 - 1620 KHz<br>FM: 87.5 - 108 MHz  |
| Antenna:                 | FM rod antenna, AM built-in ferrite bar   |

## 12 Month Warranty

Thank you for your purchase from Kmart.

Kmart Australia Ltd warrants your new product to be free from defects in materials and workmanship for the period stated above, from the date of purchase, provided that the product is used in accordance with accompanying recommendations or instructions where provided. This warranty is in addition to your rights under the Australian Consumer Law.

Kmart will provide you with your choice of a refund, repair or exchange (where possible) for this product if it becomes defective within the warranty period. Kmart will bear the reasonable expense of claiming the warranty. This warranty will no longer apply where the defect is a result of alteration, accident, misuse, abuse or neglect.

Please retain your receipt as proof of purchase and contact our Customer Service Centre on 1800 124 125 (Australia) or 0800 945 995 (New Zealand) or alternatively, via Customer Help at [Kmart.com.au](http://Kmart.com.au) for any difficulties with your product. Warranty claims and claims for expense incurred in returning this product can be addressed to our Customer Service Centre at 690 Springvale Rd, Mulgrave Vic 3170.

Our goods come with guarantees that cannot be excluded under the Australian Consumer Law. You are entitled to a replacement or refund for a major failure and compensation for any other reasonably foreseeable loss or damage. You are also entitled to have the goods repaired or replaced if the goods fail to be of acceptable quality and the failure does not amount to a major failure.

For New Zealand customers, this warranty is in addition to statutory rights observed under New Zealand legislation.