

# 14FT (427CM) TRAMPOLINE AND "STEELFLEX PRO" ENCLOSURE COMBO SET

Assembly, Installation, Care, Maintenance, and Use Instructions

**MODEL NUMBER # TR-14C-PLX-01**

**KEYCODE: 41790038**

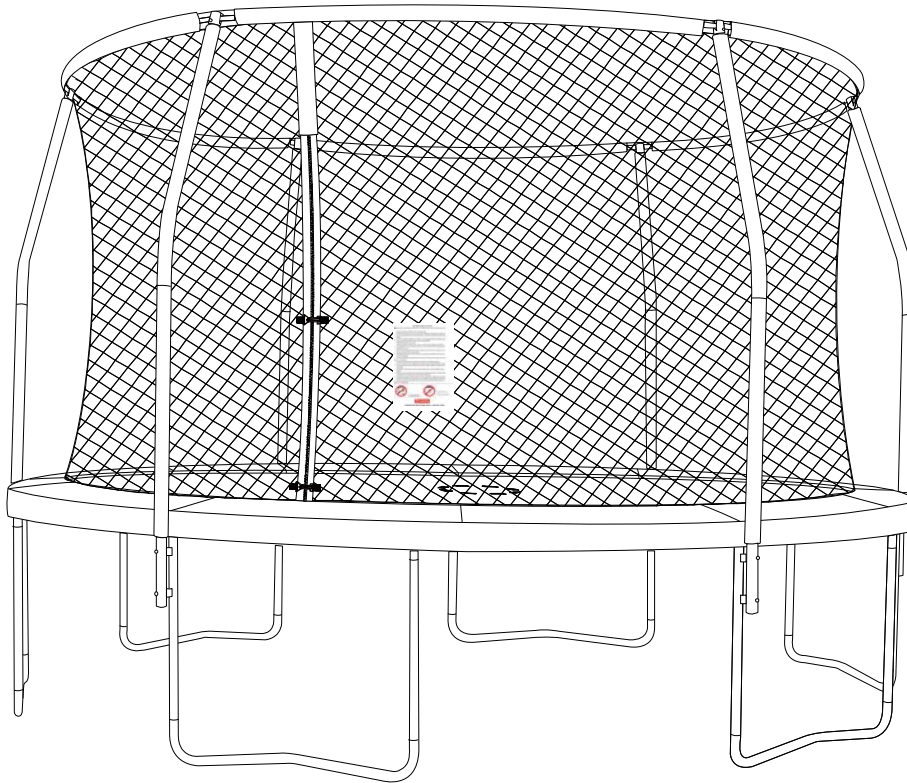

## **⚠ DANGER**

- DO NOT attempt somersaults or flips. Paralysis or death can result if you land on your head or neck!
- No more than one person on the trampoline at a time. Multiple users increase the risk of injury.
- Use trampoline only with mature, knowledgeable supervision.

## **⚠ WARNING**

- These instructions are important to minimize chances of injury. Please read each of them thoroughly before you assemble and use this trampoline. Retain this manual for future reference.
- Maximum weight of the user shall NOT exceed 220lbs/100kg for this product.

CUSTOMER SERVICE

Toll Free: 1-800-333-061

MONDAY-FRIDAY, 9 A.M. - 5 P.M. CENTRAL TIME

# DANGER



**NO SOMERSAULTS OR FLIPS – PARALYSIS OR DEATH** can result if you land on your head or neck!



No more than **ONE** user at a time (maximum weight - 220 lbs/100 kg).



Do not use if in a cast or have previous leg, arm, head, neck or back injury.



Do not allow children less than six (6) years of age to use.



Remove all hard or sharp objects including jewelry, eyeglasses, sunglasses or hairclips before jumping.



Do not use without the consent of your physician, if pregnant.

## Daily Pre-Inspection:

- >Inspect legs for proper attachment or cracks
- >Inspect netting for tears and sagging
- >Inspect for loose or damaged trampoline mat
- >Inspect mat for tears or worn stitching
- >Inspect frame for sagging or cracks

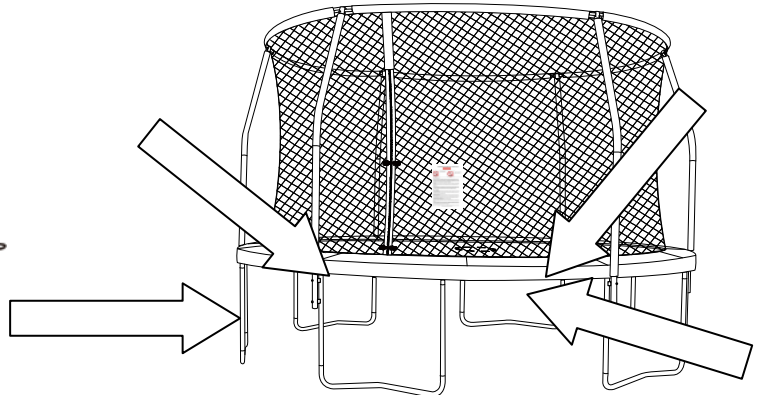

**Inspect prior to use** – check that the legs are properly attached and stable on the ground; no loose springs; mat and enclosure net are in proper place and in good condition with no tears.

## INTRODUCTION

---

Congratulations on your trampoline purchase! This trampoline was designed and manufactured with quality materials and craftsmanship, providing fun and exercise in the enjoyment of your own backyard.

It is very important that the owners and users of this trampoline have adequate knowledge of techniques and rules for proper use. In particular, children must be supervised at all times by a knowledgeable and mature adult while using the trampoline. Take precautions to prevent access to the trampoline by children when there is no adult supervision. Also restrict access to any unauthorized users without your consent.

Carefully read and understand all of the instructions and warnings in the User Manual before assembling and using this product. It is the responsibility of the owner of this trampoline to ensure that all users of this product are fully informed on the proper use and the inherent risks of jumping on a trampoline. Failure to do so can result in serious injury or death. In particular, under no circumstances should you attempt or allow flips, somersaults or any similar conduct. Landing on the head or neck can cause serious injury, paralysis, or death, even when landing in the middle of the mat. Also, do not allow more than one person on the trampoline under any circumstances. Use by more than one person at the same time increases the chance of injury.

To reduce risks associated with users falling off the trampoline, enclosure netting must be properly installed and used at all times. The trampoline enclosure must be closed during use to prevent the user from falling off the trampoline. Your trampoline enclosure netting is manufactured with UV resistant material. Despite this, exposure to harsh elements (sunlight, wind, moisture, animals, etc) will weaken the netting. The netting and mat must be inspected prior to every use and maintained regularly as detailed in this User's Manual.

Please also ensure proper placement of this product to avoid injuries. It is essential that the intended site for this trampoline is completely flat and level. If the ground is uneven, this could cause movement in the frame and stress on the joined sections of the frame that could damage the trampoline and/or can cause serious injury. Do not position this trampoline on hard surface such as concrete, tarmac or paving. Suitable surfaces include flat dirt or grass, sand or play area covered with an appropriate depth of play bark material, with no obstructions above, below or near the product.

The product must not be used in windy conditions as wind can cause unexpected movement of the product. Wind can cause the trampoline to be lifted off the ground and become airborne. This can present a danger to individuals and to property. Winds can be especially strong in open areas, foothills, mountains, locations subject to hurricanes and tornadoes, areas between homes that create wind tunnels and anywhere else where local weather conditions can create high winds. We recommend that you anchor the trampoline or otherwise secure the trampoline to prevent it from moving as a result of the wind. One possible way to anchor the trampoline is to secure the trampoline to a concrete footing under each leg. We recommend consulting a local licensed contractor to best determine how the anchor system should be constructed for your specific conditions. The licensed contractor can also advise you of other options such as below ground installation. Even with anchors, a trampoline can be lifted, just like anything else, by strong winds. If the winds are anticipated to be very strong, the trampoline should be disassembled and stored away safely until the weather conditions improve. Damage from the wind or other severe weather is not covered by the manufacturer's warranty. Because the manufacturer warranty does not cover wind or weather related damage and damage can be caused to your property or the property of others by a windblown trampoline, it is strongly advised that you provide site specific anchoring through a licensed local contractor.

Only genuine replacement parts sold through our authorized dealer are recommended. Replacement parts from other sources may not have been designed, tested or manufactured to meet our testing standards. Because of this, we cannot guarantee the performance and safety of the product when non genuine replacement parts are used. The use of non-genuine authorized replacement parts may affect any warranty claim on the product, as allowed by the law in your jurisdiction.

**We warrant our products against defects in material and workmanship. DO NOT RETURN PRODUCT TO THE STORE. FOR CUSTOMER SERVICE OR REPLACEMENT PARTS, PLEASE CALL 1-800-333-061.**



- Use trampoline only with mature, knowledgeable adult supervision.
  - Do not attempt or allow somersaults. Landing on the head or neck can cause serious injury, paralysis, or death, even when landing in the middle of the mat.
  - Do not allow more than one person on the trampoline. Use by more than one person at the same time increases the chance of injury.
- 

Before you start to assemble.....	1
Before using the product.....	1
Important Warnings.....	2
Important Instructions for Enclosure Netting and Mat.....	6
Trampoline and Enclosure Parts List.....	8
Hardware Parts List.....	9
Assembly and Installation Instructions.....	10
Trampoline Frame Assembly.....	11
Trampoline Mat Assembly.....	15
Frame Pad Assembly.....	20
Trampoline Enclosure Assembly.....	21
Disassembly of the Trampoline and Enclosure.....	29
Moving the Trampoline and Enclosure.....	29
Care and Maintenance.....	30
Proper Use Instructions.....	31
Learning the fundamental trampoline skills.....	33
Product Warranty.....	35

## DANGER

- Use trampoline only with mature, knowledgeable adult supervision.
  - Do not attempt or allow somersaults. Landing on the head or neck can cause serious injury, paralysis, or death, even when landing in the middle of the mat.
  - Do not allow more than one person on the trampoline. Use by more than one person at the same time increases the chance of injury.
- 

## WARNING

**Carefully read and understand all of the instructions and warnings in this manual before assembling and using this product. It is the responsibility of the owner of this trampoline to ensure that all users of this product are fully informed on the proper use and the inherent risks of jumping on a trampoline. Failure to do so can result in serious injury or death.**

### **Before you start to assemble...**

- Check the package and make sure you have all of the parts listed in the Parts List section of this user manual. IF ANY PARTS ARE MISSING, please call the Customer Service toll-free number listed on the cover page for assistance.
- Do not install or use the product if any parts are missing or damaged. Store in a safe place until ready to install.
- Make sure that you have plenty of space and a clean dry area suitable for the assembly of this trampoline. **IT IS ESSENTIAL THAT THE INTENDED SITE FOR THIS TRAMPOLINE IS COMPLETELY FLAT AND LEVEL.** If the ground is uneven, this could cause movement in the frame and stress on the joined sections of the frame that could damage the trampoline and/or can cause serious injury.
- Two adults are needed to assemble this trampoline.
- Heavy gloves must be used to protect your hands from pinch points during assembly and goggles must be worn to avoid injuries to the eyes.
- Never modify the construction or the design of the product. Do not use any unauthorized manufacturer replacement parts.
- This pack may contain small parts and is not suitable for children under six (6) years of age to be nearby during assembly.
- **IMPORTANT:** Save this manual for future reference.

### **Before using the product...**

- Use of this trampoline requires constant adult supervision. Use the trampoline only with mature and knowledgeable **ADULT** supervision.
- Ensure that the trampoline enclosure has been assembled correctly, as per the instructions in this manual and that the zip and attachment system are fully attached before use.
- Trampolines over 20 in. (51 cm) tall are not recommended for use by children under 6 years of age.
- There must be no more than one person at a time on the trampoline.
- Maximum weight of the user shall NOT exceed 220lbs/100kg for this product.
- This product is for household and family domestic use only – It is not for use in schools, playgrounds, rental or commercial use.

**! DANGER**

- Use trampoline only with mature, knowledgeable adult supervision.
  - Do not attempt or allow somersaults. Landing on the head or neck can cause serious injury, paralysis, or death, even when landing in the middle of the mat.
  - Do not allow more than one person on the trampoline. Use by more than one person at the same time increases the chance of injury.
- 

**Important Warnings**



**Carefully read these warnings before using this product. Failure to follow these warnings can result in serious injury or death.**

**! DANGER**

- Only one user at any one time! Multiple users can cause loss of control, collision or falls on the trampoline. This could result in serious injury to legs, arms, back, neck or head.
- Do not use the trampoline when under the influence of alcohol, drugs or medication, which may impair the jumper's judgement.
- Always consult your physician before performing any kind of physical activity.
- Do not use the trampoline if you have high blood pressure.
- Do not use the trampoline if you have a medical history of neck or back injuries or mental or physical conditions that could cause injury.
- Do not use if the user has any broken bones (casts) or has recently been in the hospital for extensive treatments (operations, severe wounds, stitches, back injury or concussion).
- Do not use without the consent of your physician, if pregnant.
- Do not use the trampoline during windy conditions or if the user or the trampoline surface is wet. These conditions can cause the user to lose control and fall resulting in serious injury.

**! DANGER**

- Use trampoline only with mature, knowledgeable adult supervision.
  - Do not attempt or allow somersaults. Landing on the head or neck can cause serious injury, paralysis, or death, even when landing in the middle of the mat.
  - Do not allow more than one person on the trampoline. Use by more than one person at the same time increases the chance of injury.
- 



**Carefully read these warnings before using this product. Failure to follow these safety instructions can result in serious injury or death.**

**! WARNING****Proper Play Conditions:**

- Always use the product in a well-lit area. Do not use without lighting during dawn, dusk or in complete darkness!
- The trampoline must be placed on a surface that is **COMPLETELY FLAT AND LEVEL**. If the ground is uneven, this could cause movement in the frame and could cause stress on the joined sections of the frame that could damage the trampoline and/or can cause serious injury.
- **DO NOT** install or position this trampoline on a hard surface such as concrete, tarmac or paving. Suitable surfaces are grass, sand or a play area covered with an appropriate depth of play bark material.
- Maintain a free space of minimum 2.5 metres on all sides of the product. Make sure that there are no hazardous objects above, below or near the trampoline. Such objects include walls, concrete, bitumen, brick, fences, tree limbs/trunks, electrical power wiring, rocks, sprinkler heads or other recreational objects (i.e. swing sets, swimming pools) or other hard surfaces as these can cause serious injuries". Children can be seriously injured by colliding with such obstacles.
- Adequate overhead clearance is essential. A minimum of 26.25 ft (8 metres) from ground level is recommended. Provide clearance for wires, tree limbs, and other possible hazards.
- Do not use the trampoline indoors, as this product is intended for outdoor home use only.
- The product must not be used in windy conditions as wind can cause unexpected movement of the product. Wind can cause the trampoline to be lifted off the ground and become airborne. This can present a danger to individuals and to property. Winds can be especially strong in open areas, foothills, mountains, locations subject to hurricanes and tornadoes, areas between homes that create wind tunnels and anywhere else where local weather conditions can create high winds. We recommend that you anchor the trampoline or otherwise secure the trampoline to prevent it from moving as a result of the wind. One possible way to anchor the trampoline is to secure the trampoline to a concrete footing under each leg. We recommend consulting a local licensed contractor to best determine how the anchor system should be constructed for your specific conditions. The licensed contractor can also advise you of other options such as below ground installation. Even with anchors, a trampoline can be lifted, just like anything else, by strong winds. If the winds are anticipated to be very strong, the trampoline should be disassembled and stored away safely until the weather conditions improve. Damage from the wind or other severe weather is not covered by the manufacturer's warranty.

**! DANGER**

- Use trampoline only with mature, knowledgeable adult supervision.
  - Do not attempt or allow somersaults. Landing on the head or neck can cause serious injury, paralysis, or death, even when landing in the middle of the mat.
  - Do not allow more than one person on the trampoline. Use by more than one person at the same time increases the chance of injury.
- 



**Carefully read these warnings before using this product. Failure to follow these safety instructions can result in serious injury or death.**

**! WARNING****Appropriate Use Conditions:**

- Children must always be supervised while they are playing on the trampoline and must be instructed not to use the trampoline in an inappropriate or hazardous manner. Take precautions to prevent access to the trampoline by children when there is no adult supervision.
- Restrict access to the trampoline by any unauthorized users without your consent.
- Trampolines are rebounding devices, which propel the user to unaccustomed heights, and into a variety of body movements. Rebounding off of the trampoline, striking the frame or hooks, or improperly landing on the trampoline mat may cause serious injury.
- Always start and maintain your jump at the center of the trampoline mat in order to reduce the risk of landing on the frame or hooks or falling off the trampoline.
- Avoid bouncing too high. Stay low until you can control your bounce and land consistently in the middle of the trampoline mat.
- Ensure the trampoline frame and springs are fully covered by the frame pad to avoid any direct contact with metal parts.
- Do not stand or jump on the hooks while using the trampoline. The hooks are not designed to support such stress and weight. This can result in serious injuries and/or product damage. If you see any signs of stretched or damaged straps or hooks, do not use the trampoline until replacement are properly installed. Please contact our customer service representatives to order original manufacturer replacement parts.
- The trampoline is several feet off the ground. Jumping off the trampoline to the ground or any other surface may result in injury. Smaller children may need assistance getting up onto or down from the trampoline. Mounting and dismounting properly should be followed as a strict rule. Users should climb onto the trampoline by placing their hands on the frame and stepping or rolling up onto the frame, across the hooks and onto the mat. Do not step directly on the frame pad or grasp the frame pad when mounting or dismounting the trampoline. To dismount, jumpers should walk to the side of the mat, bend over and place their hands on the frame, then step from the mat to the ground. Users should always place their hands on the frame while mounting or dismounting.
- Do NOT use the trampoline as a springboard to jump onto other objects.
- Remove all objects not designed for use with the trampoline from the trampoline before use. Do not let children take toys or other items onto the trampoline.



**! DANGER**

- Use trampoline only with mature, knowledgeable adult supervision.
  - Do not attempt or allow somersaults. Landing on the head or neck can cause serious injury, paralysis, or death, even when landing in the middle of the mat.
  - Do not allow more than one person on the trampoline. Use by more than one person at the same time increases the chance of injury.
- 



**Carefully read these warnings before using this product. Failure to follow these safety instructions can result in serious injury or death.**

**! WARNING**

- Do not jump or step onto the frame pad as it was not designed to support the weight of a person.
- Do not use the trampoline while holding or wearing any type of sharp or pointed objects such as jewelry, watches, rings, eyewear and necklaces before using this product. This will prevent the jewelry from tearing the mat or getting caught in the enclosure netting.
- Do not wear loose fitting clothing that may catch or snag during play.
- Never wear footwear (e.g. shoes) when using the trampoline.
- Always tie back long hair so that it does not block user's vision or get caught in the enclosure netting.
- FRAME PADS – Frame pads are there to protect user from any fall or landing on the hooks and frame. On no account should people be permitted to sit or stand on them when the trampoline is in use. You should also make sure that smaller users do not use the inside edges of the pads as a “handle” when getting up on to the trampoline.
- Never use the trampoline without the frame pad being securely attached. Properly tie down the frame pad before each use. Improper assembly of the frame pad may lead to injury!
- Always check to ensure there are no obstructions or objects under the trampoline that could cause injury or obstruct movement of jump mat. Also check that there are no pets or other people underneath the trampoline.
- Do not jump on the trampoline with a snowboard, skateboard, roller blades, bicycle or any other equipment. DO NOT hold any foreign objects not authorized by the manufacturer in your hand and DO NOT place any objects on the trampoline while anyone is jumping on it. Please be aware of your surroundings to ensure there are no objects that could cause harm when you are playing on the trampoline.
- The frame of your trampoline is made of steel and it will conduct electricity. No electrical equipment (lights, heaters, extension cords, household appliances, etc.) should be permitted in or on the enclosure under any circumstances to avoid the risk of electrocution.

**Enclosure Netting and Mat – Appropriate Use Conditions**

- Children MUST NEVER be left unattended inside the enclosure at any time.
- The enclosure is ONLY intended to be used to reduce the risk of injury from falling off the trampoline. Do not intentionally kick, bounce against, climb on, hang from, jump over or crawl under the netting.
- Enter and exit the enclosure only through the zipper door. Do not go through the gap between the netting and the mat. Trying to exit this way poses a risk of strangulation, especially for young children.
- The enclosure netting and mat must be inspected prior to each use. If there are any signs of weakness, you must stop using the trampoline immediately, properly store the trampoline and restrict access by users until authorized replacement netting or pad is installed. Please refer to the Trampoline Net & Pad – Maintenance Requirements section contained in this manual for further details.

**Important Instructions for Enclosure Netting and Mat**



**Failure to follow these instructions to ensure proper operational condition of your trampoline may lead to serious injury or death.**

**1. Maintenance of Trampoline Enclosure Net, Mat and Pad**

Enclosure nets and padding are prone to wear and tear like tires on a car. Gradual deterioration of the material will occur; the speed of which will depend on the level of exposure to UV rays, airborne pollution and outdoor weather conditions such as rain and wind.

The net and padding needs to be properly maintained and checked by following the Maintenance Schedule set out in these instructions. When the material shows any signs of weakness, you must stop using the trampoline immediately, properly store the trampoline and restrict access by users until a new replacement net or padding is properly installed.

Official replacement nets and padding can be purchased by contacting our authorized customer service by toll free number.

**2. Maintenance Requirement for Enclosure Net**

Your trampoline enclosure netting is manufactured with UV resistant material. Despite this the netting is exposed to the outdoor elements including sunlight, wind, rain and wildlife. The net surrounding the trampoline must be checked prior to each use. This includes, but is not limited to inspecting the net for cracks, excess wear, brittleness, and stretching. Also inspect all connections and the entire enclosure for overall integrity. The net must be immediately replaced if it shows any signs of wear, damage, stretching, cracking, looseness, brittleness or other losses in integrity. The following Maintenance Schedule must be followed:

<b>1 to 3 Months</b>	<b>3 to 6 Months</b>	<b>6 to 12 Months</b>
Inspect the enclosure (net, net hanger, and straps) prior to every use.	Thorough inspection for UV damage and prior to every use for net, net hanger and straps.	Thorough inspection before every use on net, net hanger, straps, zippers, ties and strings. Replace after 12 months or earlier if necessary.

**IT IS RECOMMENDED THAT THE NET BE REPLACED ON A YEARLY BASIS UNDER NORMAL USE, EVEN IF IT DOES NOT SHOW ANY VISIBLE SIGNS OF DAMAGE.**

### How to Inspect the Trampoline Net for Proper Use

Always check the enclosure netting for signs of UV damage, deterioration, brittleness, cracking, and tearing every time before using the trampoline and enclosure.

Step 1 - Inspect the enclosure netting before **EACH** use for wear or tear by pinching and pulling a section of the netting between fingers and pulling downward. Please see diagram below.

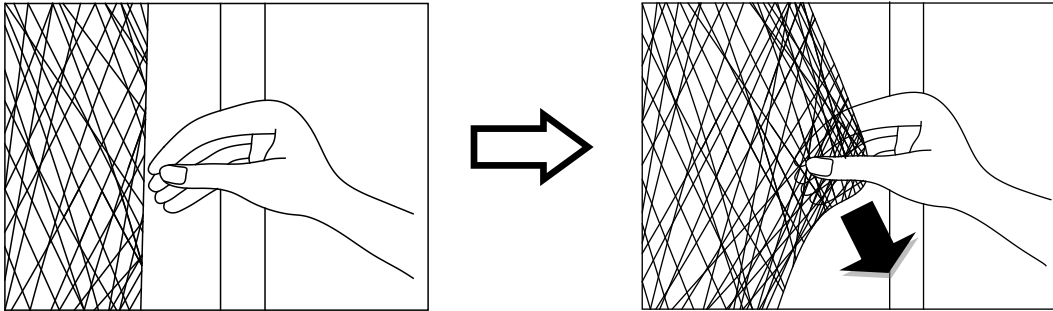

If it produces any tear or cracking or ripping sound, then the net is unsafe and **MUST** be taken down immediately. **STOP USING THE TRAMPOLINE ENCLOSURE IF YOU FIND ANY SIGNS OF WEAR OR TEARING ON THE NETTING.**

Step 2 - Walk around the whole perimeter of the trampoline to visually check for material deterioration or other damage.







### 3. Maintenance Requirement for Trampoline Pad

Walk around the whole perimeter of the trampoline to visually check for material deterioration, tears, looseness, loss of elasticity or other damage in the pad.

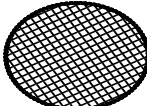
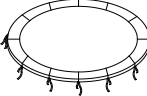

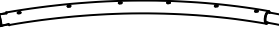
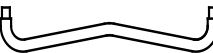
**It is recommended that you replace the trampoline enclosure net and pad every 12 months. Replace the enclosure net and pad earlier if there are any signs of wear, tear, brittleness, cracking, stretching or any other signs of weakness. New enclosure netting and pad can be purchased through our authorized service center.**

## Trampoline and Enclosure Parts List

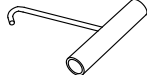





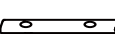
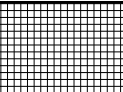







### Trampoline

Key Number	Part Number	Part Picture	Description	Quantity
1	TM-14-72-28		Trampoline Mat, stitched with Triangle-Rings	1
2	TFP-14-28-PE		Frame Pad	1
3	TRLS-14-72-42		Top Rail with Leg Sockets	6
4	TR-14-72-42		Top Rail	6
5	TLB-14-38.1		Leg Base	6
6A	TVL-14-38.1		Vertical Leg Extension	6
6B	TVLH-14-38.1		Vertical Leg Extension (two holes)	6
7	T28N		Spring	72
8	TSP-14		Trampoline Safety Instruction Placard	1
9	TSLT		Spring Loading Tool	1

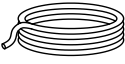
### Enclosure

Key Number	Part Number	Part Picture	Description	Quantity
A2	EUT-14-6P-31.8-R3		New Upper Frame Tube with Foam	6
B	ELT-14-6P-31.8		Lower Frame Tube with Foam	6
C1	ECW-14-6P-N3		Flat Steel	12
C2	EFSS-14		Flat Steel Sockets	12
M	EN-14-6P		Enclosure Netting	1

**Hardware Parts List**

Key Number	Part Number	Part Picture	Description	Quantity
D	W		Wrench	1
E	EGS2W-14-38.1		Gap Spacer	12
F	ES-14-38.1		Bolt	12
G	ESLW-14		Spring Lock Washer	12
H	ECN-14		Cap Nut	12
I	ESLS-14		Self-Locking Screw	18
J	EAW-14		Arc Washer	12
K	AW		Allen Wrench	1
L	EC-14		Cord	8
O	EEC-14-31.8		End Cap	6
P	EPC-31.8-P1		Bolt (12mm)	24
Q	EPC-31.8-P2		Cap Nut	24
R	EPC-N3		Plastic cap	6
10	ESLW-14-S		Small Spring Lock Washer	6

## Assembly and Installation Instructions



Review all steps before assembly and read all precautions before using this product. Failure to do so can result in serious injury or death. During periods of non-use, this trampoline and trampoline enclosure can be easily disassembled and stored by reversing the order of installation.

### WARNING

- At least two people are required to assemble the trampoline and trampoline enclosure.
- Protective gloves must be used during assembly to avoid injuries during installation.
- Protective goggles must be worn to avoid injuries to the eyes.

### WARNING

For appropriate use of the trampoline, please assemble the trampoline in a location that meets the following conditions:

- Adequate overhead clearance is needed. A minimum of 26.25 ft (8 metres) from ground level is recommended. Provide clearance for wires, tree limbs and other possible hazards.
- Lateral clearance is essential. Place the trampoline away from walls, structures, fences and other play areas. Maintain a clear space on all sides of the trampoline.
- Place the trampoline on a flat and level surface before use.
- Do not install this trampoline on hard surfaces. Suitable surfaces include grass or sand.
- Use the trampoline in a well-lit area. Artificial illumination may be required for shady areas.
- The trampoline should be installed in an area where access can be restricted from unauthorized and unsupervised use.
- Ensure there is nothing beneath the trampoline that could cause injury or obstruct movement of jump mat.
- Remove any obstructions from beneath the trampoline.
- The trampoline enclosure is only to be used as an enclosure for a trampoline of a size for which the enclosure is designed.
- The owner and supervisors of the trampoline are responsible to make all users aware of practices specified in the use instructions section.
- Users may become entangled in or strangled by loose cords or in gaps between trampoline and enclosure. Keep enclosure tightly fastened to the trampoline in accordance with the manufacturer's instructions. Failure to properly assemble and maintain a tight, secure trampoline/enclosure boundary may result in serious injury, strangulation, or death.

If you do not follow these guidelines, you increase the risk of injury or death.

### PRIOR TO ASSEMBLING

Before assembly, please ensure that you have all the parts required to assemble the product. If you are missing any parts, please contact our Customer Support agents.

### NOTICE

- Please do not use unauthorized parts to assemble the trampoline. This may damage the integrity of the product and will void the manufacturer's warranty.
- DO NOT use electric power tools to tighten or loosen bolts and screws as this can damage the hardware.

## Trampoline Frame Assembly

**BEFORE YOU BEGIN:** Review all steps before assembly and read all precautions before using the trampoline. At least two adults are required to assemble this trampoline. Protective gloves should be used during assembly to avoid **injuries during installation**. Goggles should be worn to avoid injuries to the eyes.

### Step 1 – Frame Assembly

Locate the following 30 pieces of steel tubing parts that are needed to assemble the trampoline frame:

- 6 - Top Rail with Leg Sockets (# 3)
- 6 - Top Rails (# 4)
- 6 - Leg Bases (# 5)
- 6 - Vertical Leg Extensions with one (1) hole (# 6A)
- 6 - Vertical Leg Extensions with two (2) holes (# 6B)

Lay out all the parts on dry flat surface as shown below.

**Note:** All parts with the same number are interchangeable and have no “right” or “left” orientation.

## WARNING

Make sure that you have plenty of space and a clean dry area suitable for the assembly of this trampoline. **IT IS ESSENTIAL THAT THE INTENDED SITE FOR THIS TRAMPOLINE IS COMPLETELY FLAT AND LEVEL.** If the ground is uneven this could cause movement in the frame and could cause stress on the joined sections of the frame that could damage the trampoline and/or can cause serious injury.

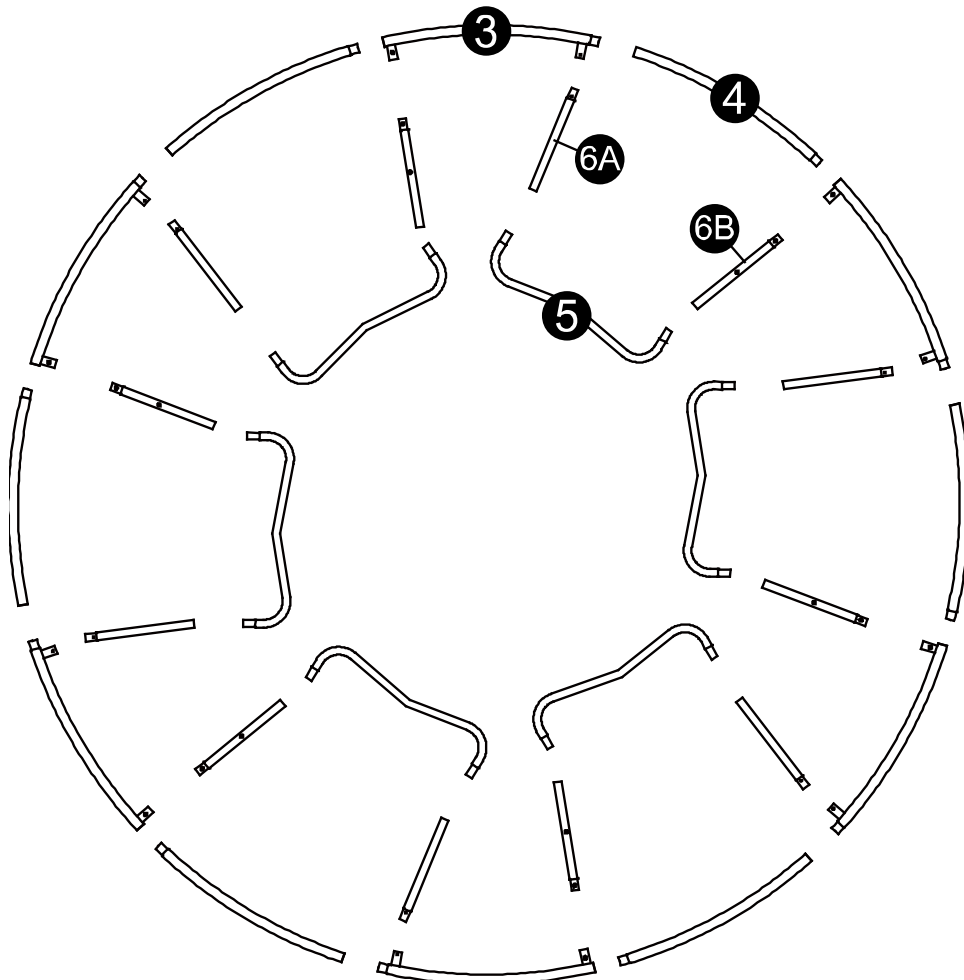

**Step 2 – Leg Support and Top Rail with Leg Socket Assembly**

At this point, two people will be needed to assemble the trampoline.

Connect the Vertical Leg Extensions (# 6A and # 6B) to the Leg Base (# 5) as shown below (the assembled parts will be hereinafter referred to as “Leg Support”).

**Note:** Vertical Leg Extension (# 6B) has two (2) holes.

Lift two sets of the Leg Supports assembled in Step 2 to a vertical (standing) position. Connect one end of the Top Rail with Leg Socket (# 3) to Vertical Leg Extension with one hole (# 6A) and the other side to the Vertical Leg Extension with 2 holes (# 6B) as shown below. Repeat in the same manner for all the Top Rails with Leg Sockets.

**Hint:** Make sure the holes on all the steel tubing parts are aligned and facing outward. This is important for installing the enclosure later.

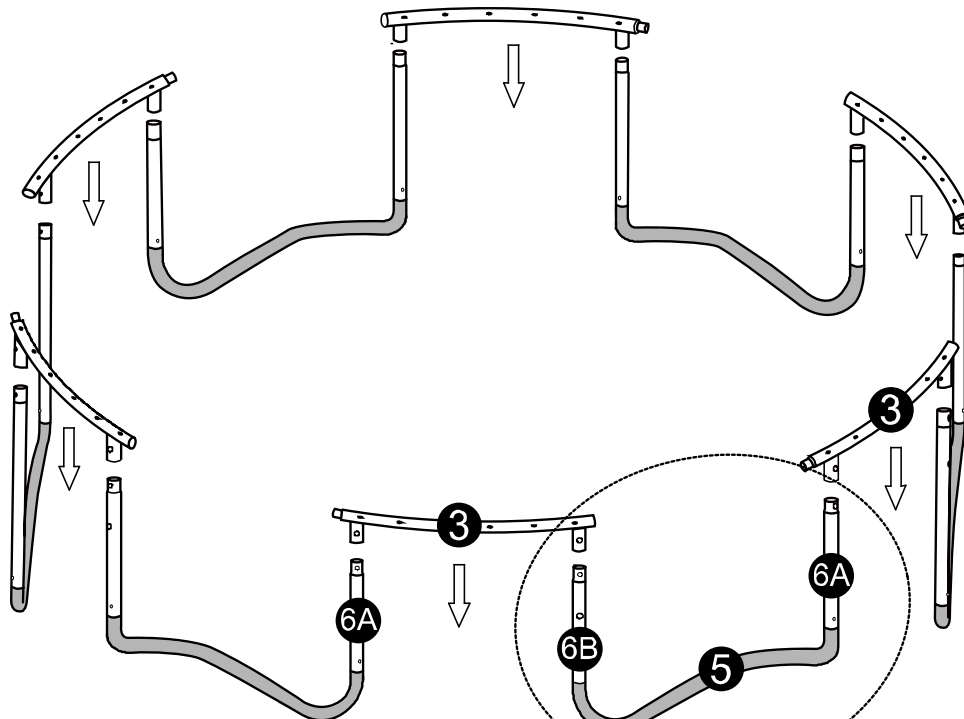

**⚠ WARNING**

**DO NOT PLACE HANDS NEAR THE OPENING WHEN CONNECTING THE TUBES. WEAR PROTECTIVE GLOVES TO PROTECT FROM INJURIES DURING ASSEMBLY.**

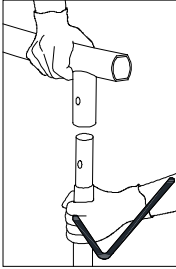

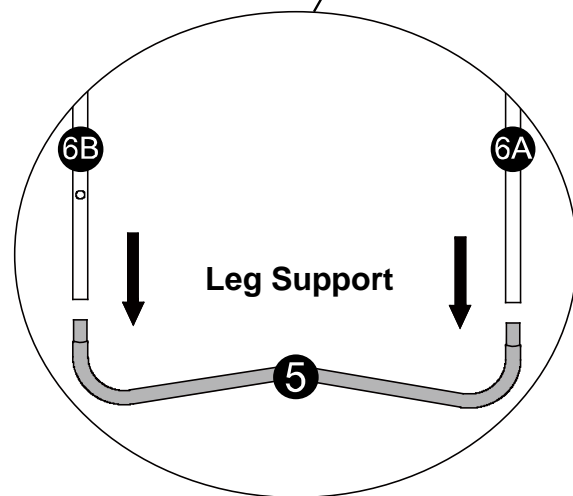

**Step 3 –Top Rail Assembly**

Complete the Trampoline Frame by inserting all of the Top Rails (# 4) into the Top Rail with Leg Sockets (# 3) as shown below.

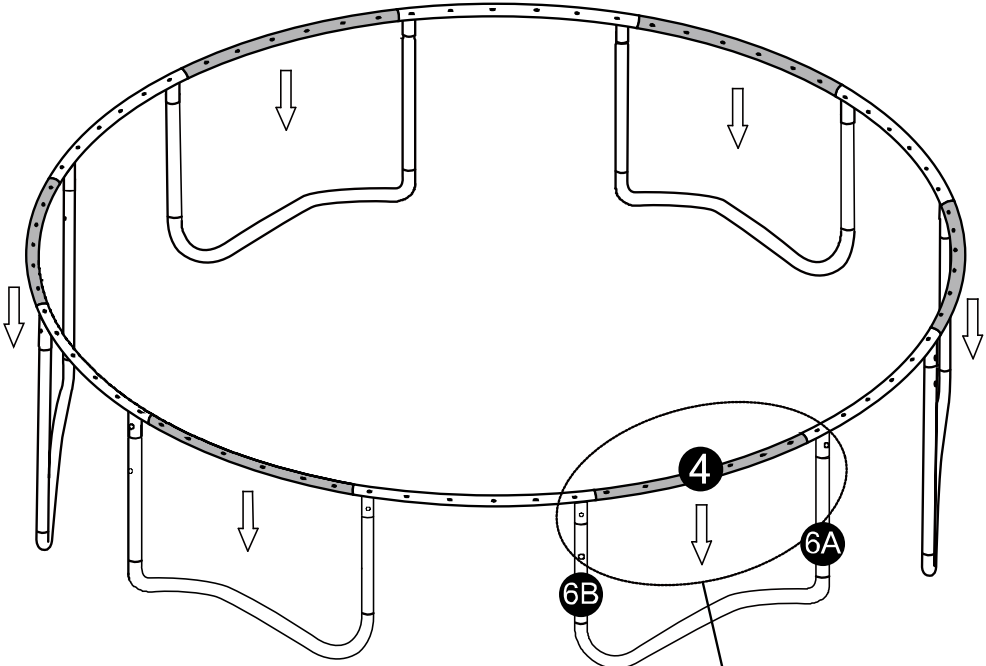

**WARNING**

DO NOT PLACE HANDS NEAR THE OPENING WHEN CONNECTING THE TUBES. WEAR PROTECTIVE GLOVES TO PROTECT FROM INJURIES DURING ASSEMBLY.

The illustration shows two scenarios of connecting tubes. The left scenario shows a hand correctly positioned to guide a tube into a socket, marked with a checkmark. The right scenario shows a hand placed near the opening of the tube, marked with an X, indicating this is an unsafe practice.

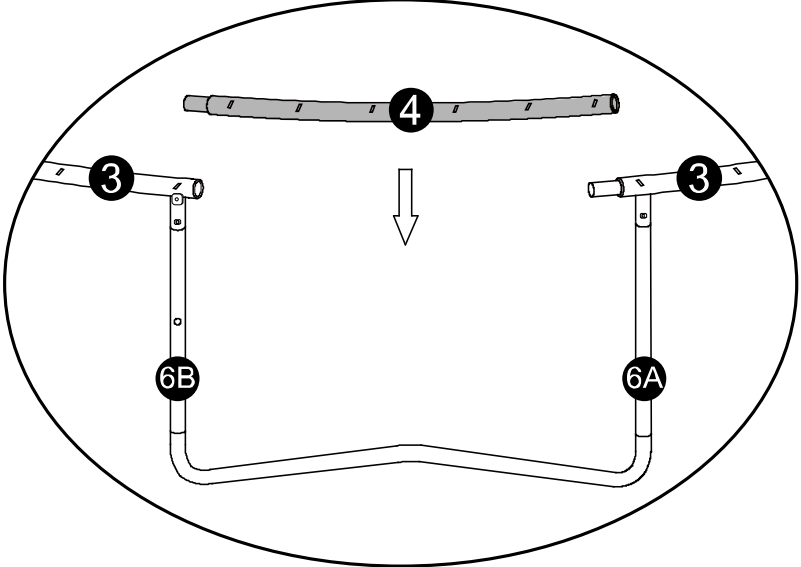

### Step 4 –Secure the Leg Support to the Top Rail

Secure one side of the Leg Support – the Vertical Leg Extension one hole (# 6A), to the frame using Self-Locking Screw (# I), Small Spring Lock Washer (# 10) and Allen Wrench (# K) as shown below. If the holes do not match up, rotate the Vertical Leg Extension back and forth until the holes are aligned. Repeat in the same manner for all the Leg Supports.

#### NOTE:

- The holes on the other side of the Leg Support will be used later when installing the enclosure netting.
- Do not over-tighten the screws at this point. The screws should only be tightened all the way after all the Springs (# 7) have been installed (steps 6-9).

**Hint:** Make sure the holes on all the steel tubing parts are aligned and that indented hole is facing outward. This is important for installing the enclosure later.

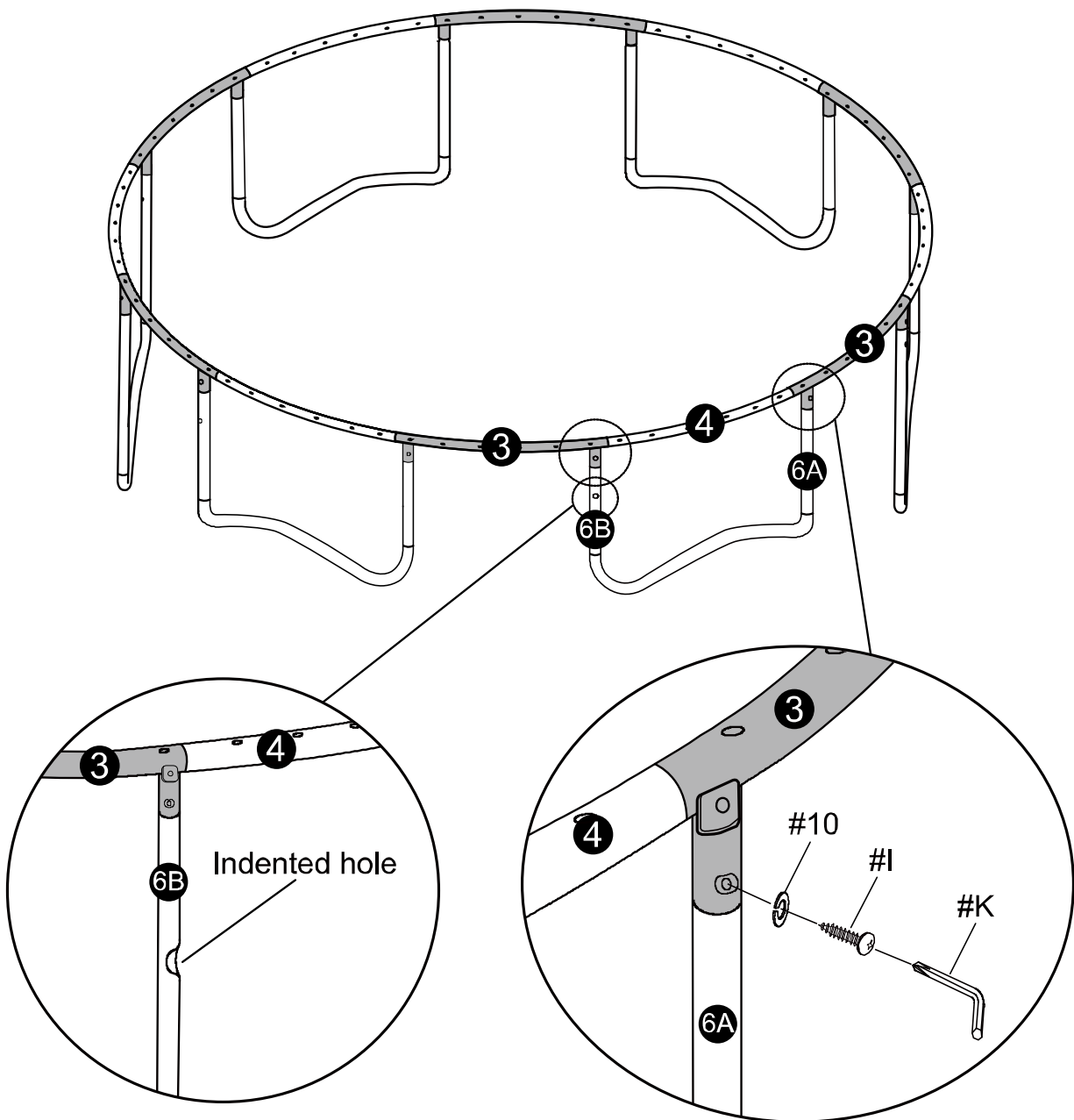

# Trampoline Mat Assembly

## Step 5 – Mat Placement

Place the Trampoline Mat (# 1) flat on the ground inside the assembled frame with the warning labels facing up as shown below. Line up the warning labels with any of the trampoline legs and make sure the warning labels are facing up. This will make the installation process easier.

Select a starting point on the frame and let it be called point “ONE” (choose a point that is located above a leg frame and in front of a warning label).

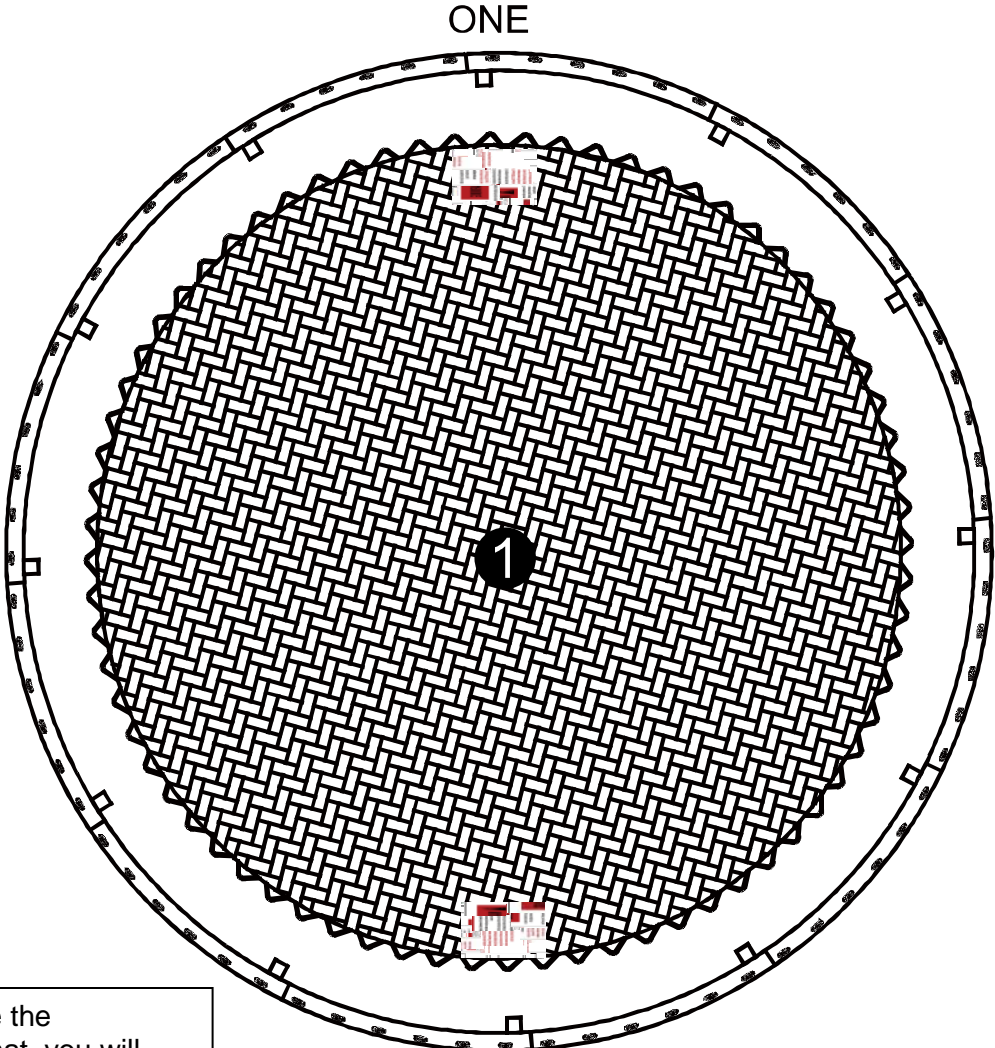

To assemble the trampoline mat, you will only need the Spring Loading Tool (# 9) provided with this product.

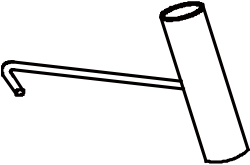

**SPRING LOADING TOOL (# 9)**

**Step 6 – Spring Assembly****⚠ WARNING**

When attaching the springs, do not place your hands, arms, legs or any other body part close to the connector points (i.e. joints connecting the steel tubes). The connector points can become pinch points as the trampoline springs tighten up. Wear heavy duty working gloves to protect your hands from injuries during installation by the springs and protective goggles to avoid injuries to the eyes. Be steady when installing the springs as it can rebound and fly off if you inadvertently let go when not hooked properly. Make sure no children are playing nearby when installing the trampoline.

Starting at point “One”, hook one end of the Spring (# 7) into the Triangle-Ring on the Mat (# 1). Holding the Spring Loading Tool (# 9) underhand, pull the other end of the Spring and lock it into the hole on the frame as shown below.

**Hint:** Tap on the Spring (# 7) with the handle of the Spring Loading Tool to make sure it is securely latched into the hole.

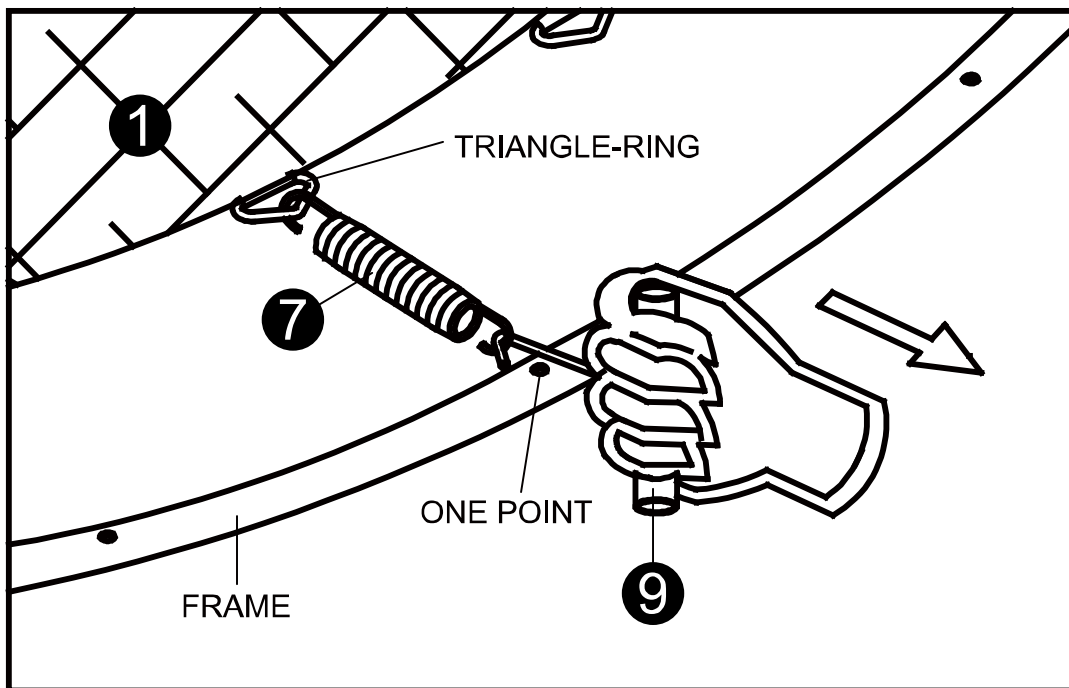

**Step 7 – Spring Assembly**

After you have secured the spring at point “One”, count to hole 37 on the opposite side of the Mat and attach a spring in the same manner as the previous step. For even distribution of spring tension and ease of assembly, the springs must always be installed on opposite sides of the mat in an alternating manner, i.e. One, then 37, followed by 19 and 55 as shown below.

**Hint:** The number of triangle-rings sewn onto the Mat is equal to the number of holes on the frame. If you notice that you have miscounted a hole or triangle-ring, remove and reinstall the springs as necessary while maintaining an even distribution of tension as explained above.

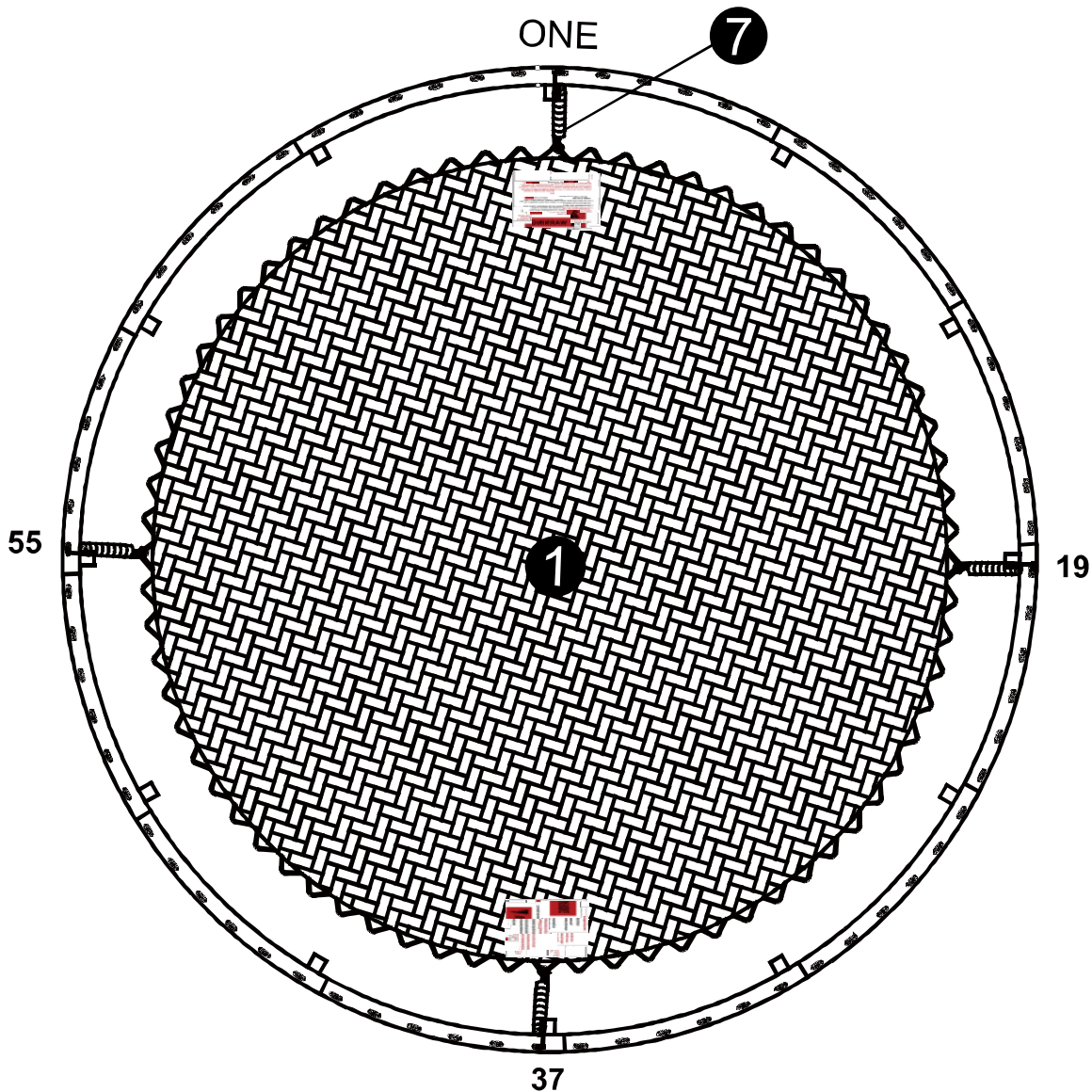

**Step 8 – Spring Assembly**

Attach a spring at every 6<sup>th</sup> hole interval. For even distribution of tension and ease of assembly, the springs must be placed on opposite sides of the mat in an alternating manner, i.e. 7 then 43, 25 then 61, etc. In addition to the previously installed springs, you should now have springs at 7, 43, 13, 49, 25, 61, 31 and 67 as shown below.

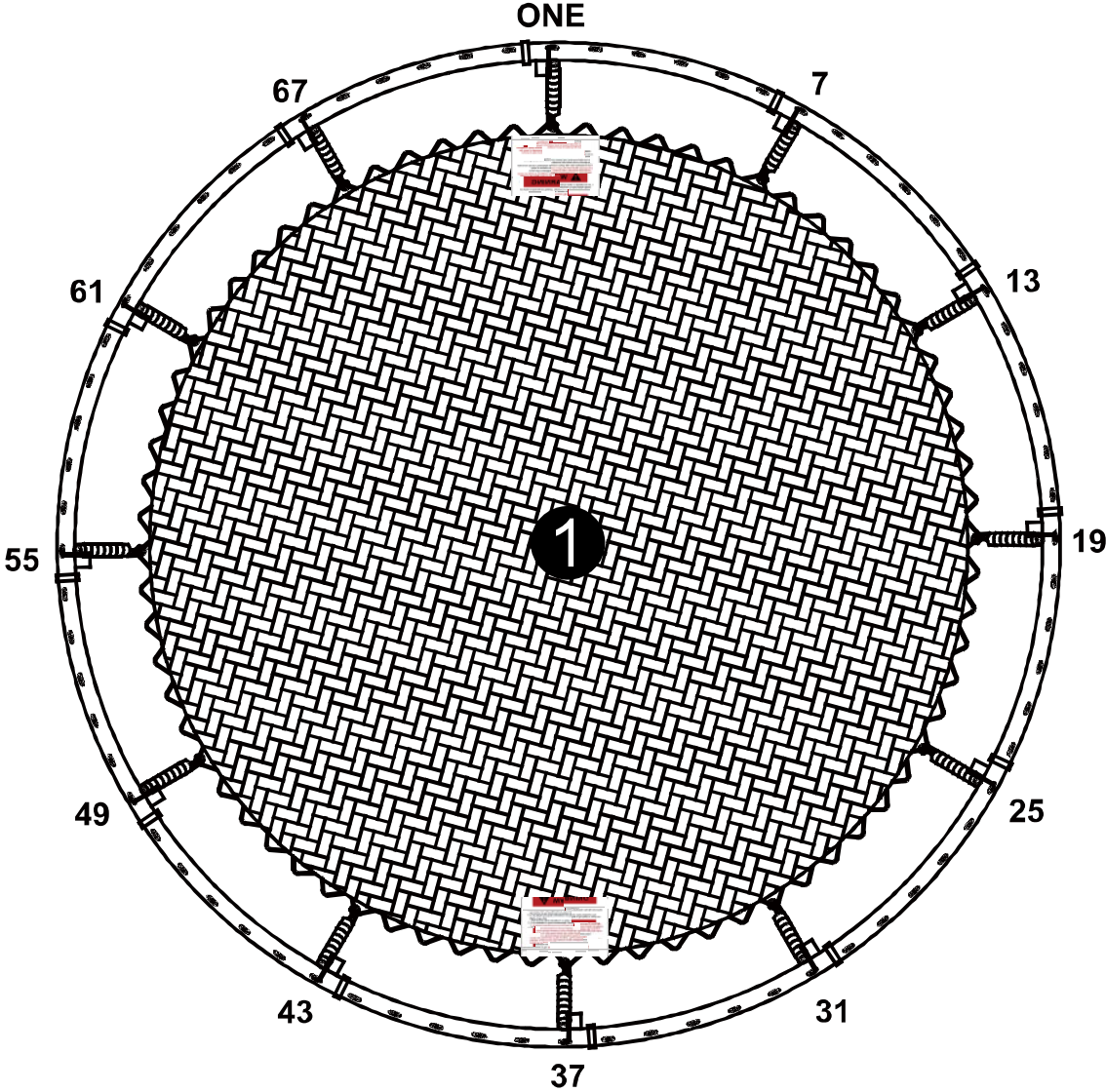

**Step 9**

Continue to attach the remaining 60 springs in the same manner as the previous step, i.e. the springs must be placed on opposite sides of the mat in an alternating manner to ensure even distribution of tension.

Attach Trampoline Safety Instruction Placard (# 8) to the trampoline frame using the strap provided. Make sure the strap is looped around the frame to ensure that it does not slide off the trampoline.

The completed trampoline should look as shown below.

**IMPORTANT:** Once all the springs are properly installed, you must go back to Step 5 and now tighten all the screws on the Leg Supports.

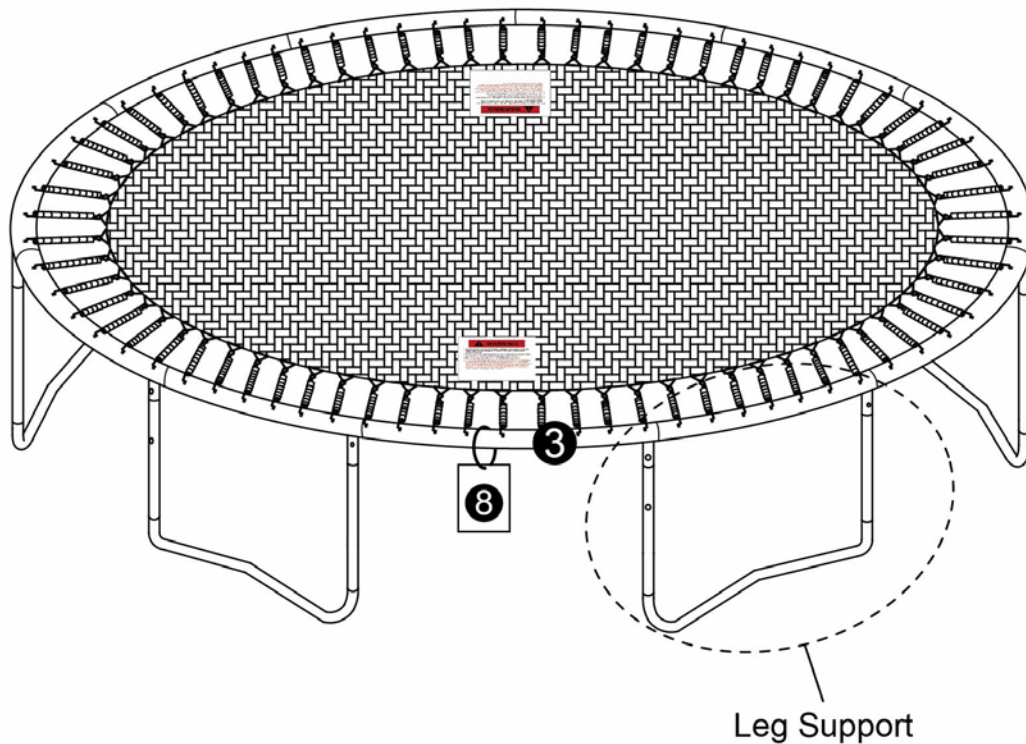

## Frame Pad Assembly

### **!** WARNING

Never use the trampoline without the Frame Pad, the Frame Pad reduces the risk of getting injured by hitting the metal frame or springs. Inspect the Frame Pad before each and every use to ensure all exposed metal parts are fully covered by the Frame Pad!

#### Step 10

Lay the Frame Pad (# 2) over the trampoline so that the springs and steel frame are fully covered. Next, line up the elastic straps to the leg sockets and wrap the elastic straps **BEHIND** the leg sockets. First, tie a knot and then a one-sided bow as shown below. Repeat this step for all of the outer straps.

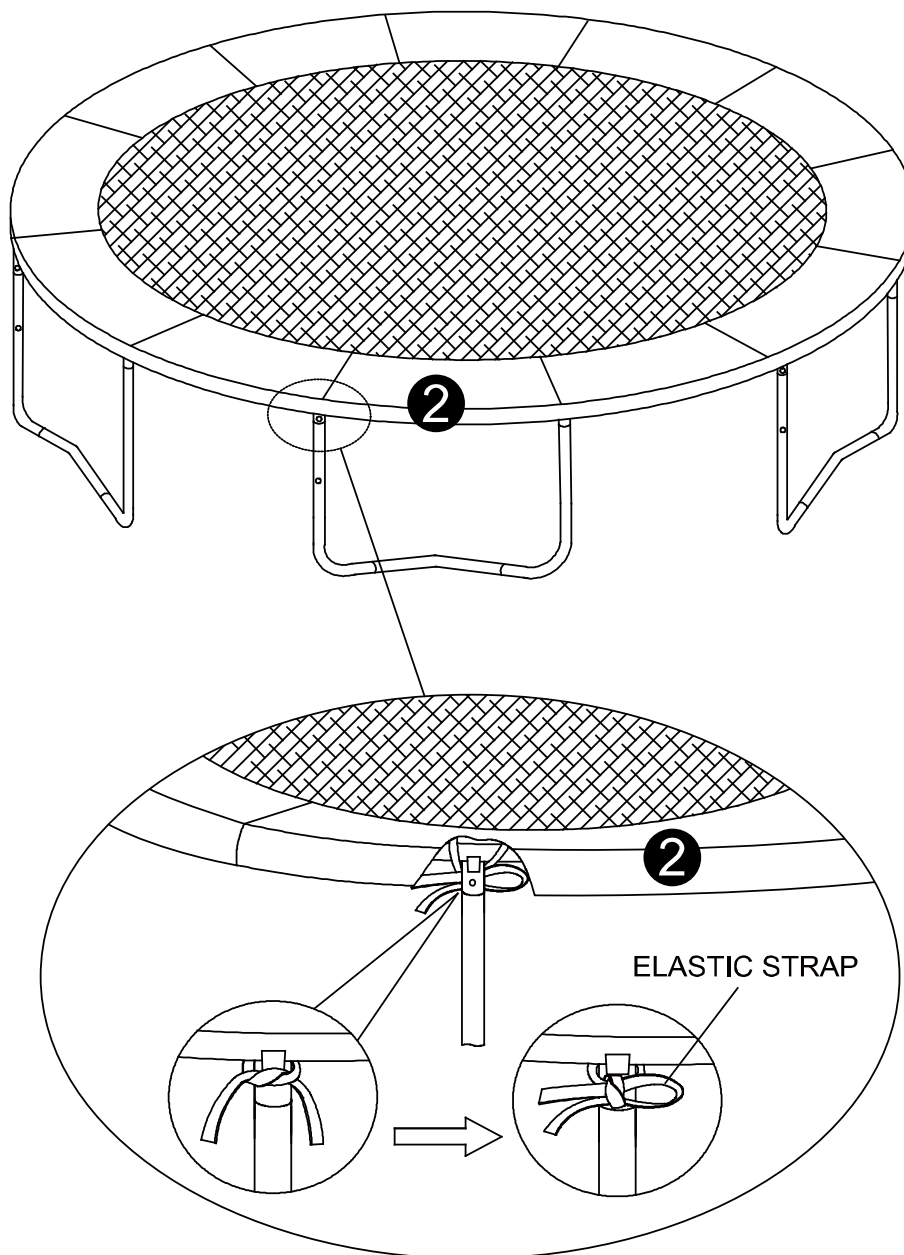



## Trampoline Enclosure Assembly

### WARNING

#### BEFORE YOU BEGIN:

- This trampoline should only be used when the enclosure netting is properly assembled. The trampoline netting must be checked thoroughly before each use to ensure there are no tears or damages. Please carefully read all the Important Safety Instructions contained in this manual and all warnings on the product before use.
- Review all steps before assembly and read all precautions before using the trampoline. At least two adults are required to assemble this trampoline enclosure. Protective gloves should be used during assembly to avoid injuries during installation by the hooks and goggles should be worn to avoid injuries to the eyes.

#### Step 11 – Assemble the Enclosure Poles

First, attach End Cap (# O) to the Lower Frame Tube with Foam (# B) – the side with the larger opening. Next, place the Lower Frame Tube with Foam (# B) next to the Leg Support (i.e. the side with 2 holes) and secure them together using Bolt (# F), Gap Spacer (# E), Arc Washer (# J), Large Spring Lock Washer (# G) and Cap Nut (# H) in the order shown below. Repeat this step for all the frame tubes.

#### IMPORTANT:

- The smaller arc of the Gap Spacer (# E) must face the Lower Frame Tube with Foam (# B).
- All three holes on the Lower Frame Tube with Foam (# B) are facing outward. The two holes not covered by the foam tube are used for attachment to the Leg Frame. The other hole located at the top (which may be covered by the foam) is used for connection to the Upper Frame Tube with Foam (# A2) at a later step.
- There may be some deformation of the foam on the enclosure tubes due to compression during transport. This is normal and the shape of the foam should recover naturally over time.

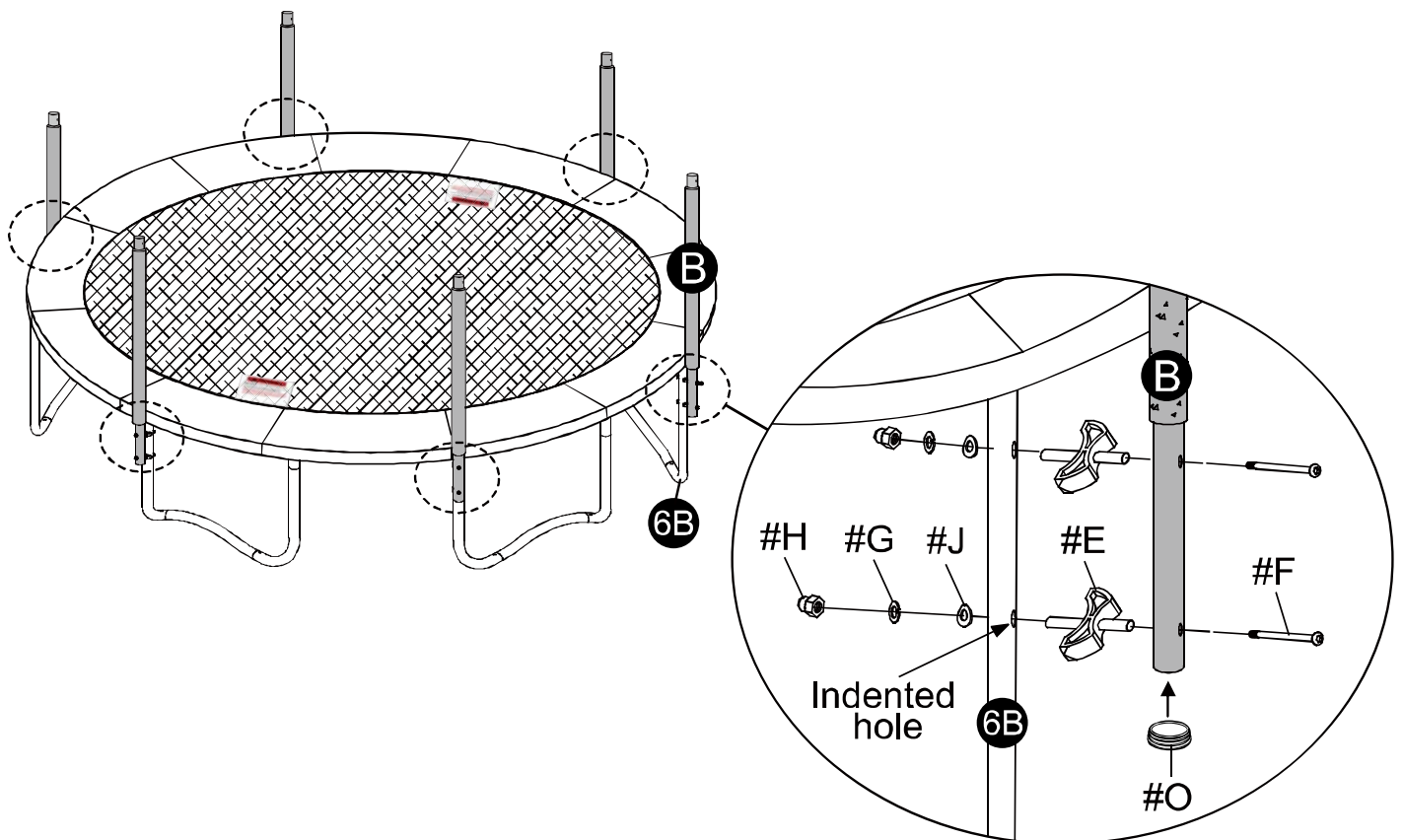

**Step 12 – Assemble the Enclosure Top Frame**

- There are twelve Flat Steel (# C1) that will connect together to create the enclosure frame.
- Connect one end of Flat Steel (# C1) to one side of Flat Steel Sockets (# C2) using Bolt (# P) and Cap Nut (# Q). Secure it tightly using the Allen Wrench (#K) and the Wrench (# D).
- Repeat this process for all Flat Steel (# C1).
- Connect the ends of Flat Steel (# C1) that do not have the Flat Steel Sockets (# C2) to the other completed pieces that do have Flat Steel Sockets (# C2). Repeat this step until you have 2 long separate pieces.
- Insert the two sets of assembled Flat Steel into the sleeve opening at the top of the enclosure.

**Note:** They should be facing opposite ends of each other if done correctly as seen on the enlarged diagram.

**⚠ WARNING**

Please make sure to securely fasten the Flat Steel together. Failing to do so may increase the chance of injury due to the enclosure frame snapping apart during assembly or trampoline use.

1.

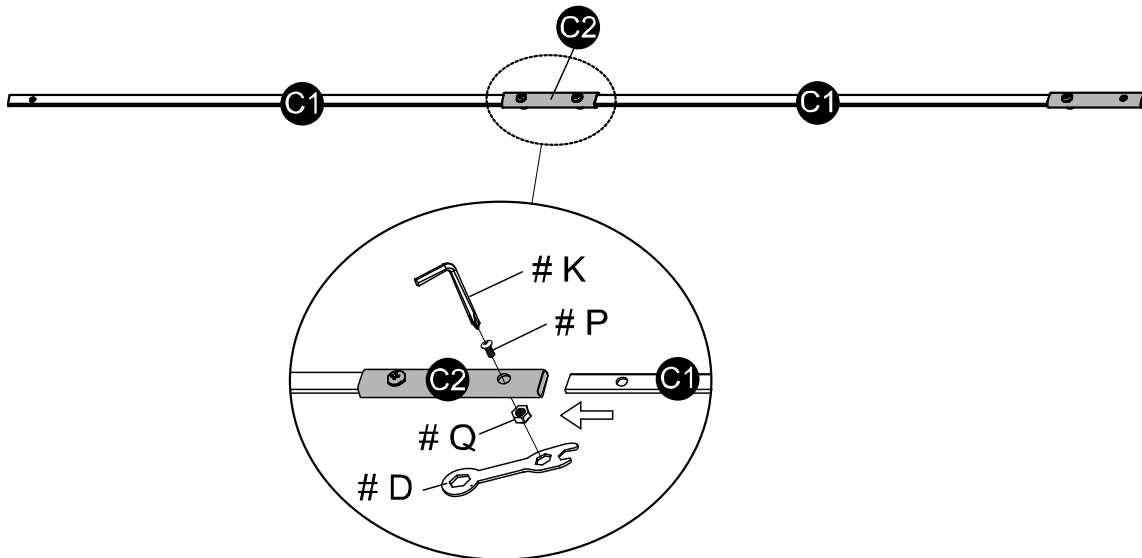

2.

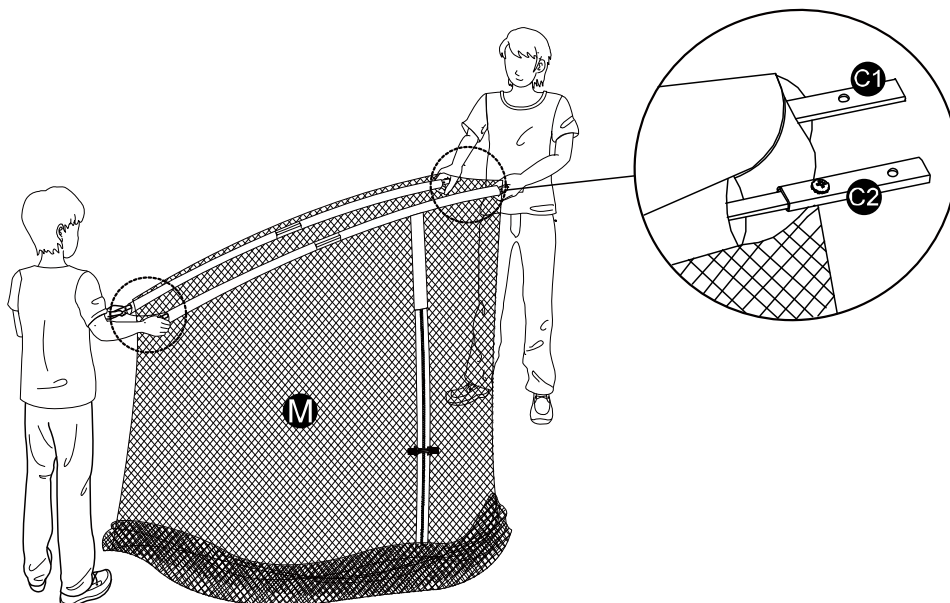

## ! WARNING

- Three adults are needed for this step. Please ensure that all the Flat Steel Sockets (# C2) are installed correctly and are tightly fastened before proceeding.
- Warning: During the installation process, make sure that the Flat Steel (# C1) parts are held firmly with a tight grip. Failure to do so may cause the metal to flex back and may cause injury.

With two people firmly holding the ends of the assembled Flat Steel (# C1), push inward to form a circle. Connect the ends of the Flat Steel Sockets (# C2), align the holes and secure with using Bolt (# P), Cap Nut (# Q), Allen Wrench (# K) and Wrench (# D) as shown below. This should be done by the third person while the other two people are firmly holding the ends of the Flat Steel in place.

**NOTE:** Once the enclosure frame is assembled, slide the connection points so that they are inside the enclosure sleeve and not showing.

3.

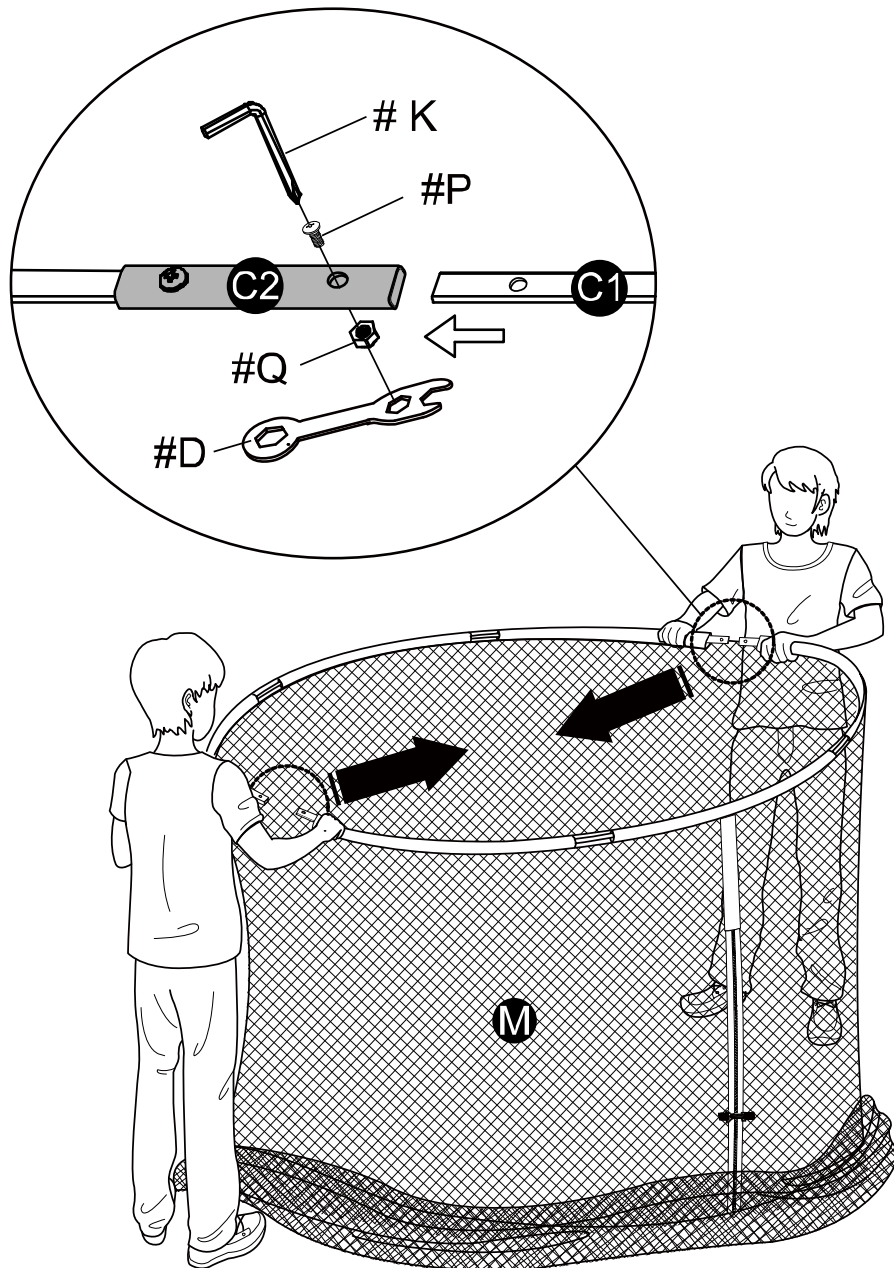

**Step 13 – Attach the Enclosure Netting to the Enclosure Top Frame**

Attach Plastic Cap (# R) to the curved end of Upper Frame Tube with Foam (# A2), Secure with Self-Locking Screw (# I) and tightening using Allen Wrench (# K).

Attach the assembled Plastic Cap (# R) to the Flat Steel (# C1) as shown below. Repeat in the same manner for all of the Flat Steel.

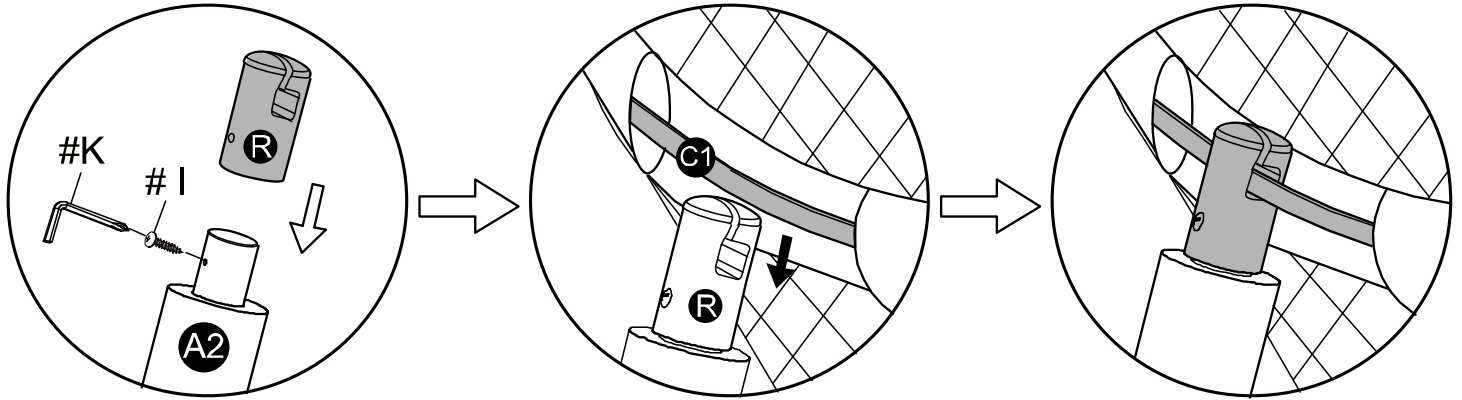

**Step 14 – Connect the Enclosure Upper Frame to the Lower Frame**

Connect all six Upper Frame Tube with Foam (# A2) to the Lower Frame Tube with Foam (# B), and secure with Self-Locking Screw (# I) using Allen Wrench (# K) as shown below.

**Helpful Tips:** One person should stand inside the trampoline to hold the netting in place while another person installs all the frame tubes from the outside.

**NOTE:** Make sure the enclosure is assembled so that the entrance is aligned with the warning label on the frame padding.

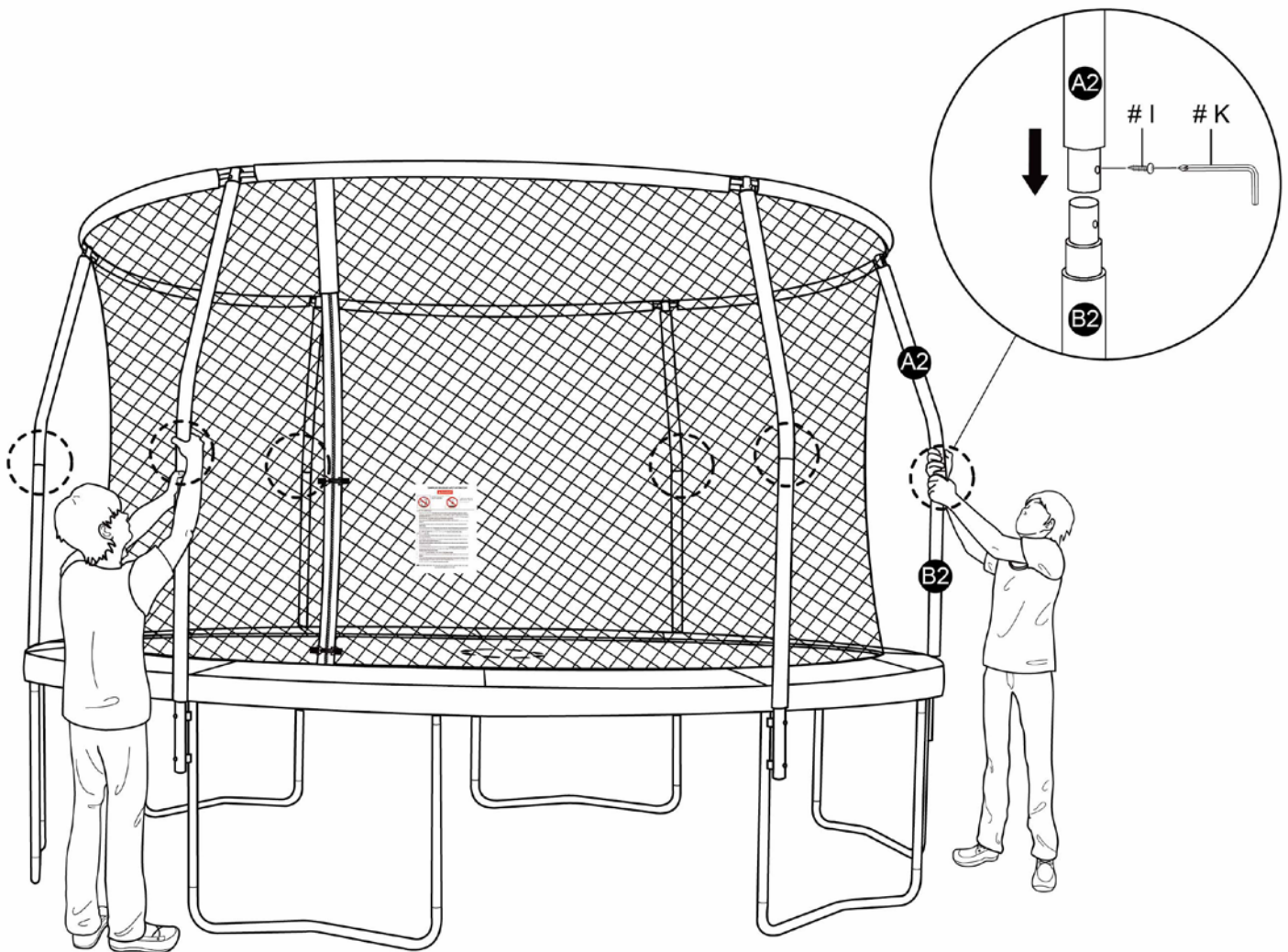

**Step 15 – Tie the Enclosure to the Mat**

Secure the trampoline netting to the trampoline frame using the Cords (# L). Lift up the frame pad and tie one end of the cord to any one of the Triangle-Rings on the trampoline mat as shown below.

Loop the other end of the cord through the next hole on the mat and then the adjacent triangle-ring. Continue in the same manner until the end of the cord is reached and tie it to a triangle-ring. Repeat the same process for all the cords provided until the enclosure netting is fully secured to the trampoline mat.

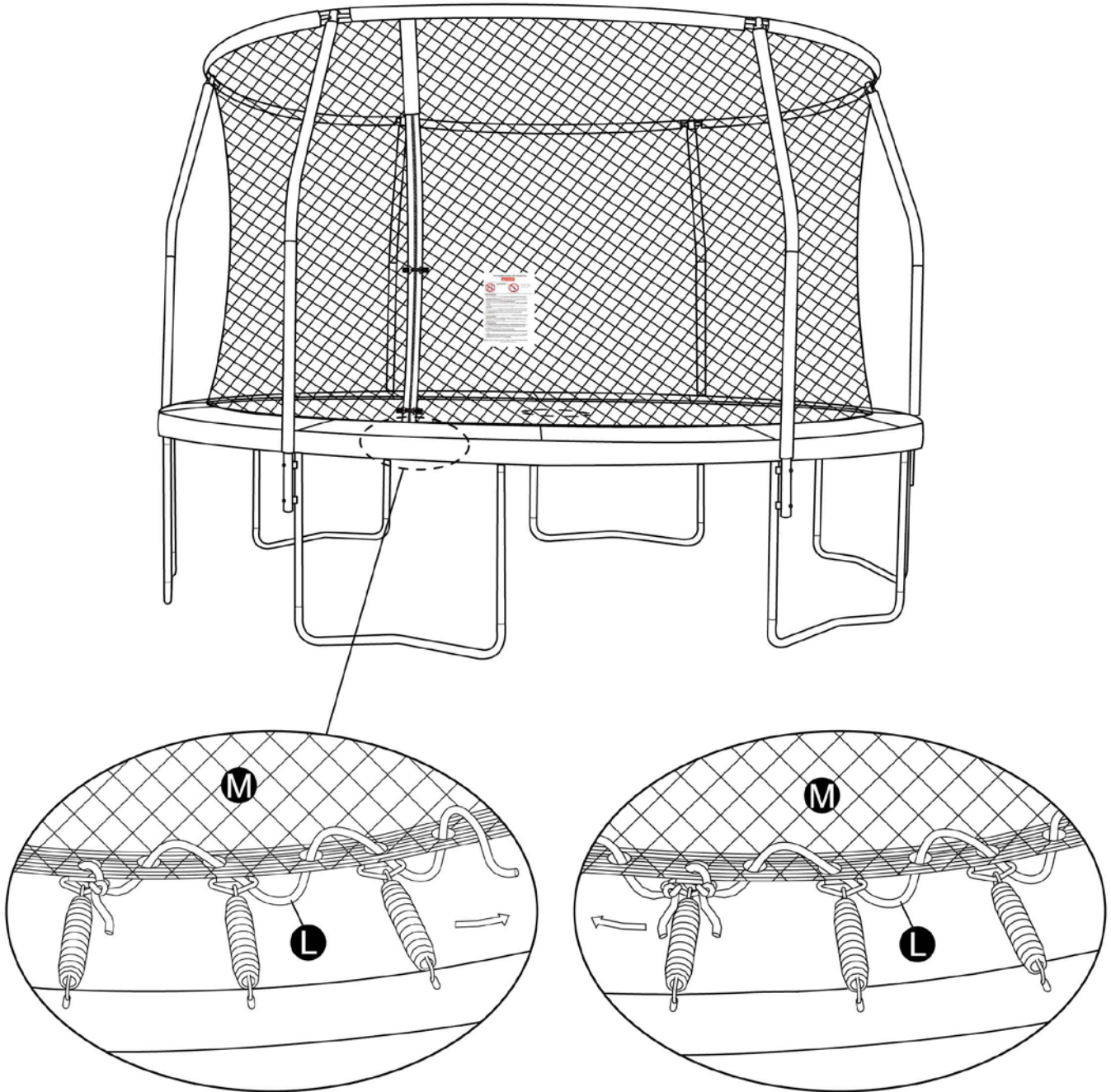

**Step 16– Closing the Enclosure**

Close the zipper which is located at the entrance of the Enclosure Netting (# M) and secure the entrance by connecting the hooks into the Triangle-Rings as shown below.

**⚠ WARNING**

The zipper and buckles should be closed during use to avoid users falling out of the trampoline, as well as during periods of non-use to restrict access by unauthorized users.

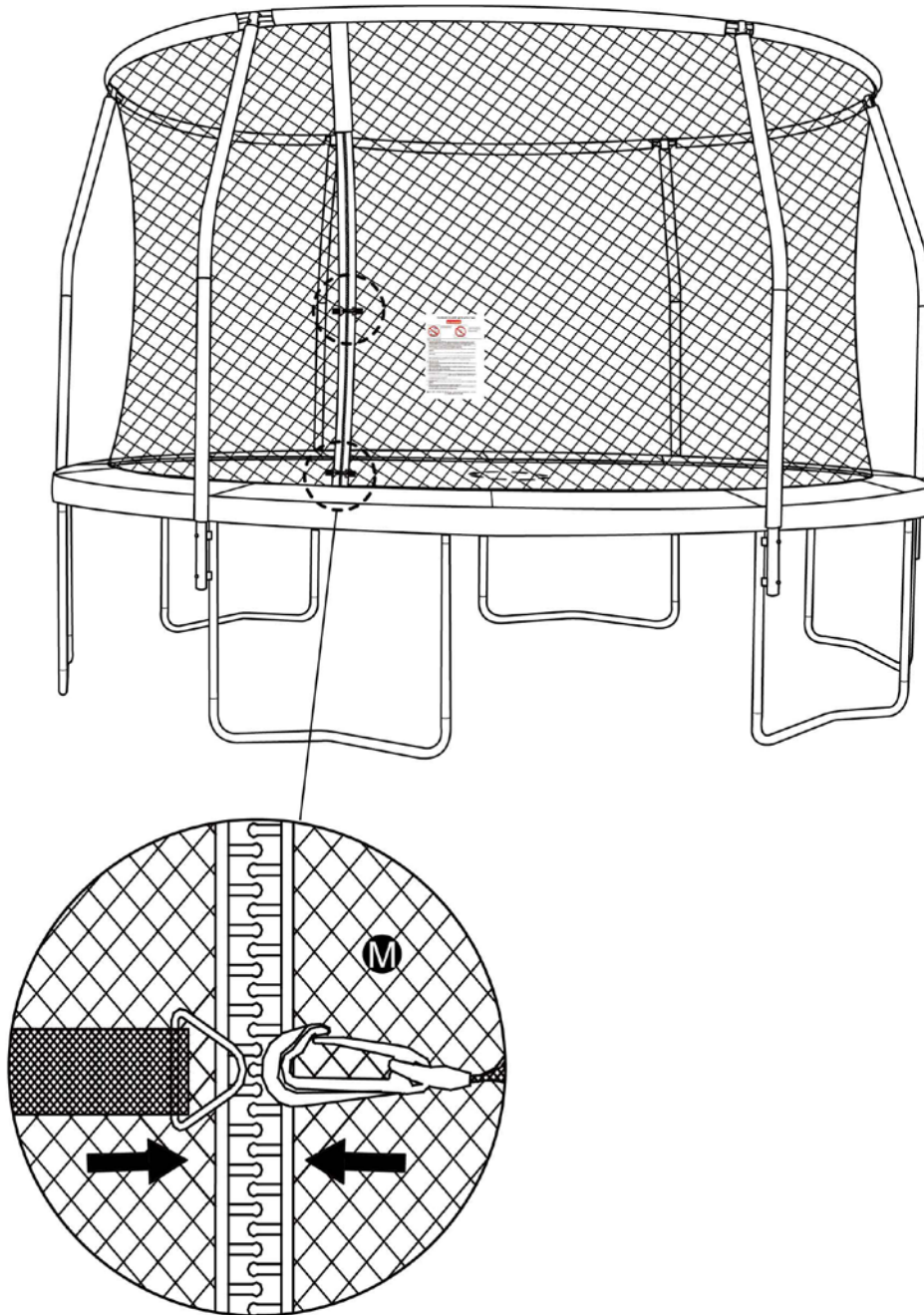

**Step 17**

Finally, wrap and tie the inner elastic straps around the triangle-ring as shown below. Repeat this step for all of the inner straps.

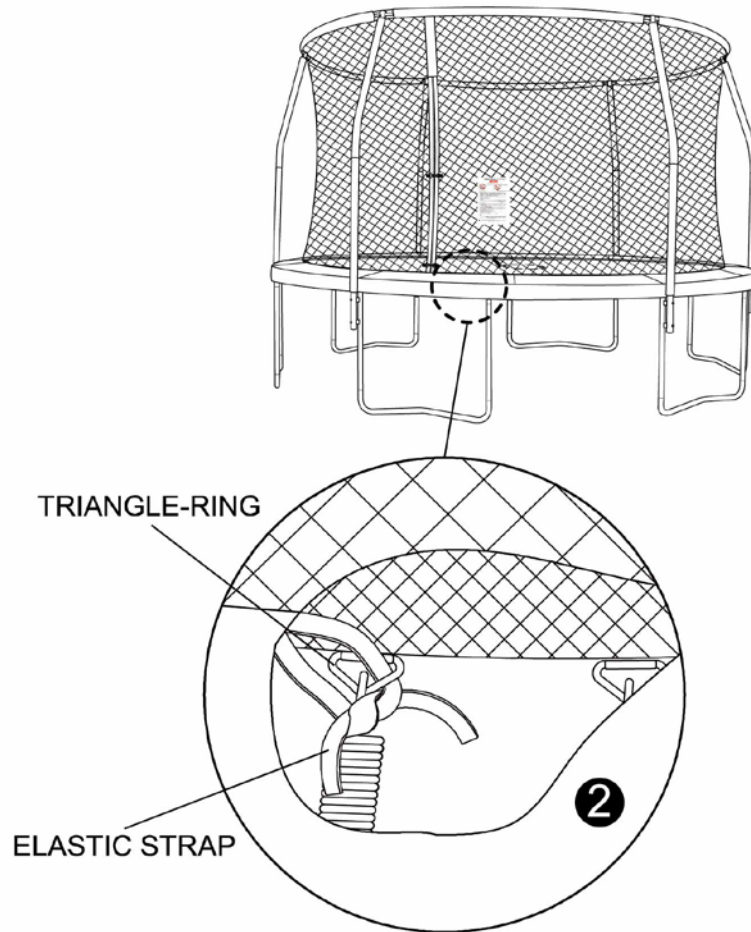
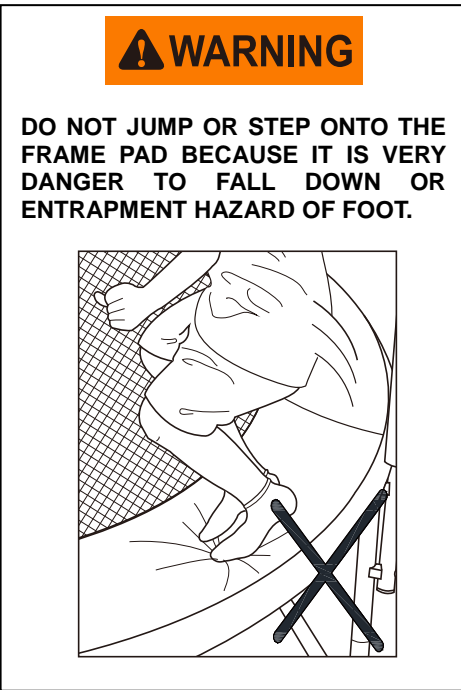

**WARNING**

- Make sure that the knots and bows are tight for all elastic straps.
- Make sure the Frame Pad is securely attached to the frame and completely covers the frame and all of the springs before using this trampoline. Do not use the trampoline if even one spring or triangle-ring is damaged or missing.
- Perform a complete inspection of the trampoline to make sure all parts are assembled and attached properly.
- Read this entire manual and make sure all jumpers completely understand all of the safety rules printed in the manual and on the various warning signs. Instruct all jumpers on the basic bounces described in the manual.

**WARNING**

Do not attempt to disassemble any frame components until all of the springs and the trampoline mat have been removed. Wear heavy duty working gloves to protect your hands from injuries during installation by the springs and protective goggles to avoid injuries to the eyes.



## **IMPORTANT**

Once you have finished the assembly of the trampoline, go back over all of the nuts and bolts and properly tighten all of them before using.

Read this entire manual and make sure all jumpers completely understand all of the safety rules printed in the manual and on the various warning signs. Instruct all jumpers in the basic bounces described in the manual.

**CARE AND MAINTENANCE AND USE INSTRUCTIONS MUST BE READ CAREFULLY BEFORE USING THE TRAMPOLINE. ADULT SUPERVISION IS REQUIRED AT ALL TIMES.**

## **Disassembly of the Trampoline and Enclosure**

If you need to disassemble the trampoline, please follow the assembly instructions in reverse and take special care to retain all parts. Retain the original packaging for transport purposes.

## **Moving the Trampoline and Enclosure**

To move the trampoline, it is recommended for the trampoline to be disassembled and then reassembled in the new location. However, if you need to move the trampoline a short distance for any reason, you must use duct tape or heavy industry tape to tape all leg joints together. To move the trampoline requires two or more people to lift the trampoline from contact with the ground. Do not drag the trampoline along the ground. The trampoline must be kept steady and horizontal to the ground during the move. Failure to follow these instructions may result in the leg support coming loose which may cause serious injury or death.

## **WARNING**

**DO NOT USE THE TRAMPOLINE WHEN THE ENCLOSURE IS REMOVED**

## Care and Maintenance



**Failure to follow these instructions to ensure proper operational condition of your trampoline may lead to serious injury or death.**

### **WARNING**

- The hooks, trampoline legs and enclosure netting must be inspected prior to every use. The legs should be locked securely into place, all the hooks attached to the frame and there should be no tears in the enclosure netting. If any part becomes damaged or worn, please stop using the trampoline immediately until this part is replaced with authorized parts.
- If you see any signs of stretched or damaged hooks, do not use the trampoline until replacement hooks are properly installed. Please contact our customer service representatives to order original replacement parts.
- Please do not use unauthorized parts to assemble the trampoline. This may damage the integrity of the product and can cause injuries during use.
- To move the trampoline, it is recommended for the trampoline to be disassembled and then reassembled in the new location. However, if you need to move the trampoline a short distance for any reason, you must use duct tape or heavy industry tape to tape all leg joints together. To move the trampoline requires two or more people to lift the trampoline from contact with the ground. Do not drag the trampoline along the ground. The trampoline must be kept steady and horizontal to the ground during the move. Failure to follow these instructions may result in the leg support coming loose which may cause serious injury or death.
- The trampoline and enclosure must be stored away during harsh weather conditions including extreme wind, heat and freezing temperatures.
- Always properly store away the trampoline and enclosure when not in use and secure from any unauthorized use.
- Inspect the trampoline before each use and replace any worn, defective or missing parts. The following conditions could represent potential hazards:
  - Missing, improperly positioned or unsecured enclosure support system, frame padding and pole caps
  - Punctures, frays, tears or holes in the trampoline mat or enclosure support system or frame padding
  - Deterioration in the stitching or fabric of the mat, enclosure netting or frame padding
  - Ruptured or loose hooks
  - Bent or broken support system (frame)
  - Sagging trampoline mat and/or sagging enclosure netting
  - Sharp protrusions on the support (frame) or suspension system
- If you live in area with high salt and moisture content in the air, we strongly recommend that you paint the trampoline frame and hooks with a rust resistant clear coat paint to add protection to the steel components.

## Proper Use Instructions



**Read and understand the use instructions in this manual prior to using this product. Failure to do so can result in serious injury or death.**

### Responsibilities of the user

The key here is to stay in control of your jumps. DO NOT move onto more complicated, more difficult maneuvers until you have mastered the basic, fundamental bounce. Read, understand, and practice all precautions and warnings prior to using the trampoline. A controlled jump is when you land and take off from the same location. For additional tips and instructions, contact a certified trampoline instructor.

### Supervisor's or owner's role in preventing injuries

It is the responsibility of the supervisor(s) of the trampoline users to provide knowledgeable and mature supervision. They need to know and enforce all the rules and warnings set forth in this manual in order to minimize the likelihood of accidents and injuries and to inform users of these rules. During the periods of time when supervision is unavailable or inadequate, the trampoline should be disassembled and stored in a secure place to prevent unauthorized use. The supervisor is also responsible to ensure that the safety placard is placed on the trampoline and that the jumpers are informed of these warnings and instructions.

**⚠ DANGER**

### **All jumpers need to be supervised, regardless of skill level or age.**

- DO NOT attempt or allow somersaults. Landing on the head or neck can cause serious injury, paralysis or death, even when landing in the middle of the mat.
- Do not allow more than one person on the trampoline. Use by more than one person at the same time can result in serious injuries.
- Trampolines over 20 inches (51 cm) tall should not be used by children under six (6) years of age.
- Wear clothing free of drawstrings, hooks, loops or anything that could get caught while using the trampoline/enclosure and result in entanglement or strangulation, or both.
- Climb on and off the trampoline. It is a dangerous practice to jump from the trampoline to the floor or ground when dismounting, or to jump onto the trampoline when mounting. Do not use the trampoline as a springboard to other objects.
- Keep enclosure tightly fastened to the trampoline in accordance with the manufacturer's instructions. Failure to properly assemble and maintain a tight, secure trampoline/enclosure boundary may result in serious injury, strangulation or death.
- Completely close the opening of the enclosure before jumping. Close the opening of the enclosure after using the trampoline.
- Do not use the trampoline while under the influence of alcohol or drugs.
- Do not attempt to jump over the enclosure barrier.
- Do not intentionally rebound off the enclosure barrier.



**Read and understand the use instructions in this manual prior to using this product. Failure to do so can result in serious injury or death.**

**WARNING**

- Read all instructions before using the trampoline. Warnings and instructions for the care, maintenance and use of this trampoline are included to promote proper and enjoyable use of this equipment.
- Inspect the trampoline before each use. Make sure the frame padding, enclosure and the enclosure support (frame) padding is correctly and securely positioned. Replace any worn, defective or missing parts before using.
- Use trampoline only with mature, knowledgeable supervision.
- Check for loose cords and gaps. Users may become entangled in or strangled by loose cords or in gaps between trampoline and enclosure.
- Use trampoline only when the surface of the mat is dry. Wind or air movement should be calm to gentle. The trampoline must not be used in gusty or severe winds.
- Keep objects away which could interfere with the jumper. Maintain a clear area under, above, and around the trampoline.
- Do not attempt to crawl under the barrier.
- Do not hang from, kick, cut or climb on the barrier.
- Do not attach anything to the barrier that is not a manufacturer-approved accessory or part of the enclosure system.
- Enter and exit the enclosure only at the enclosure door.
- Learn fundamental bounces and body positions thoroughly before trying more advanced skills. A variety of trampoline activities can be carried out by performing the basic fundamentals in various series and combinations, performing one fundamental after another, with or without feet bounces between them.
- Stop bounce by flexing knees as feet come into contact with the trampoline mat. Learn this skill before attempting others.
- Avoid bouncing too high. Stay low until bounce control and repeated landing in the center of the trampoline can be accomplished. Control is more important than height while keeping the head erect, focus eyes on the trampoline toward the perimeter. This will help control the bounce.
- Avoid bouncing when tired. Keep turns short.
- Limit the time of continuous usage. Make regular stops. Do not jump when tired.
- Properly secure the trampoline when not in use. Protect it against unauthorized use. If a trampoline ladder is used, the supervisor should remove it from the trampoline when leaving the area to prevent unsupervised access by children under six (6) years of age.
- For information concerning skill training, contact a certified trampoline instructor.
- For additional information concerning the trampoline equipment, contact the manufacturer.

## Learning the fundamental trampoline skills

The following lessons are suggested for you to learn basic steps and bounces. Before using the trampoline, you should read and understand all warnings. A complete discussion and demonstration of body mechanics and trampoline guidelines should occur between the supervisor and student as well. The bounces are diagrammed on the following page.

### Lesson 1

- A. Mounting and Dismounting – Demonstration of proper techniques
- B. The Basic Bounce – Demonstration and practice
- C. Braking (Check the Bounce – Demonstration) and practice. Learn to brake on command
- D. Hands and Knees Bounce – Demonstration and practice. Stress should be on four-point landing and alignment

### Lesson 2

- A. Review and practice of techniques learned in Lesson 1
- B. Knee Bounce – Demonstration and practice. Learn the basic down to knee and back up before trying half twist to left and right
- C. Seat Bounce – Demonstration and practice. Learn basic seat bounce then add a knee bounce, hands and knees repeat

### Lesson 3

- A. Review and practice skills and techniques learned in previous lessons
- B. Front Drop – To avoid mat burns and teach the front bounce position, all students should be requested to assume the prone position (face down on the ground) while the instructor checks for faulty positions that could cause injury
- C. Start with a Hands and Knees bounce and then extend body into prone position and on the mat and return to feet
- D. Practice Routine – Hands and Knees Bounce, Front Bounce, return to feet, Seat Bounce, return to feet, Seat Bounce, return to feet

### Lesson 4

- A. Review and practice skills and techniques learned in previous lessons
- B. Half – Turn
  - i. Start from front drop position and as you make contact with mat, push off with arms in either the right or left direction and turn head and shoulders in same direction
  - ii. During turn, be sure to keep back parallel to mat and head up
  - iii. After completing turn, land in the Front Drop position

After completing this lesson, the student now has a basic foundation of trampoline bounces. Jumpers should be encouraged to try and develop their own routines with the emphasis on control and form.

A game that can be played in order to encourage students to try developing routines is “BOUNCE”. In this game, players count off from 1 to X. Player one starts with a maneuver. Player two has to do Player one’s maneuver and add on another. Each player must do the routine properly in the correct sequence. The first person to miss receives the letter “B”. This continues until someone spells out the word “BOUNCE”. The last remaining contestant is deemed the winner! Even when playing this game, it is important to perform your routines under control and not try difficult or highly skilled bounces that you have not yet mastered.

A certified trampoline instructor should be contacted to further develop your trampoline skills.

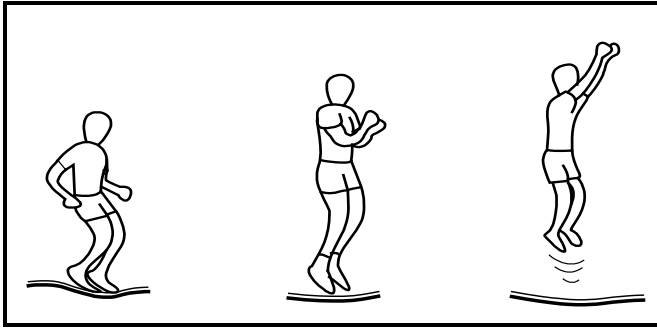
**BASIC TRAMPOLINE BOUNCES****THE BASIC BOUNCE**

1. Start from the standing position, with your feet having shoulder width apart and with head up and eyes on mat
2. Swing arms forward and up in a circular motion
3. Bring feet together while in mid-air and point toes downwards.
4. Keep the feet shoulder width apart when landing on mat

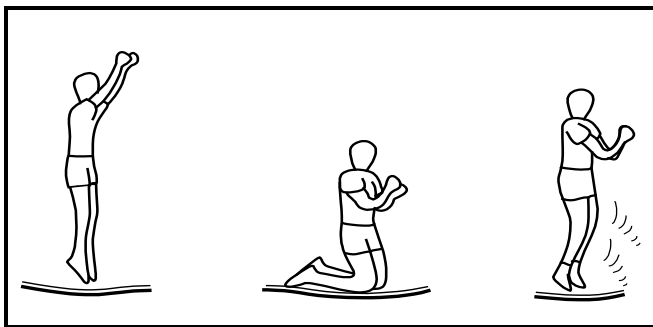
**THE KNEE BOUNCE**

1. Start with the basic bounce and keep it low
2. Land on knees while keeping your back straight and body erect while using your arms to maintain balance
3. Bounce back to basic bounce position by swinging arms up

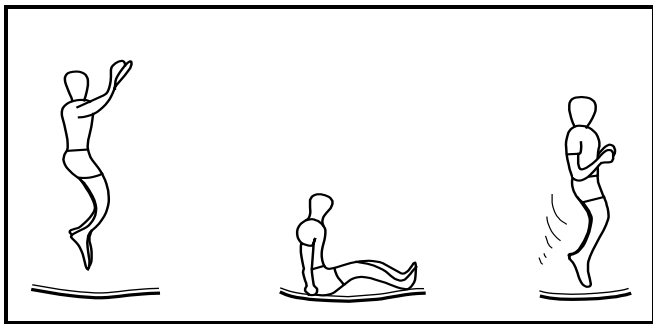
**THE SEAT BOUNCE**

1. Land in a flat sitting position
2. Place hands on mat besides hips, but do not lock your elbow
3. Return to erect position by pushing with hands

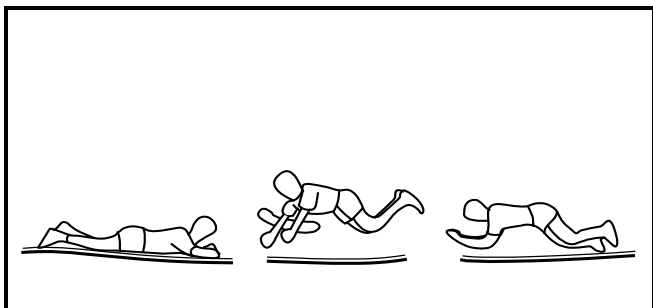
**THE 180 DEGREE BOUNCE**

1. Start with the Front Bounce position
2. Push off with left or right hands and arms (depending on which way you wish to turn)
3. Maintain head and shoulders in the same direction while keeping your back parallel to the mat and your head up
4. Land in the Prone position and return to standing position

## Product Warranty

This product is warranted to be free from defects in material and workmanship under normal use and service conditions for ninety (90) days after the date of purchase. The frame on trampolines is warranted for two (2) years after the date of purchase.

All warranty coverage extends only to the original purchaser of the product and is not assignable or transferable. The original store or online purchase receipt must be kept as proof of purchase in order for the warranty to be valid. These documents must be presented in the event of making a warranty claim.

During the warranty period, we will provide repair or replacement of defective equipment or parts thereof covered by the warranty. Any handling, transportation, delivery and other incidental charges in respect of the servicing of the equipment shall be borne by the Purchaser. If the product includes a number of accessories, only the defective part or accessory will be replaced.

The warranty will become void if any defects or damages are associated with the use of unauthorized replacement parts. All replacement parts must be obtained from our authorized agents.

All decisions made by the manufacturer in respect of the servicing of the equipment (including repairs, replacements or issues relating to defects of workmanship or materials) shall be conclusive and the Purchaser agrees to be bound by such decisions. Any defective equipment or part thereof replaced shall become the property of the manufacturer.

In the event of a product or accessory being replaced during the guarantee, the guarantee on the replacement will expire at the original date, i.e. 90 days from the original purchase date.

This warranty excludes defects caused by the product not being used in accordance with instructions, accidental damage, misuse or being tampered with by unauthorized persons.

The Limited Warranty does not cover:

- a) Products used for commercial or rental purposes.
- b) Loss or damage to product due to:
  - i. Abuse, repairs and/or tampering by any person other than the authorized personnel.
  - ii. Negligence and/or misuse (including foreign objects, accidents, improper storage, exposure to sun/moisture, excessive temperature, sand, dust, dirt, other pollution or other environmental conditions and failure to follow precautions or proper operating instructions stated in the User's Manual such as improper installations)
  - iii. Fire, flood, lightning strike, wind storm or other acts of God
  - iv. Freight or improper transport damages, and
  - v. Improper usage (including use by underage, overweight or excessive number of users permitted as stated in the User's Manual).
- c) Defects, damages or accidents due to the malfunction, connection to or use of unauthorized parts. In such event, we reserve the right to cancel the Limited Warranty coverage immediately.

To the extent allowed by the applicable local law, the remedies in the Limited Warranty are the Purchasers' sole and exclusive remedies.

THE MANUFACTURER IS NOT RESPONSIBLE OR LIABLE FOR INDIRECT, SPECIAL OR CONSEQUENTIAL DAMAGES ARISING OUT OF OR IN CONNECTION WITH THE USE OR PERFORMANCE OF THE PRODUCT OR OTHER DAMAGES WITH RESPECT TO ANY ECONOMIC LOSS, LOSS OF PROPERTY, LOSS OF REVENUE OR PROFITS, LOSS OF ENJOYMENT OR USE, COST OF REMOVAL, INSTALLATION OR OTHER CONSEQUENTIAL DAMAGES.

THE WARRANTY EXTENDED HEREUNDER IS IN LIEU OF ALL OTHER WARRANTIES AND ANY IMPLIED WARRANTY OF MERCHANTABILITY OR FITNESS FOR A PARTICULAR PURPOSE IS LIMITED IN ITS SCOPE AND DURATION TO THE TERMS SET FORTH HEREIN.

PLEASE NOTE: ANY REPAIRS OR REPLACEMENTS MUST BE MADE USING MANUFACTURER AUTHORIZED PARTS IN ORDER FOR THIS WARRANTY TO BE VALID.

DO NOT RETURN PRODUCT TO THE STORE. PLEASE CONTACT OUR CUSTOMER SERVICE FOR PARTS OR ASSEMBLY INSTRUCTIONS. STORES ARE NOT EQUIPPED TO PROVIDE CUSTOMER SERVICE FOR THIS PRODUCT.

OUR GOODS COME WITH GUARANTEES THAT CANNOT BE EXCLUDED UNDER THE AUSTRALIAN CONSUMER LAW. YOU ARE ENTITLED TO A REPLACEMENT OR REFUND FOR A MAJOR FAILURE AND COMPENSATION FOR ANY OTHER REASONABLY FORESEEABLE LOSS OR DAMAGE. YOU ARE ALSO ENTITLED TO HAVE THE GOODS REPAIRED OR REPLACED IF THE GOODS FAIL TO BE OF ACCEPTABLE QUALITY AND THE FAILURE DOES NOT AMOUNT TO A MAJOR FAILURE.

FOR NEW ZEALAND CUSTOMERS, THIS WARRANTY IS IN ADDITION TO STATUTORY RIGHTS OBSERVED UNDER NEW ZEALAND LEGISLATION.

**TASMAN SPORTS**

**SHEEHAN ROAD, WEST HEIDELBERG, VICTORIA**

**SERVICE PHONE NUMBER 1-800-333-061**

**MODEL NUMBER # TR-14C-PLX-01**

**KEYCODE: 41790038**