

# Clara Swivel Lounge Chair

## Instruction Manual

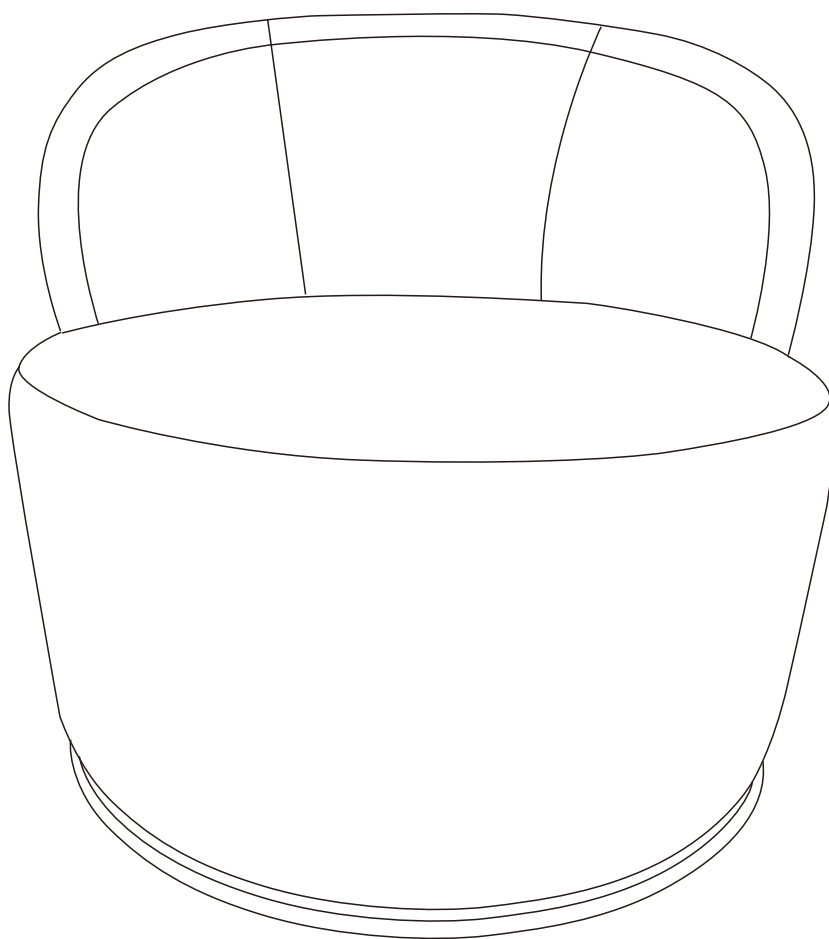

The photos and illustrations shown in this instruction manual are generic.  
The manufacturer reserves the right to change any specification or feature without prior notice.

**IMPORTANT: KEEP FOR FUTURE REFERENCE. READ CAREFULLY.**

# Assembly Instructions

## 43709632 Clara Swivel Lounge Chair

### **CARE INSTRUCTIONS:**

WIPE CLEAN WITH A SOFT DAMP CLOTH.

DO NOT USE ABRASIVE MATERIAL AND SOLVENTS.

SPOT CLEAN IF NEEDED.

KEEP AWAY FROM WATER AND DIRECT SUNLIGHT. STORE IN A DRY PLACE.

### **WARNING:**

DO NOT STAND ON THIS CHAIR.

DO NOT USE THIS CHAIR AS A STEP LADDER.

USE THIS PRODUCT FOR SEATING ONE PERSON AT A TIME.

DO NOT USE THIS CHAIR UNLESS ALL BOLTS AND SCREWS ARE FIRMLY SECURED.

DO NOT TIGHTEN THE SCREWS FULLY DURING ASSEMBLY, FULLY TIGHTEN SCREWS AFTER THE FINAL ASSEMBLY STEPS.

FOR INDOOR AND DOMESTIC USE ONLY.

FAILURE TO FOLLOW THESE WARNINGS COULD RESULT IN SERIOUS INJURY.

**MAXIMUM SAFE LOAD: 100KG.**

## 1 Hardware List

C		M6	1pc	D		M8x60MM	4pc	E		M8	4pc
F		M8	4pc								

## 2 Parts List

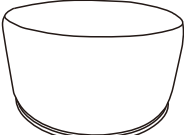
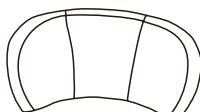
			
A	1PC	B	1PC

# PANEL LAYOUT

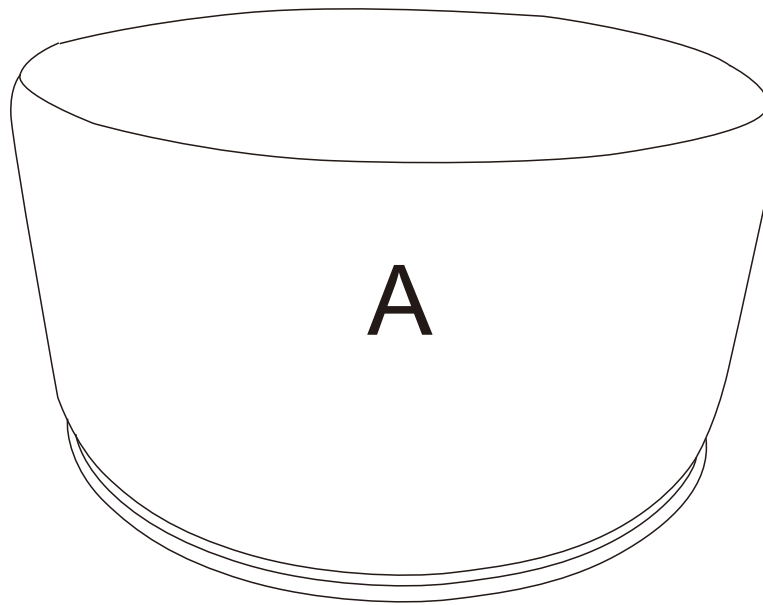
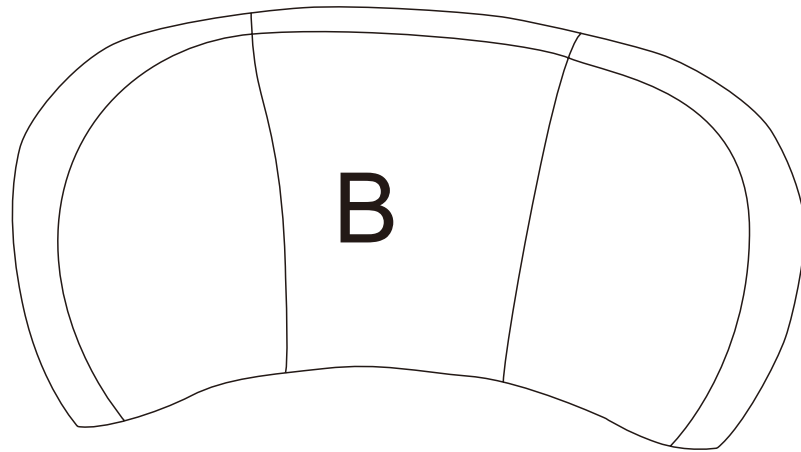

## STEP 1

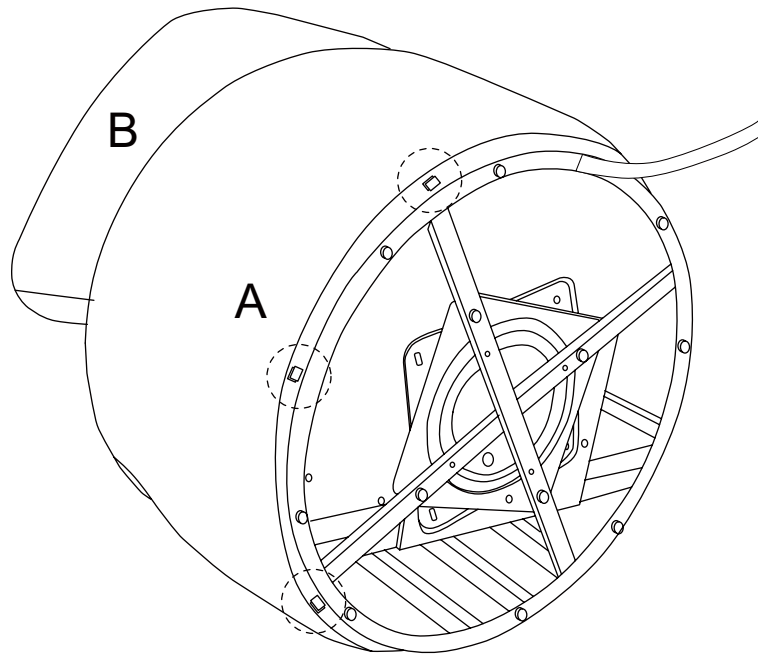

Before assembly, please remove the small wooden blocks and the non-woven fabric on the tube.

## STEP 2

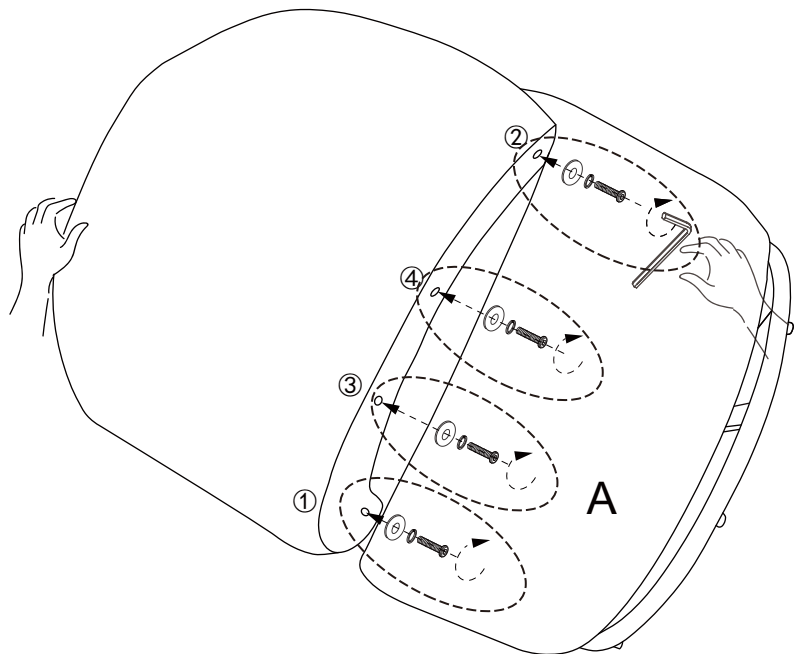
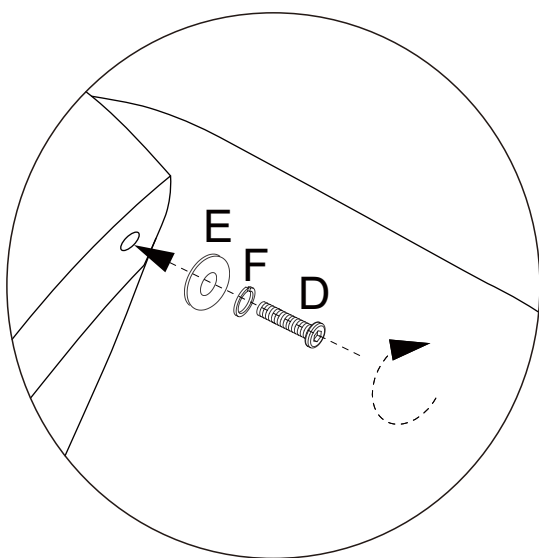

According to the order of the holes,  
twist each screw by a third.

**ATTENTION: DO NOT TURN THE BASE DURING ASSEMBLY.**

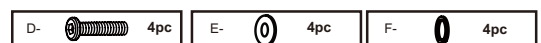

### STEP 3

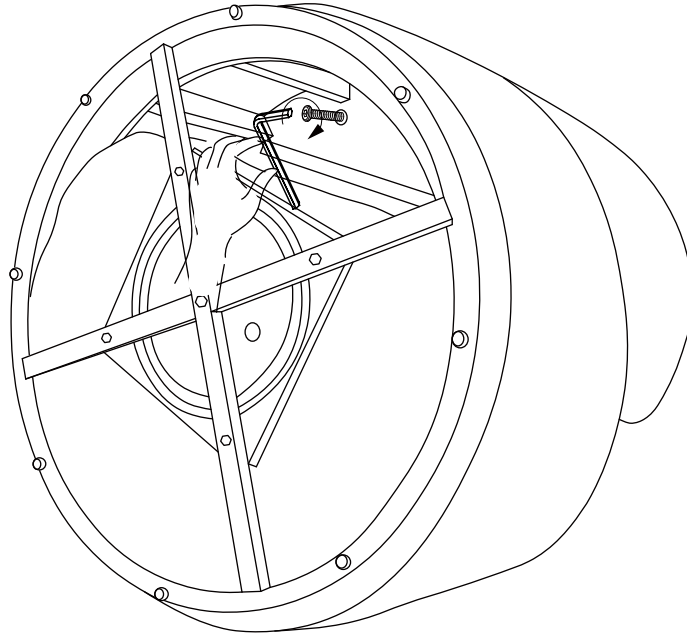

Turn the chair over and tighten the screws.

ATTENTION: DO NOT TURN THE BASE DURING ASSEMBLY.

### STEP 4

