

Assembly Instructions







43706556 CHLOE 1 DRAWER BEDSIDE BURGUNDY

CARE INSTRUCTION: Wipe clean with a soft dry or damp cloth. Keep away from water and direct sunlight. For indoor and domestic use. Check and tighten all parts regularly.

WARNINGS: Do not stand or sit on the unit. Do not lean on the product. Do not drag the product. Use only on a flat surface. Do not use until all screws, bolts and knobs are firmly secured. This product contains small parts and sharp points, keep away from children and babies. Adult assembly required. Failure to follow these warnings could result in serious injury.

MAXIMUM TOTAL LOADING WEIGHT: 5KGS FOR TOP PANEL AND SHELF, 2KGS FOR DRAWER, 12KGS IN TOTAL.

Hardware list

	a		4PCS
	b		1PC
	c		1PC
	d	4X12mm	1PC
	e	4X30mm	1PC
	f		2PCS

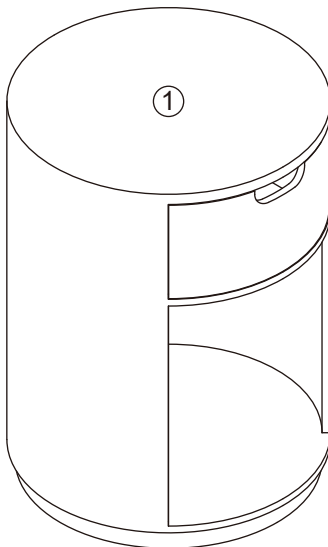
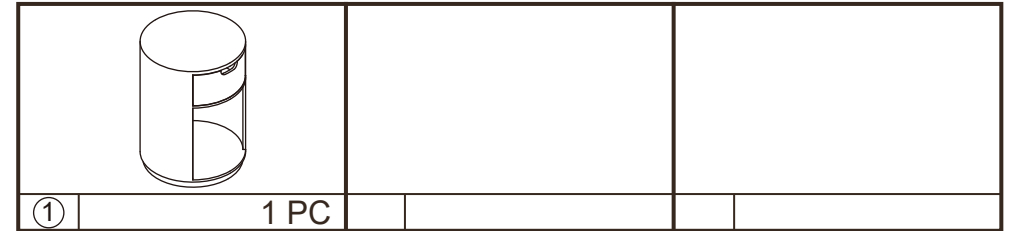

DO NOT TIGHTEN THE SCREWS UNTIL THE PRODUCT IS FULLY ASSEMBLED.

STEP 1



aX4

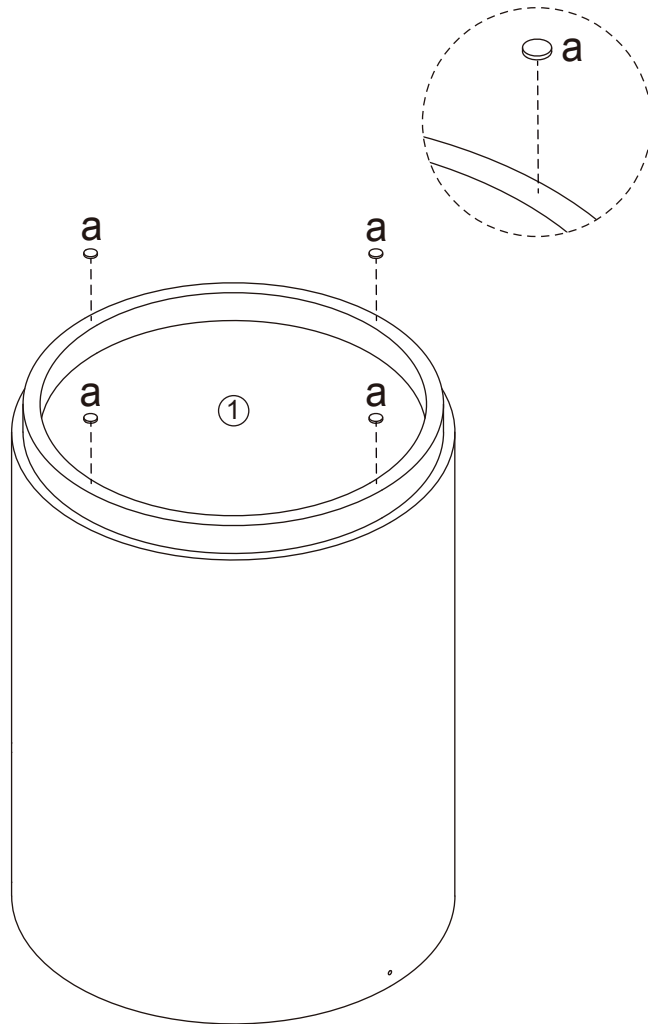

STEP 2



Warning:

- ALWAYS secure it with an anchor device.
- Please seek professional advice if you are in doubt of what fixing device to use.
- Regularly check that anchors are securely maintained.
- Use safety drawer locks to prevent children climbing.
- Stability of tall items may be affected by thick pile carpet or uneven floors.

• Do not place unanchored televisions on furniture.

Caution: for your safety when attaching the anchor fixings, please note the following:

- Check any electrical wires or plumbing inside the wall before drilling any holes (if you are unsure please seek professional advice from a qualified tradesperson)



TOPPLING HAZARD

WARNING: PLEASE SECURE YOUR FURNITURE WITH THE SUPPLIED WALL FIXING. SCAN THE CODE FOR MORE INFORMATION.



! WARNING

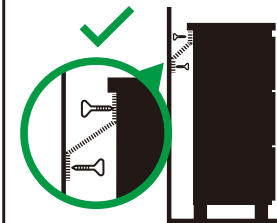

Children have died from furniture tipover.

- ALWAYS secure it with an anchor device.
- NEVER allow children to stand, climb or hang on drawers, doors, or shelves.
- NEVER open more than one drawer at a time.
- Place heavy items down low.
- Furniture type is at risk of toppling over.

NEVER put a TV on this furniture



This is a permanent label. Do not remove!

