

Willow Tall Cabinet with Shelves

Instruction Manual

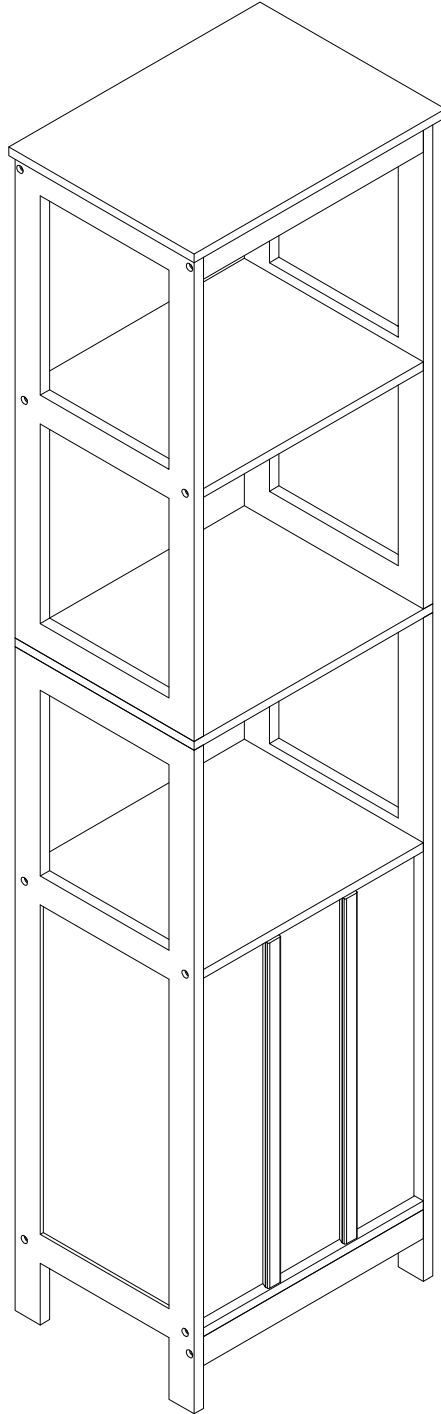

The photos and illustrations shown in this instruction manual are generic.
The manufacturer reserves the right to change any specification or feature without prior notice.

IMPORTANT: KEEP FOR FUTURE REFERENCE. READ CAREFULLY.

Assembly Instructions

K:43705450 | T:72593691 WILLOW TALL CABINET WITH SHELVES

WARNING:

DO NOT STAND, SIT OR LEAN ON THIS UNIT.

DO NOT USE THIS UNIT AS A STEP LADDER OR AS A CHOPPING SURFACE.

KEEP AWAY FROM CHILDREN AND BABIES.

ADULT ASSEMBLY REQUIRED.

USE ONLY ON A FLAT SURFACE.

DO NOT USE THIS UNIT UNLESS ALL BOLTS AND SCREWS ARE FIRMLY SECURED.

CARE INSTRUCTIONS:

TO BE ASSEMBLED ON A CLEAN, DRY AND SMOOTH SURFACE.

WIPE CLEAN WITH A SOFT DAMP CLOTH.

NEVER USE SCOURERS, ABRASIVES OR CHEMICAL SOLVENTS.

CHECK AND TIGHTEN ALL PARTS REGULARLY.

KEEP AWAY FROM MOISTURE AND DIRECT SUNLIGHT.



















STORE IN A DRY PLACE.

FOR INDOOR AND DOMESTIC USE ONLY.



MAXIMUM SAFE LOAD:

5kg FOR EACH SHELF

1 Hardware List

A		M6x35mm	4pcs	B		Ø15x9mm	4pcs	C		Ø6x30mm	26pcs	D		M4x35mm	15pcs
E			2pcs	F		M3x12mm	5pcs	G			4pcs	H		M3x16mm	4pcs
I			1pcs	J		M5x40mm	18pcs	K		M4x25mm	6pcs	L		Ø6x15mm	4pcs
M			1pcs	N		M3x14mm	2pcs	O			1pcs	P			4pcs
Q			1pcs	R		M4x12mm	1pcs	S			1pcs				

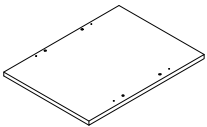
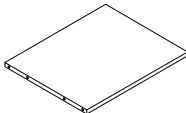
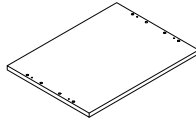
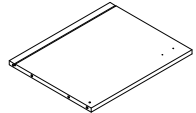
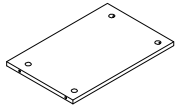
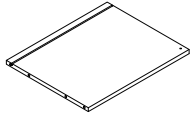
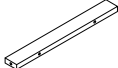
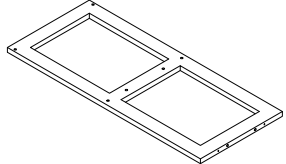
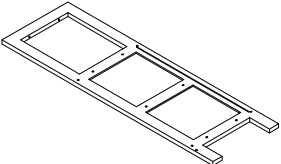
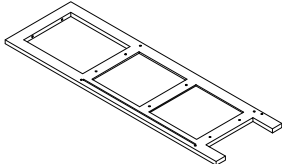
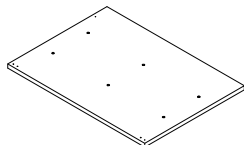
2 Parts List

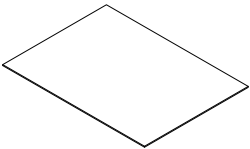
			
① 1PC	② 1PC	③ 1PC	④ 1PC
			
⑤ 1PC	⑥ 1PC	⑦ 3PCS	⑧ 2PCS
			
⑨ 1PC	⑩ 1PC	⑪ 1PC	⑫ 2PCS
			
⑬ 1PC			

PANEL LAYOUT

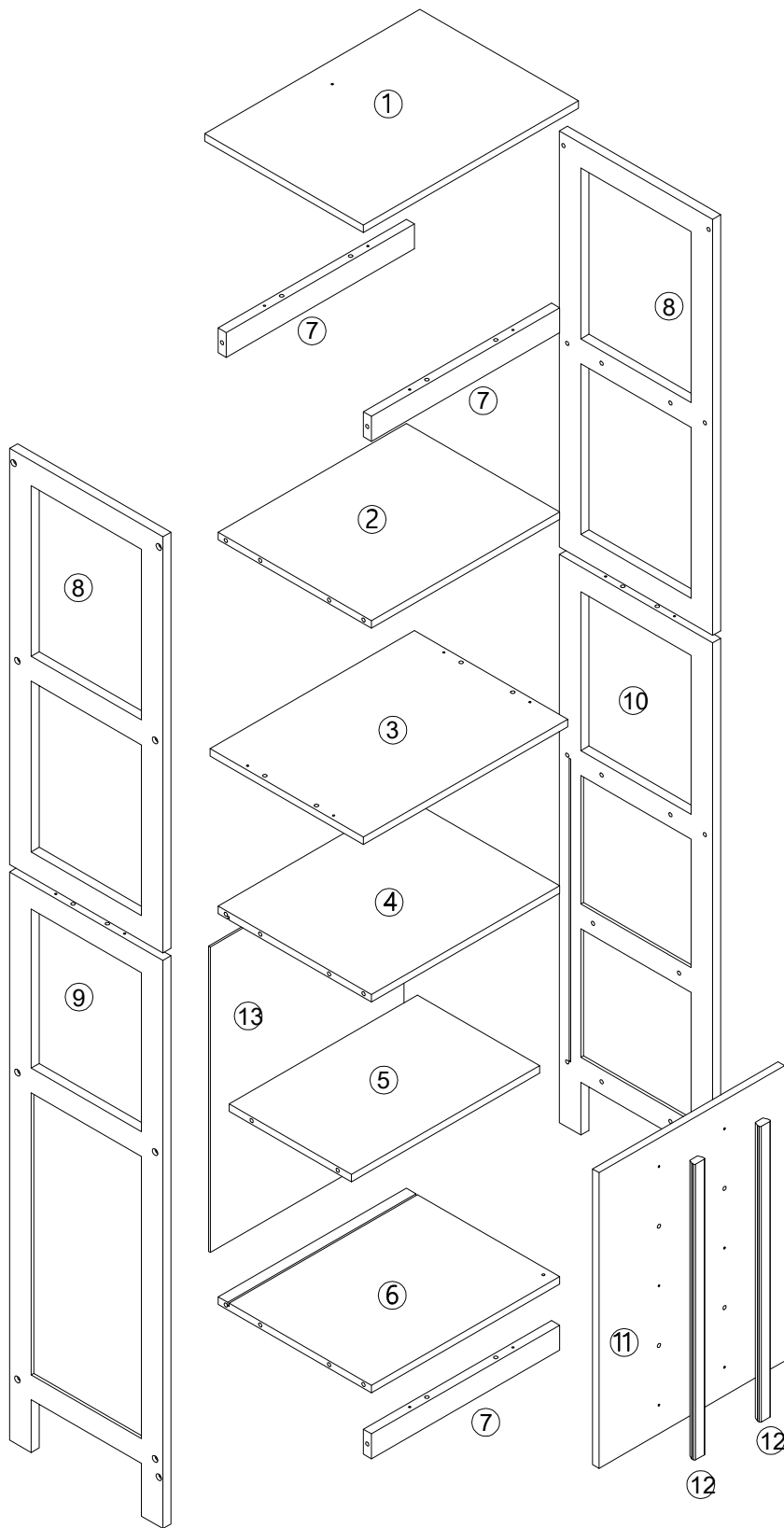

STEP 1

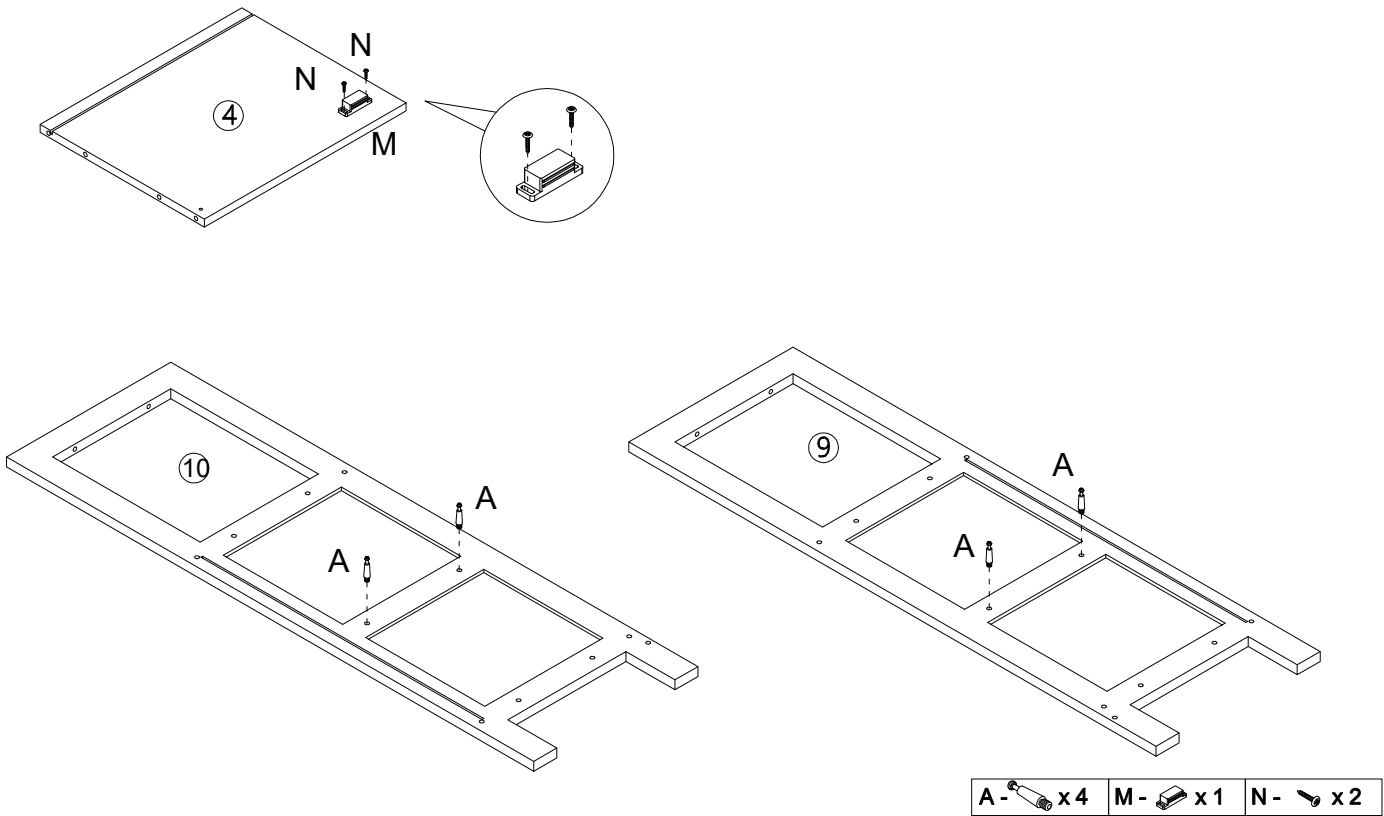

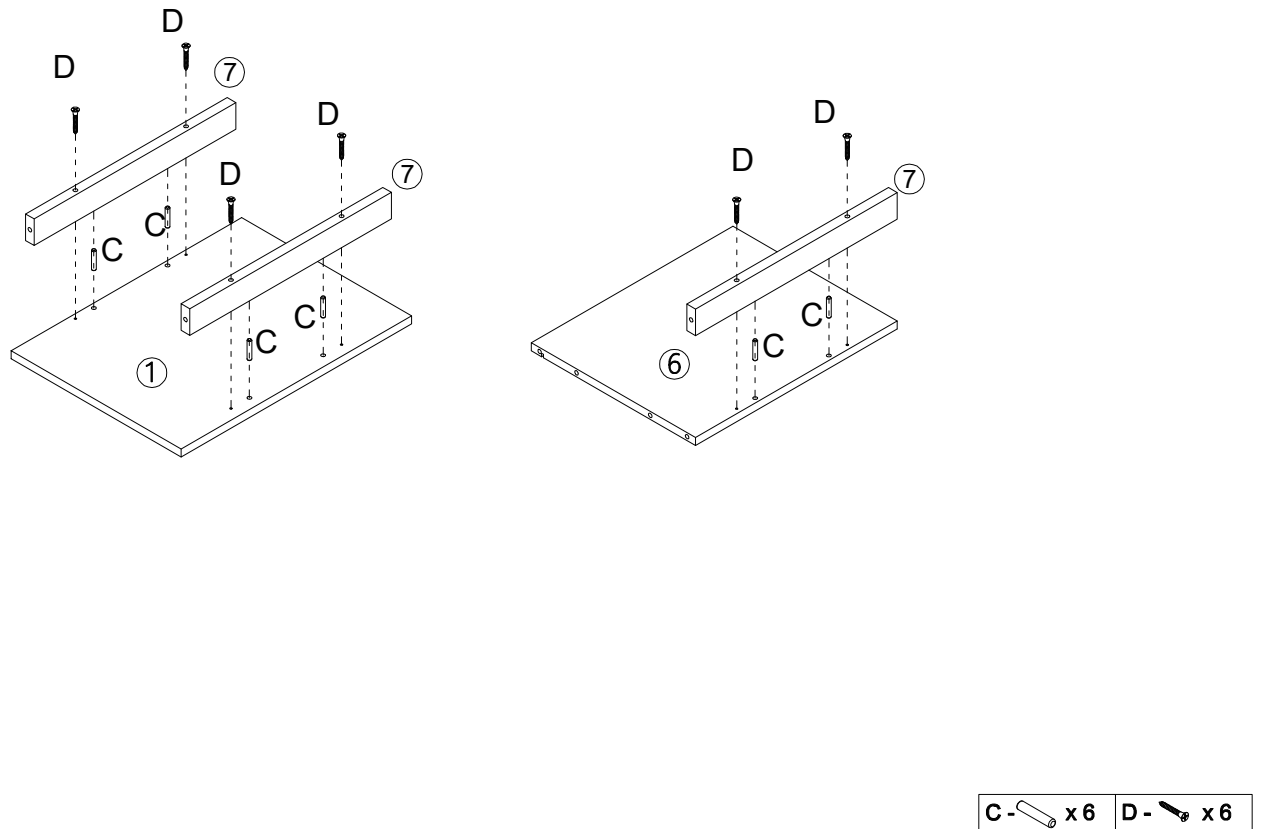

STEP 2



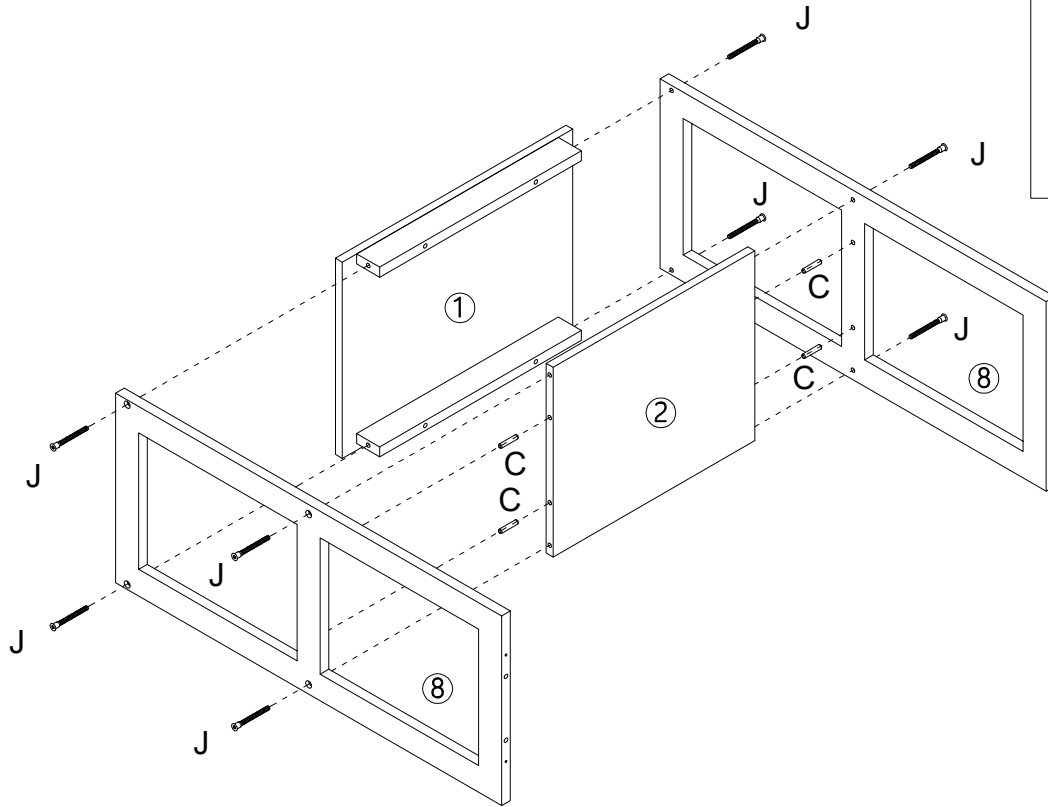

STEP 3

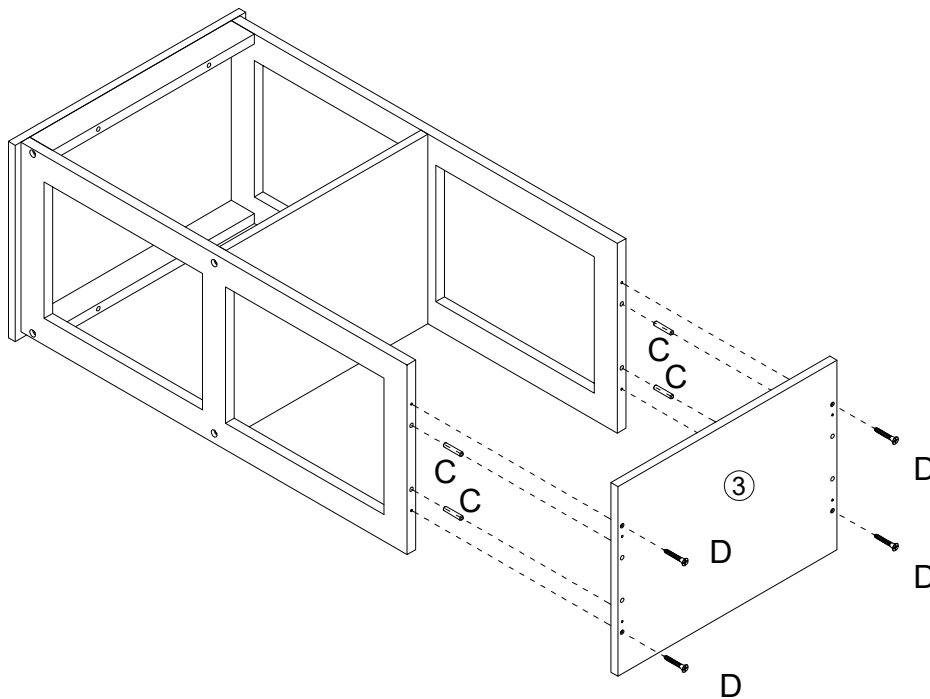

C-  x4 I-  x1 J-  x8

STEP 4



C-  x4 D-  x4

STEP 5

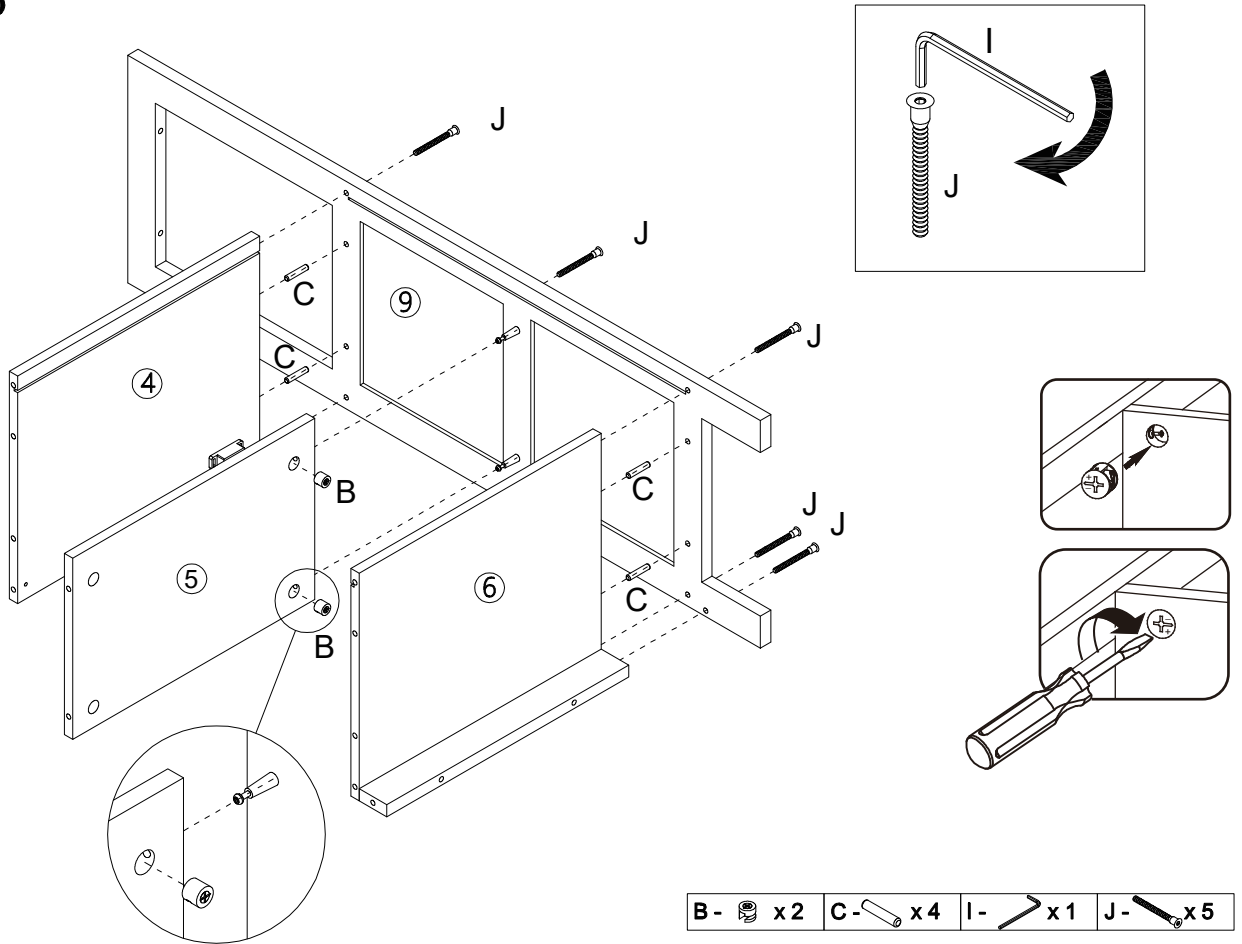

STEP 6

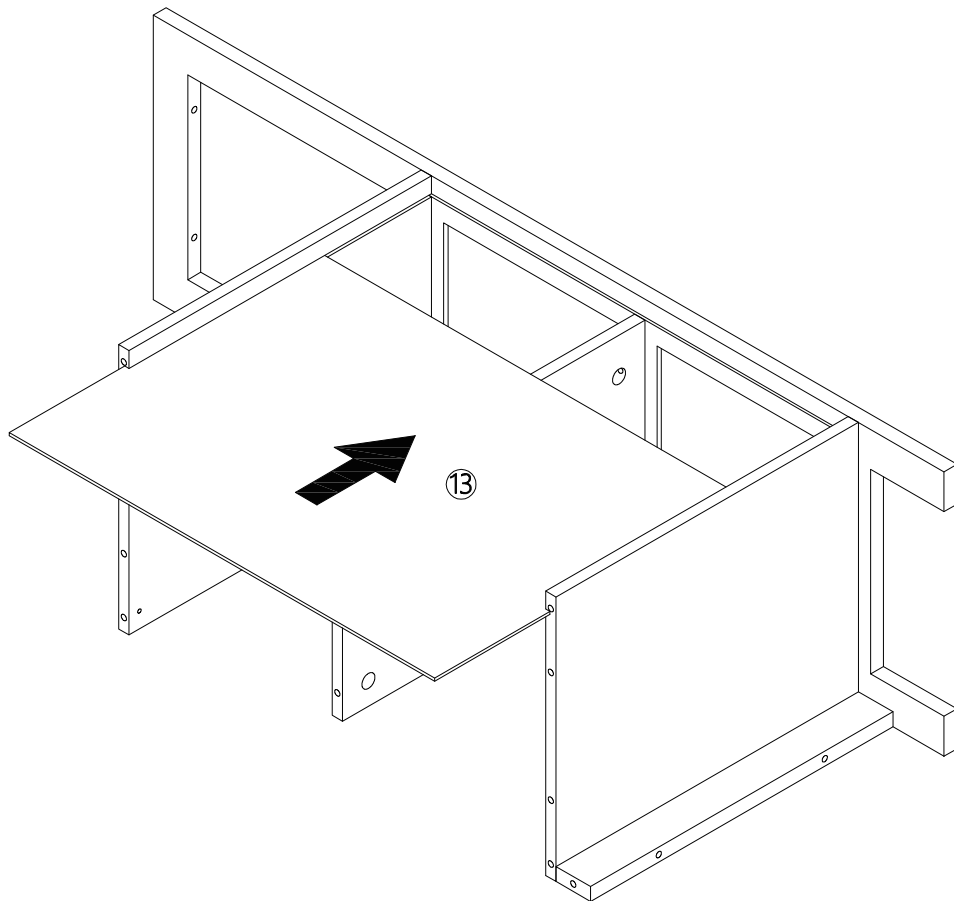

STEP 7

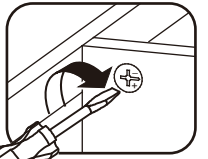
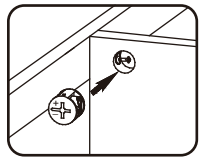
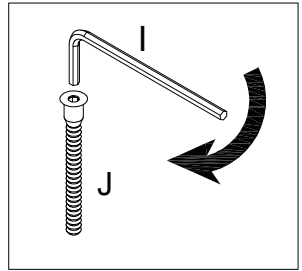
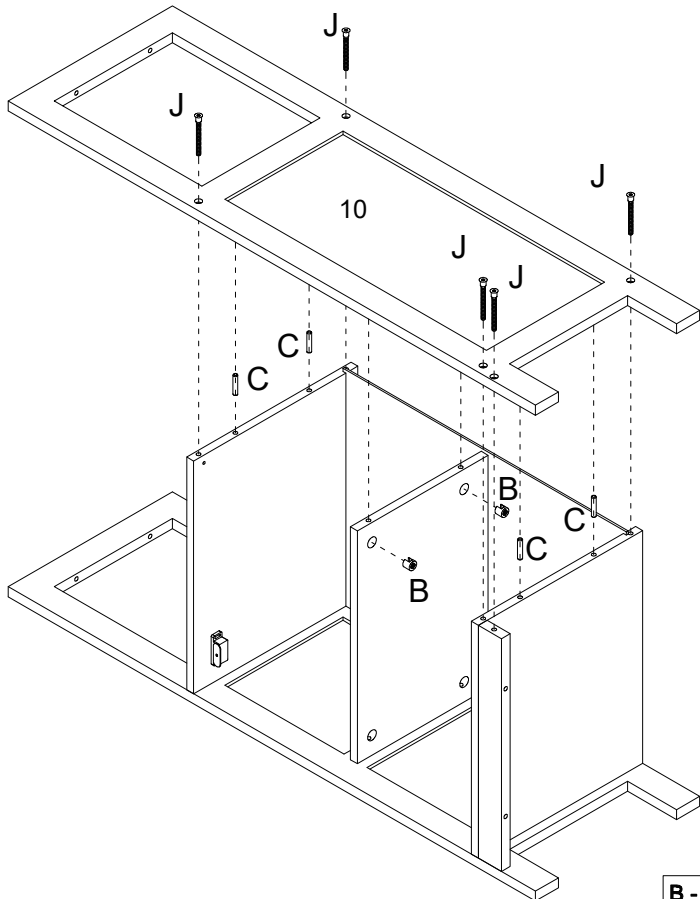

- B - x2
- C - x4
- I - x1
- J - x5



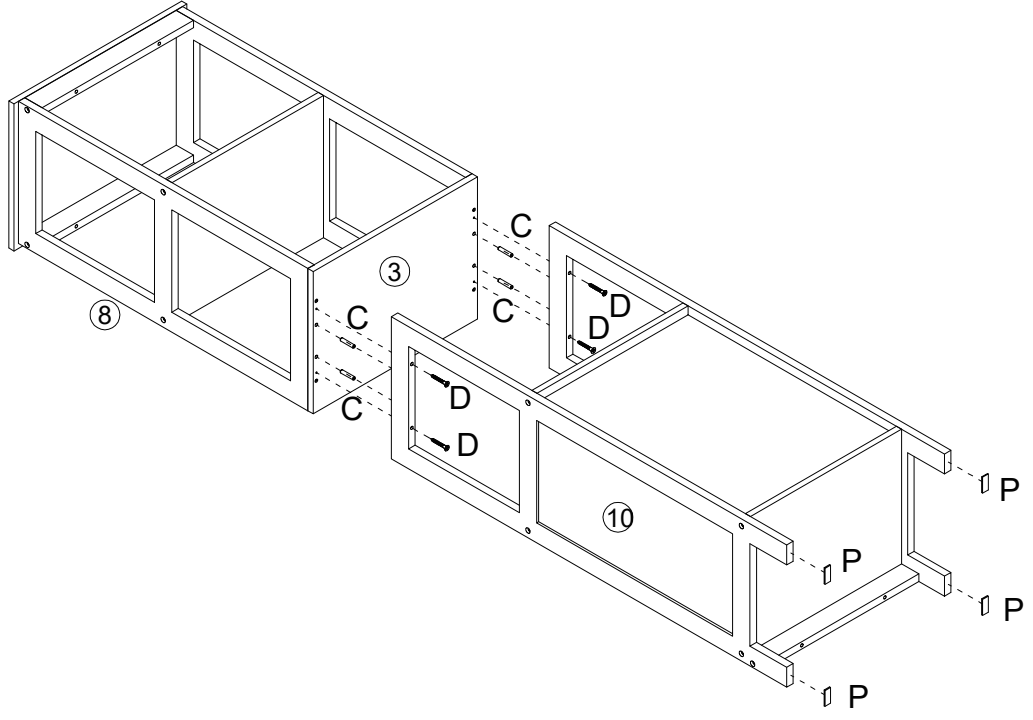

STEP 8

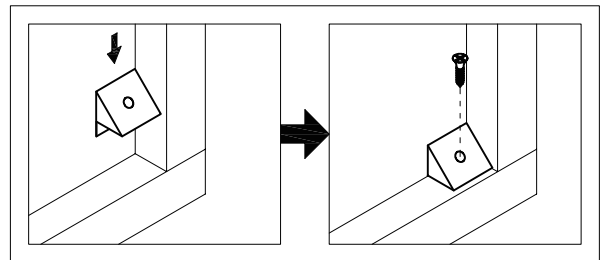
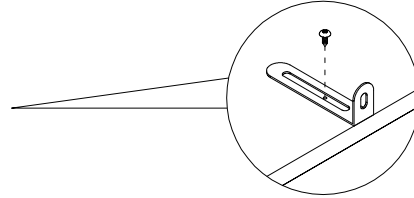
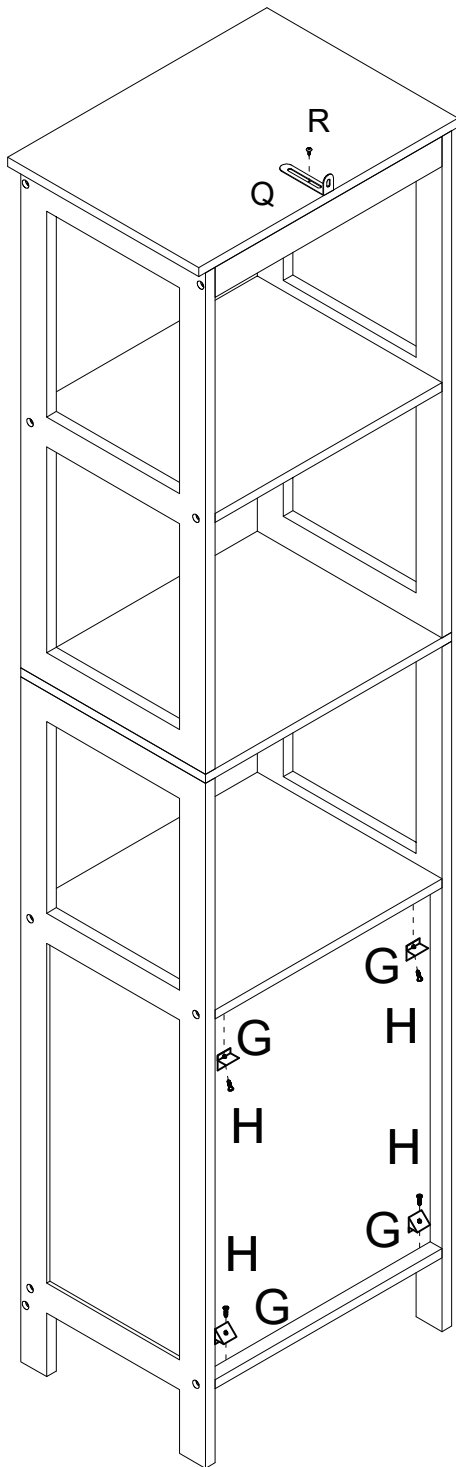

- C - x4
- D - x4
- P - x4



STEP 9



G-  x4 | H-  x4 | Q-  x1 | R-  x1

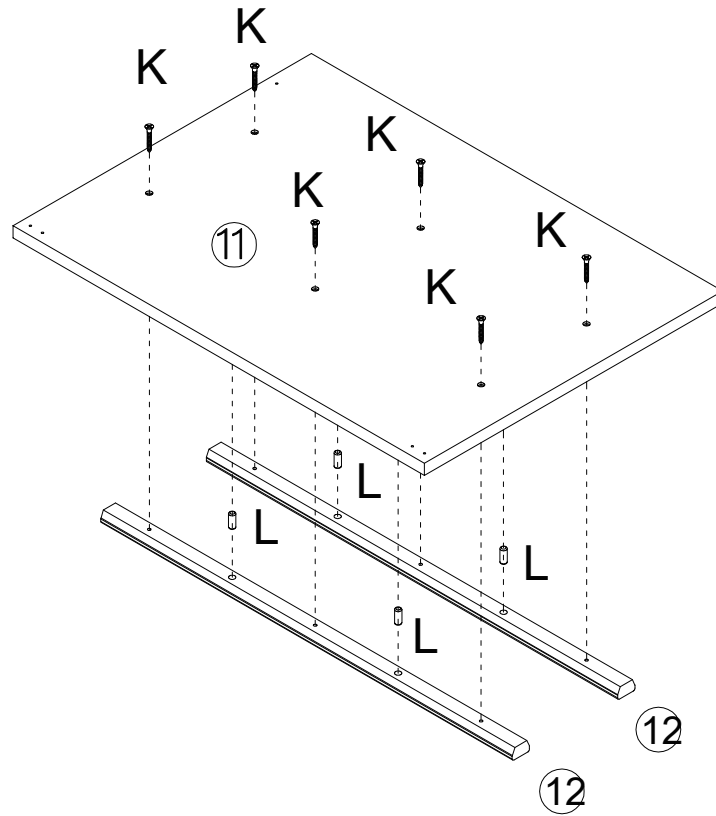

STEP 10

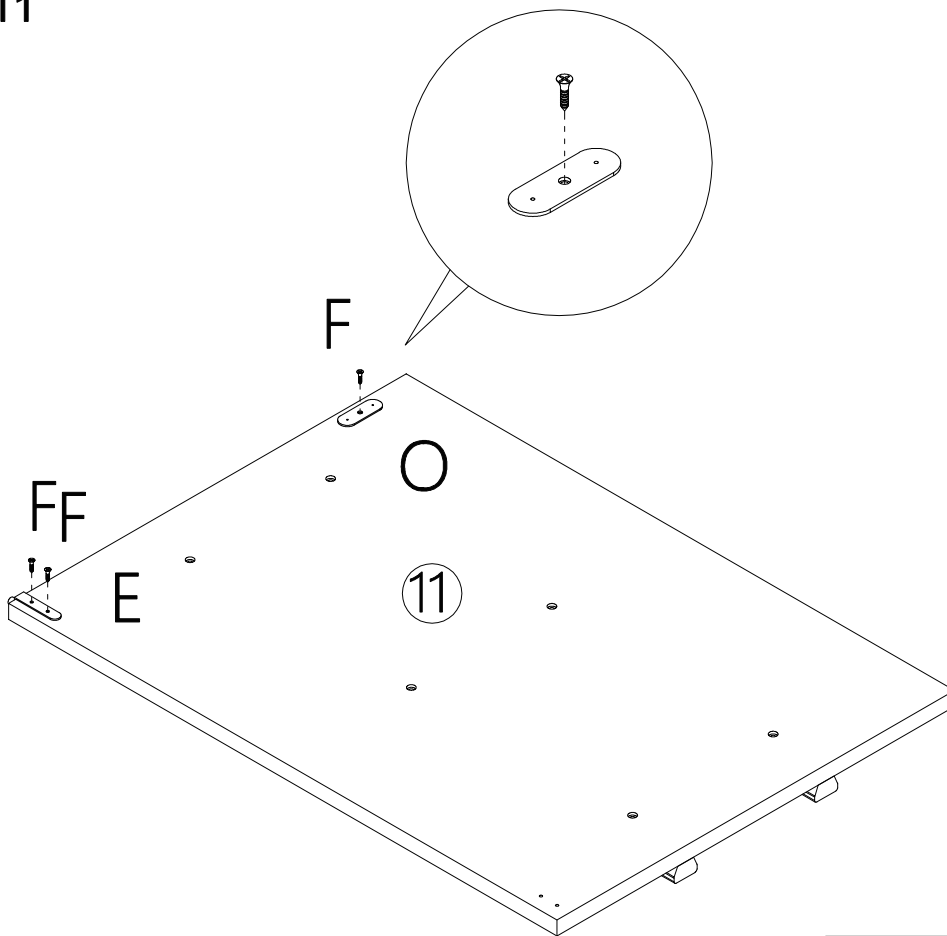

K-  x6 L-  x4

STEP 11



E-  x1 F-  x3 O-  x1

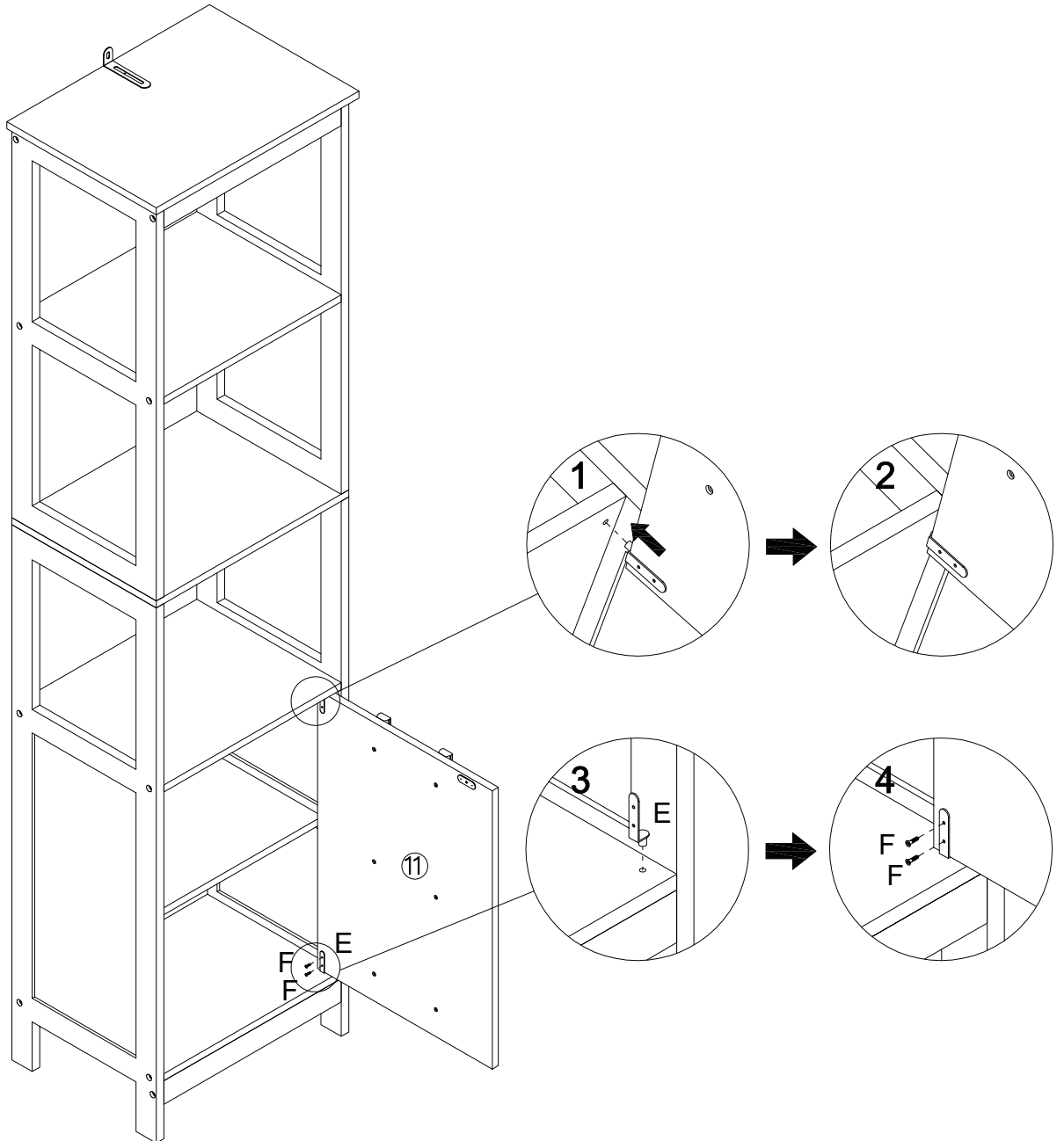

STEP 12

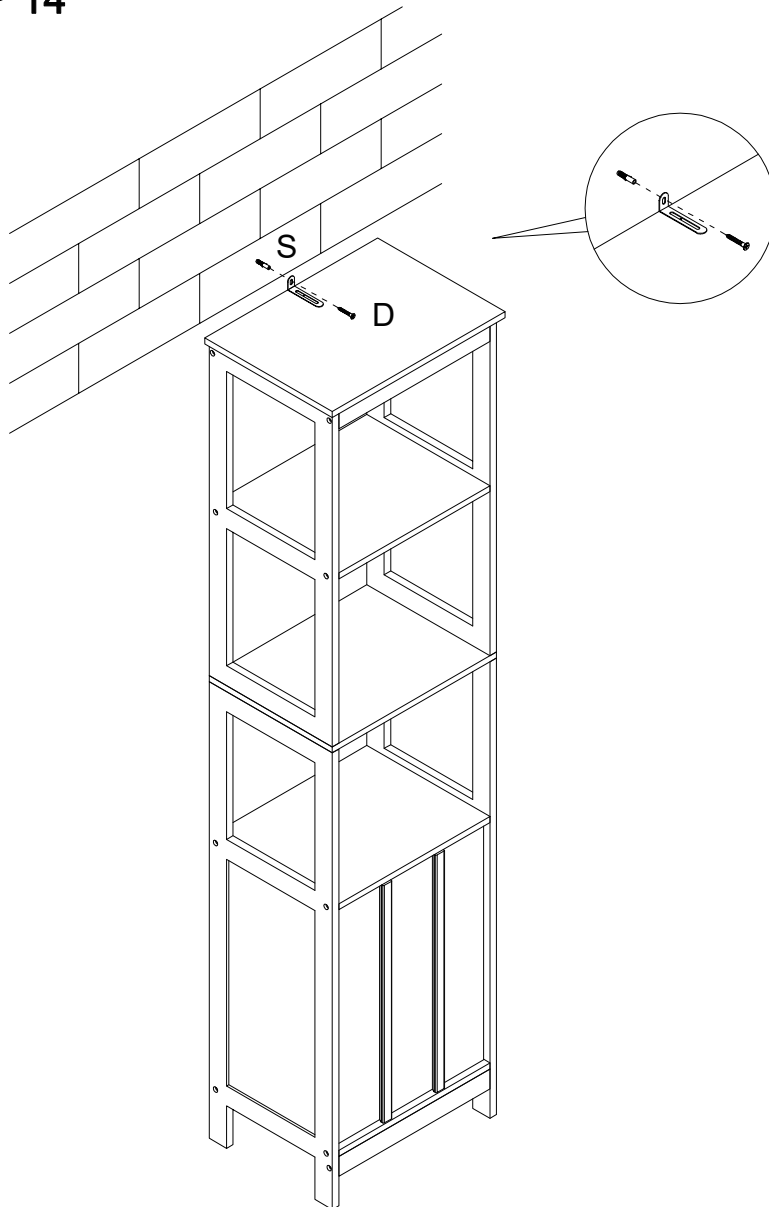

E-  x1 | F-  x2

STEP 14



D -  x1 S -  x1

⚠ WARNING



Children have died from furniture tipover.

- ALWAYS secure it with an anchor device.
- NEVER allow children to stand, climb or hang on drawers, doors, or shelves.
- NEVER open more than one drawer at a time.
- Place heavy items down low.

NEVER put a TV on this furniture 

This is a permanent label. Do not remove!

TOPPLING FURNITURE WARNING:

- ALWAYS secure it with an anchor device.
- Please seek professional advice if you are in doubt of what fixing device to use.
- Regularly check that anchors are securely maintained.
- Use safety drawer locks to prevent children climbing.
- Stability of tall items may be affected by thick pile carpet or uneven floors .
- Do not place unanchored televisions on furniture .

CAUTION: for your safety when attaching the anchor fixings, please note the following:

- Check any electrical wires or plumbing inside the wall before drilling any holes (if you are unsure please seek professional advice from a qualified tradesperson).



WARNING: PLEASE SECURE YOUR FURNITURE WITH THE SUPPLIED WALL FIXING. SCAN THE CODE FOR MORE INFORMATION.

