

Archie Dining Chair

Instruction Manual

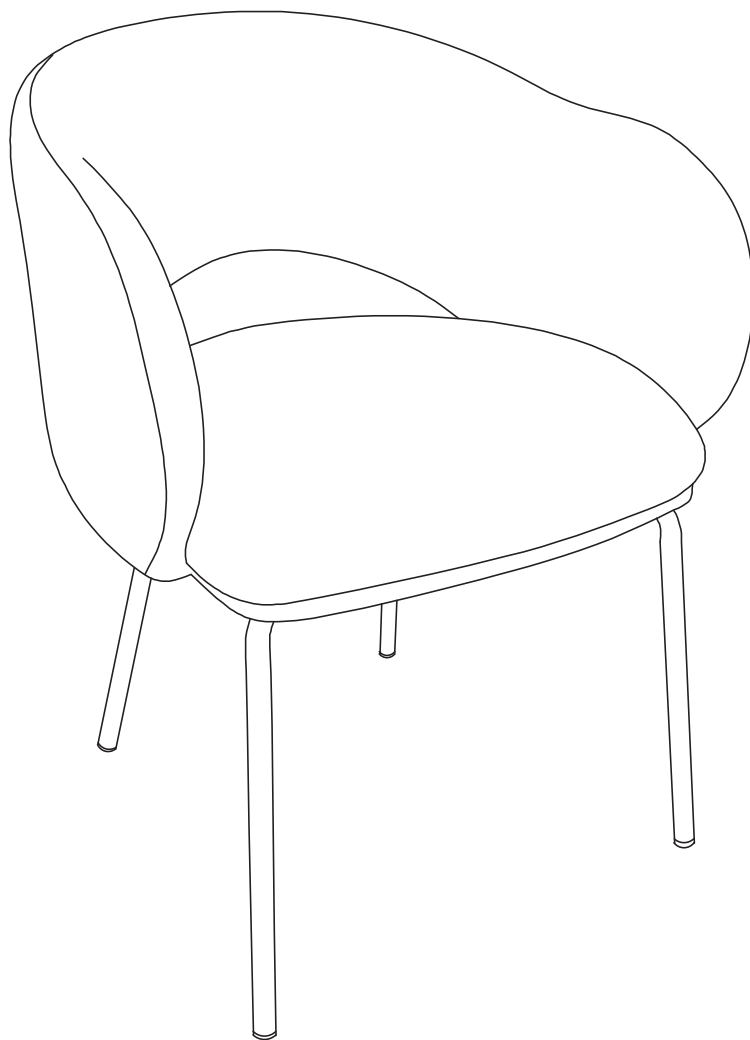

The photos and illustrations shown in this instruction manual are generic.
The manufacturer reserves the right to change any specification or feature without prior notice.

IMPORTANT: KEEP FOR FUTURE REFERENCE. READ CAREFULLY.

Assembly Instructions

43702336/43702381 Archie Dining Chair

CARE INSTRUCTIONS:

WIPE CLEAN WITH A SOFT DAMP CLOTH.

DO NOT USE ABRASIVE MATERIALS AND SOLVENTS.

SPOT CLEAN IF NEEDED.

KEEP AWAY FROM WATER AND DIRECT SUNLIGHT.

STORE IN A DRY PLACE.

WARNING:

DO NOT STAND ON THIS CHAIR.

USE ONLY ON A FLAT SURFACE.

SUITABLE FOR ONE PERSON USE ONLY.

DO NOT USE UNTIL ALL SCREWS, BOLTS AND KNOBS ARE FIRMLY SECURED.

THIS PRODUCT CONTAINS SMALL PARTS AND SHARP POINTS. KEEP AWAY FROM CHILDREN AND BABIES.

ADULT ASSEMBLY REQUIRED.



DO NOT TIGHTEN THE SCREWS FULLY DURING ASSEMBLY, FULLY TIGHTEN SCREWS AFTER THE FINAL ASSEMBLY STEPS.

FAILURE TO FOLLOW THESE WARNINGS COULD RESULT IN SERIOUS INJURY. CHECK AND TIGHTEN ALL PARTS REGULARLY.

FOR INDOOR AND DOMESTIC USE ONLY.

MAXIMUM SAFE LOAD:100KG

1 Hardware List

A		M6x18mm	9pcs	B		M6* ϕ 18*1.5mm	9pcs
C		M4	1pc				

2 Parts List

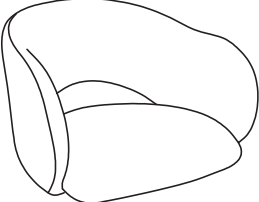
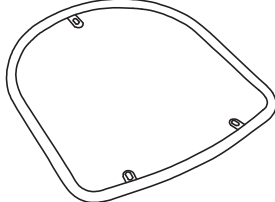
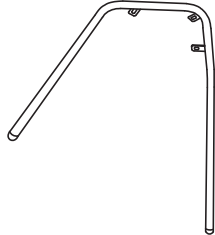
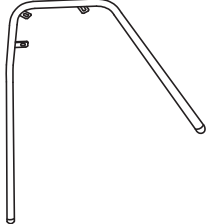

			
①	②	③	④
1PC	1PC	1PC	1PC

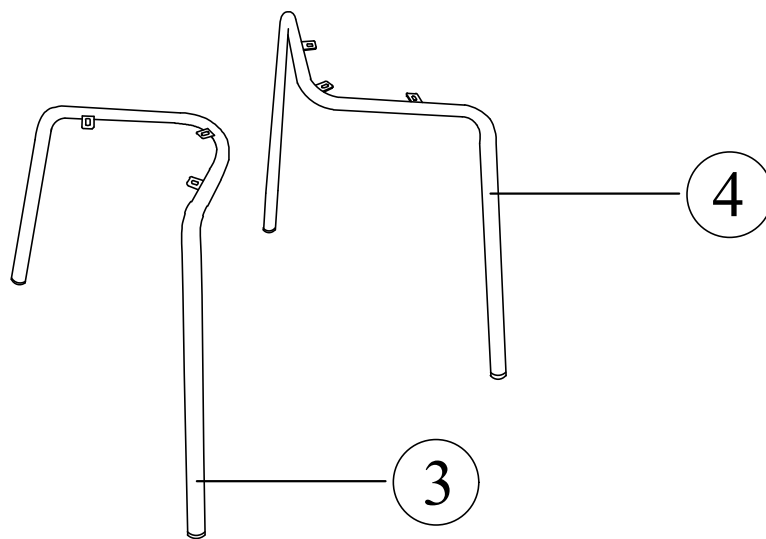
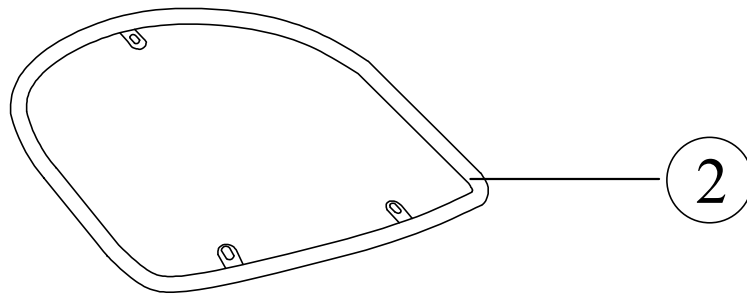
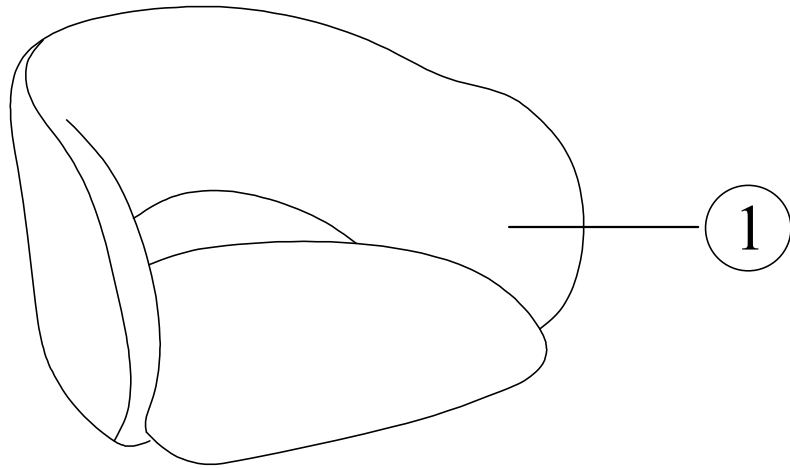
PANEL LAYOUT



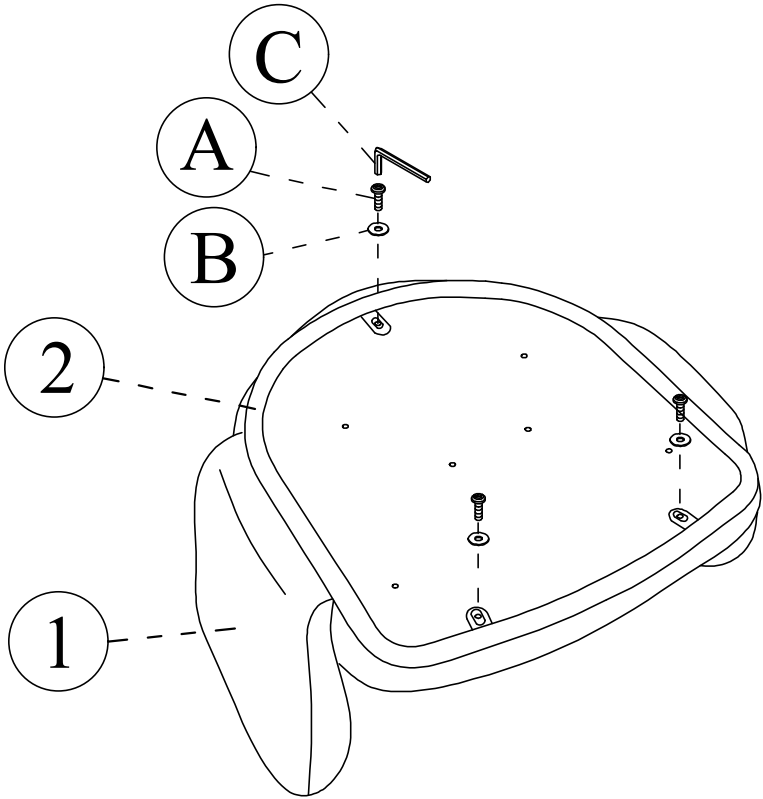



STEP-1

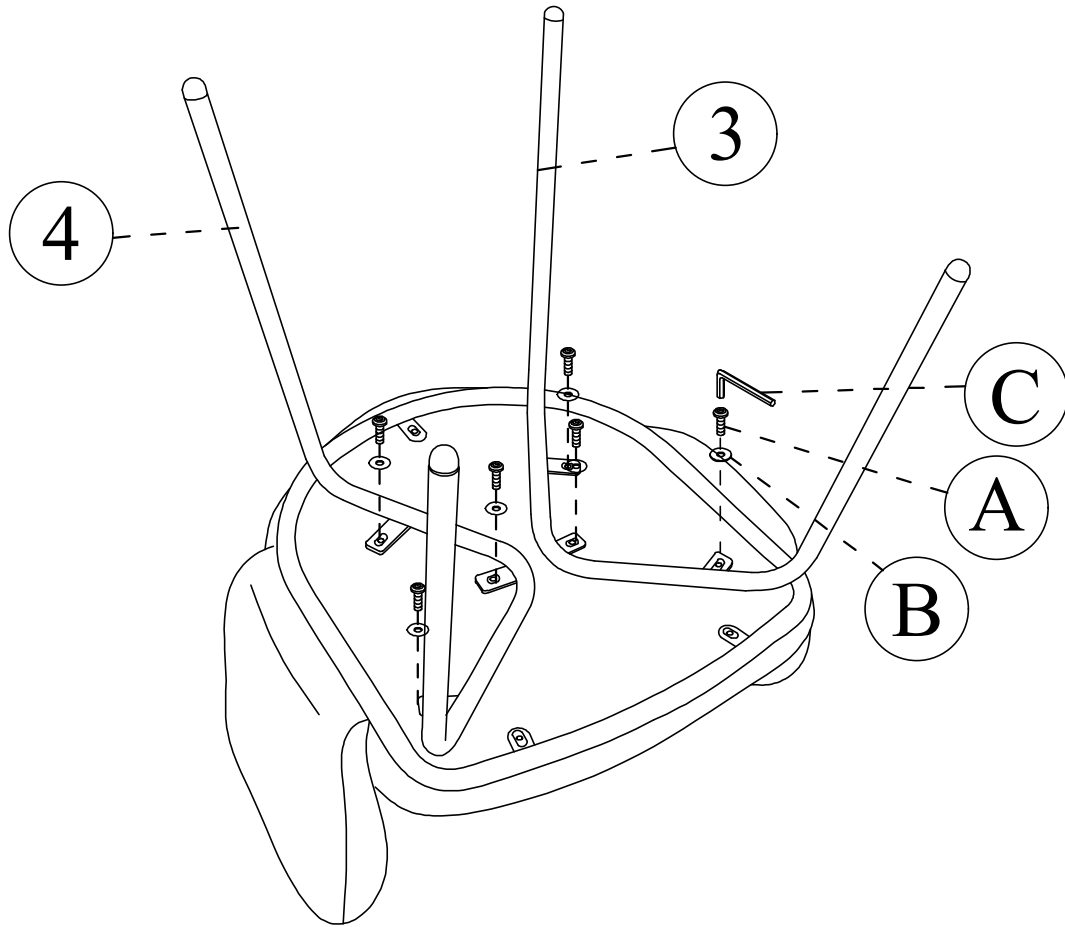

A-  x3	B-  x3
C-  x1	

STEP-2



A-  x6	B-  x6
C-  x1	

