

Arlo Upholstered Bed/ Jax Bedframe/ Mali Bedframe Instruction Manual

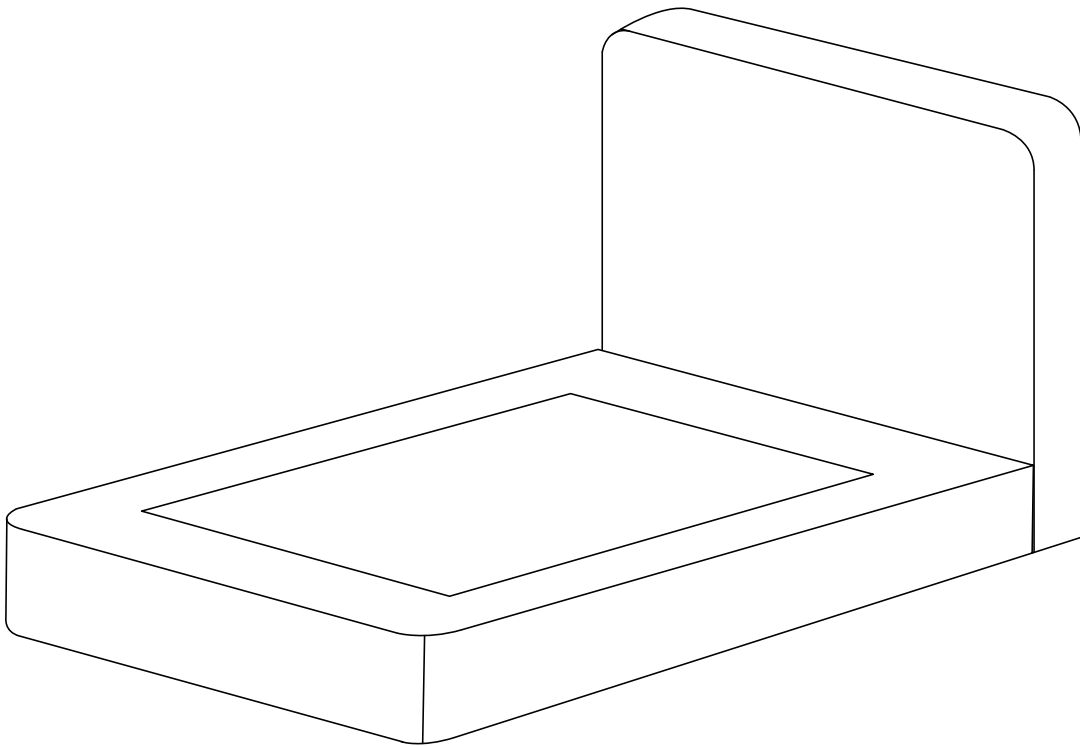

The photos and illustrations shown in this instruction manual are generic.
The manufacturer reserves the right to change any specification or feature without prior notice.

IMPORTANT: KEEP FOR FUTURE REFERENCE. READ CAREFULLY.

Assembly Instructions

43682713 Arlo Upholstered Bed
43712151 Jax Bedframe
43701414 Mali Bedframe

CARE INSTRUCTIONS:

WIPE CLEAN WITH A DRY CLOTH.

DO NOT USE ABRASIVE MATERIALS AND SOLVENTS.

SPOT CLEAN IF NEEDED.

KEEP AWAY FROM WATER AND DIRECT SUNLIGHT.

WARNING:

ALWAYS USE THE CORRECTLY SIZE MATTRESSES OR MATTRESS SUPPORTS, OR BOTH, TO HELP PREVENT THE LIKELIHOOD OF ENTRAPMENT OR FALLS.

DO NOT ALLOW HORSEPLAY ON OR UNDER THE BED AND PROHIBIT JUMPING ON THE BED.

THE USE OF WATER OR SLEEP FLOTATION MATTRESSES IS PROHIBITED.

DO NOT STAND ON THE BEDHEAD SURFACE.

DO NOT USE UNTIL ALL SCREWS AND BOLTS ARE FIRMLY SECURED.

THIS PRODUCT CONTAINS SMALL PARTS AND SHARP POINTS, KEEP AWAY FROM CHILDREN AND BABIES.

ADULT ASSEMBLY REQUIRED.

DO NOT TIGHTEN THE SCREWS FULLY DURING ASSEMBLY.



FULLY TIGHTEN SCREWS AFTER THE FINAL ASSEMBLY STEPS. CHECK AND TIGHTEN ALL PARTS REGULARLY.

FOR INDOOR AND DOMESTIC USE.









FAILURE TO FOLLOW THESE WARNINGS COULD RESULT IN SERIOUS INJURY.

MAXIMUM SAFE LOAD: 400KGS

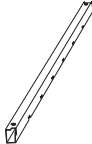
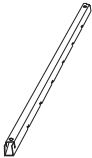
1 Hardware List

A		M6x14mm	18pcs	B		M6	1pc
---	---	---------	-------	---	--	----	-----

2 Parts List

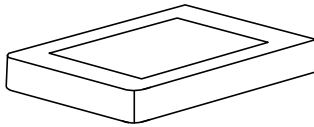
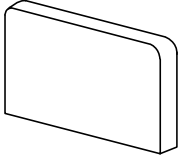
			
① 2PCS	② 2PCS	③ 2PCS	④ 2PCS
			
⑤ 2PCS	⑦ 2PCS	⑧ 2PCS	⑪ 5PCS
			
⑫ 2PCS	⑬ 24PCS	⑭ 1PC	⑮ 1PC

PANEL LAYOUT

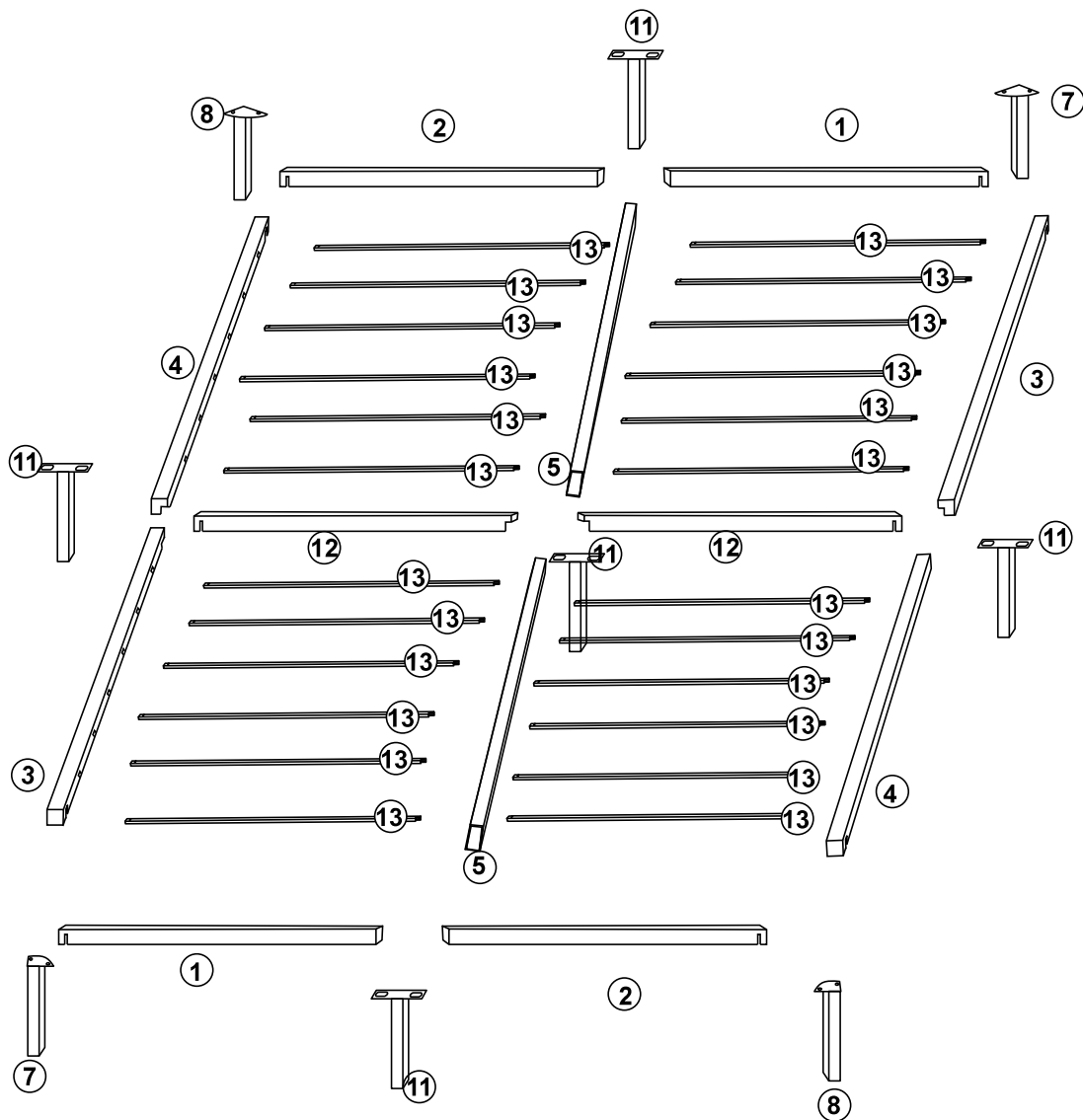
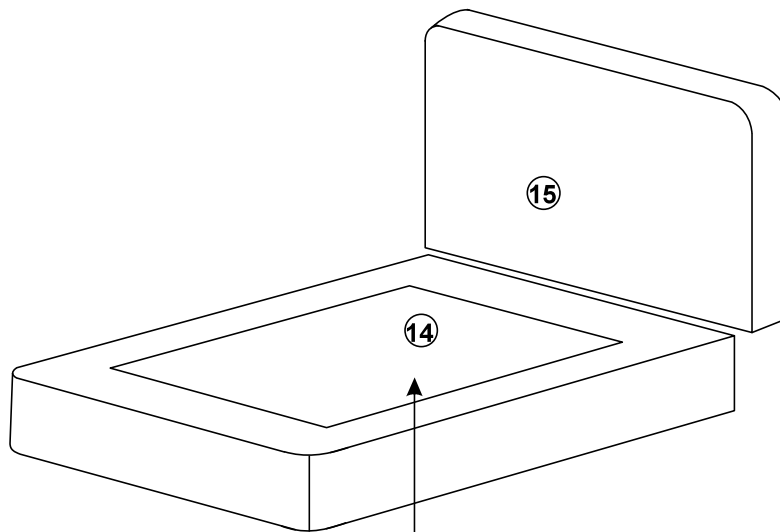

Opening method of the headboard and bed surround edges

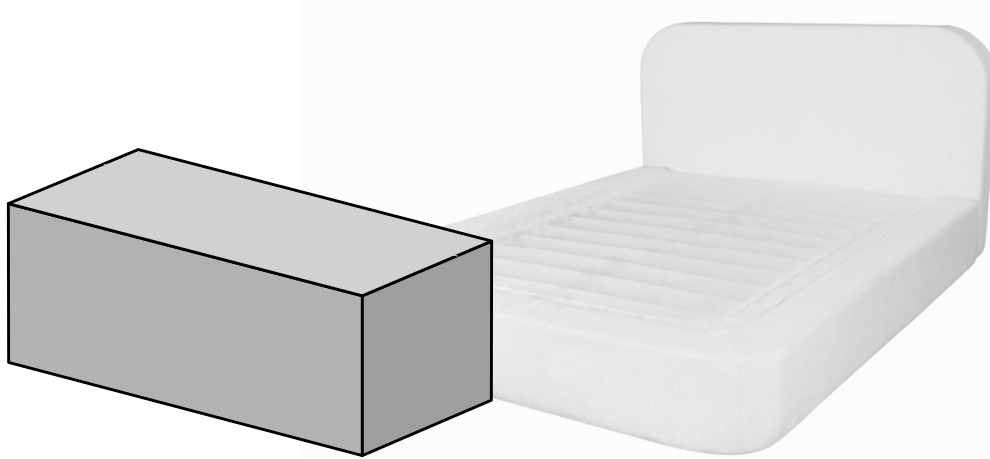

ATTENTION: AS THIS PRODUCT IS VACUUM COMPRESSED, ALLOW UP TO 72 HOURS FOR THE PRODUCT TO FULLY REGAIN ITS ORIGINAL SHAPE.

STEP 1: Unbox

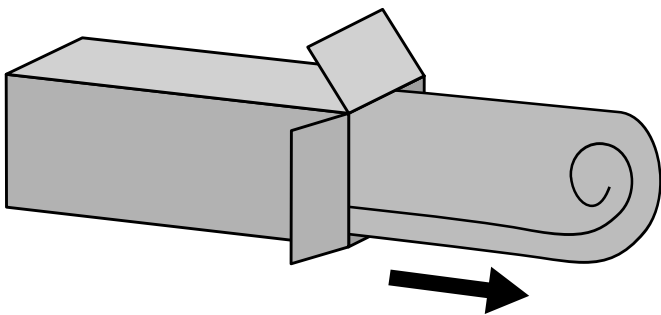

Open the box and take out the product.

STEP 2: Unroll

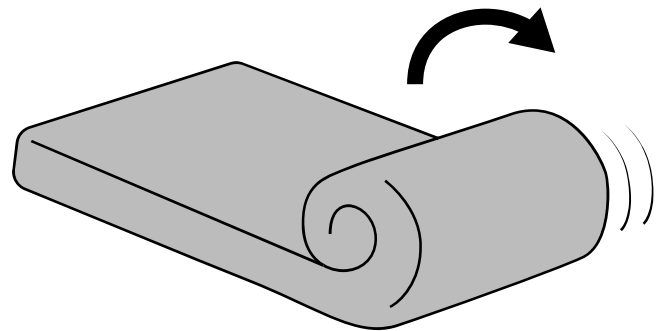

Place the product headboard and bed surround edges on the floor and unroll from the red line.

STEP 3: Unwrap

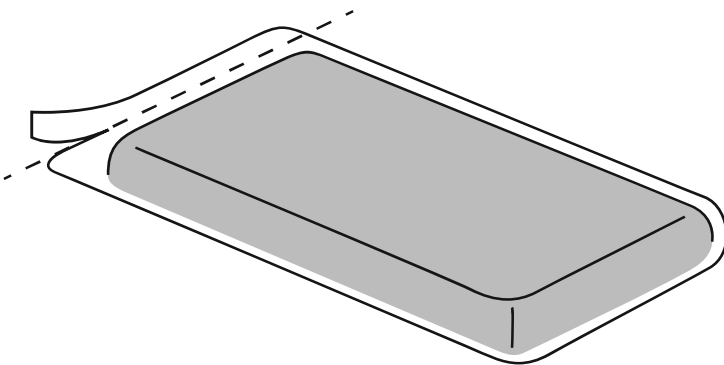

Remove the plastic bag and avoid using sharp tools or knives to puncture the wound.

STEP 4: Expand

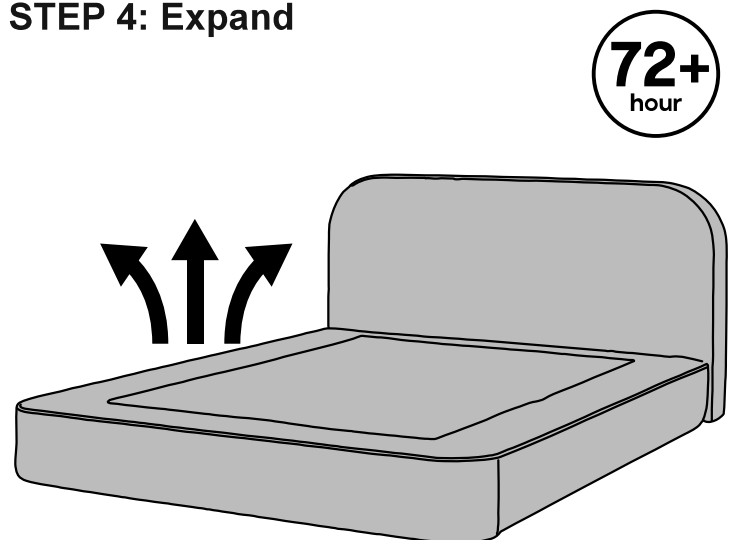

After opening the plastic bag, the sofa will immediately partially rebound. It will basically complete its rebound After 72 hours.

STEP 1

Assembly method of the bed frame

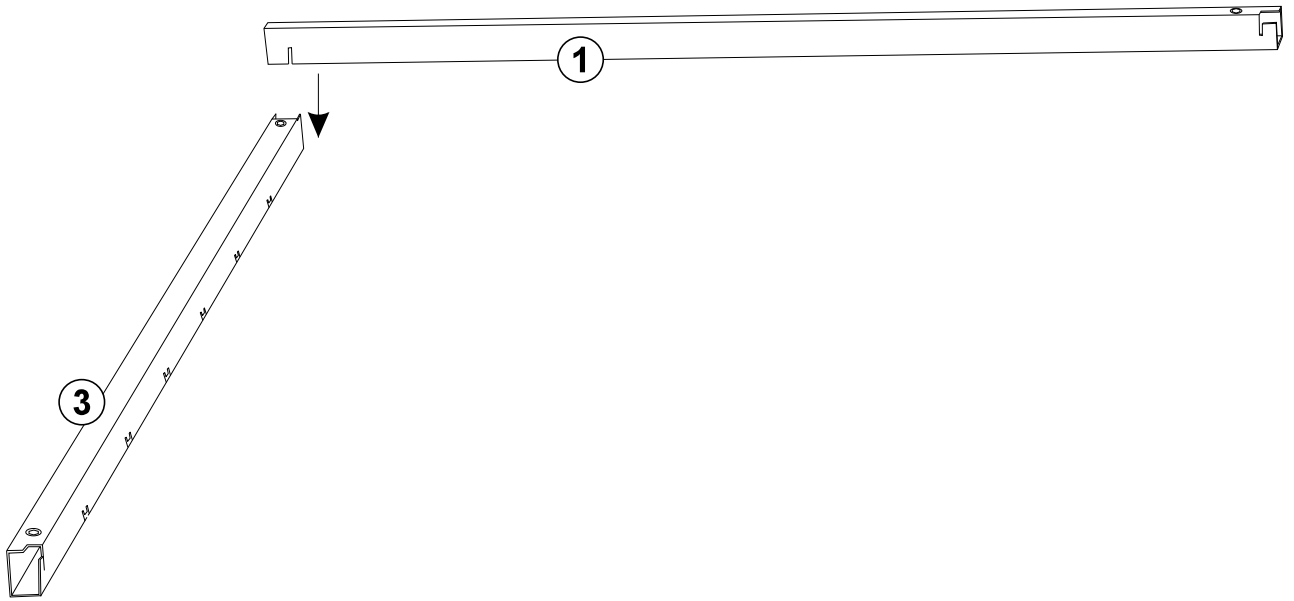

x2

STEP 2

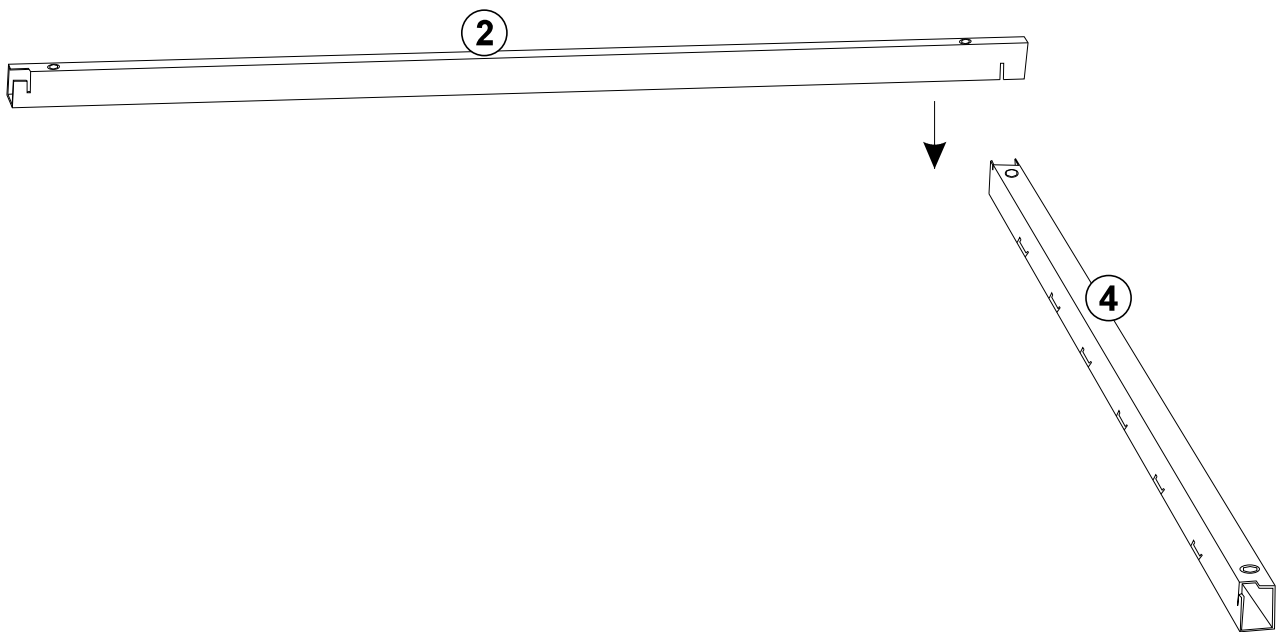

x2

STEP 3

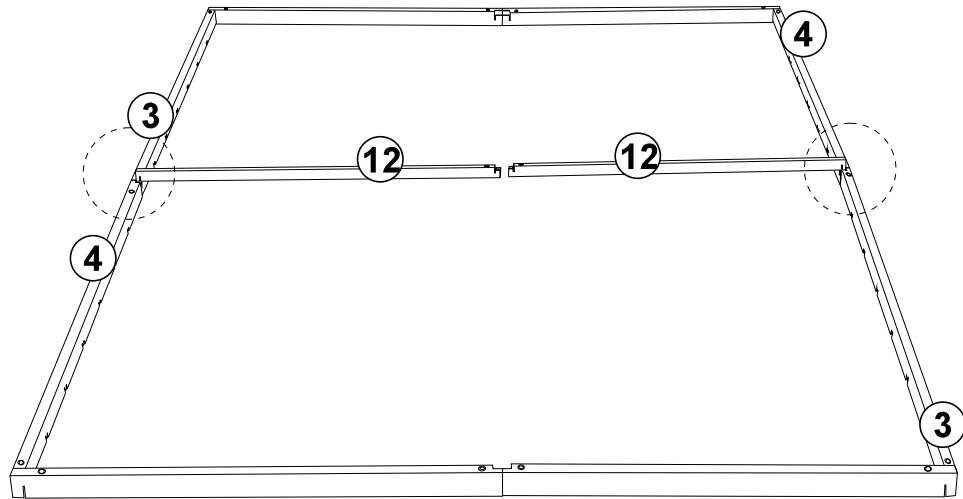
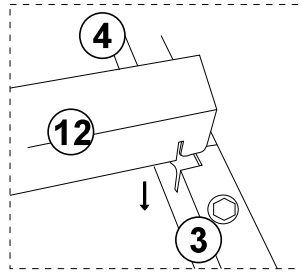

STEP 4

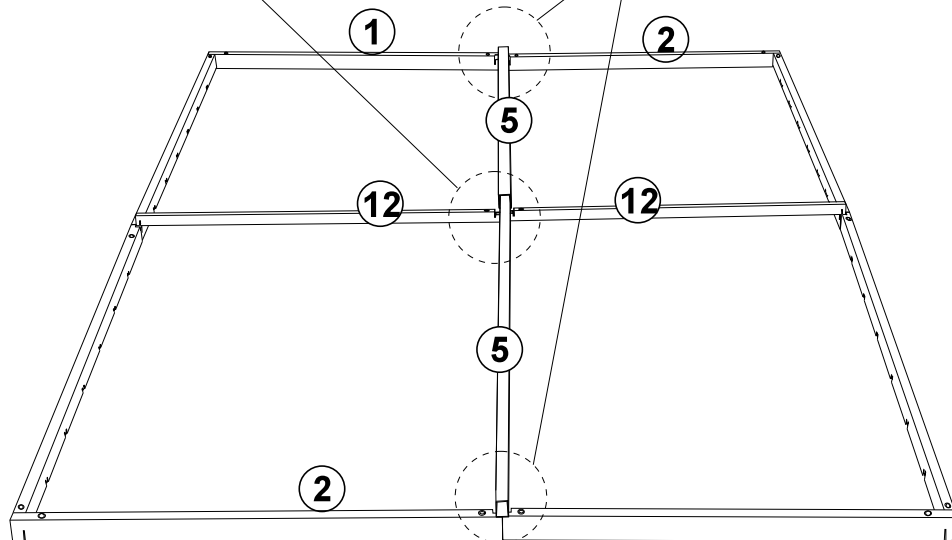
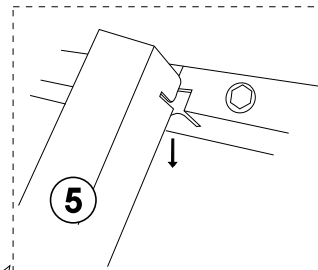
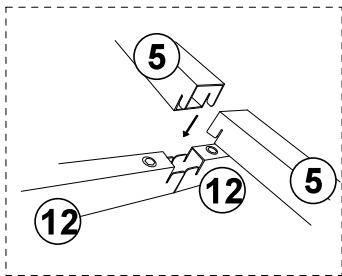

STEP 5

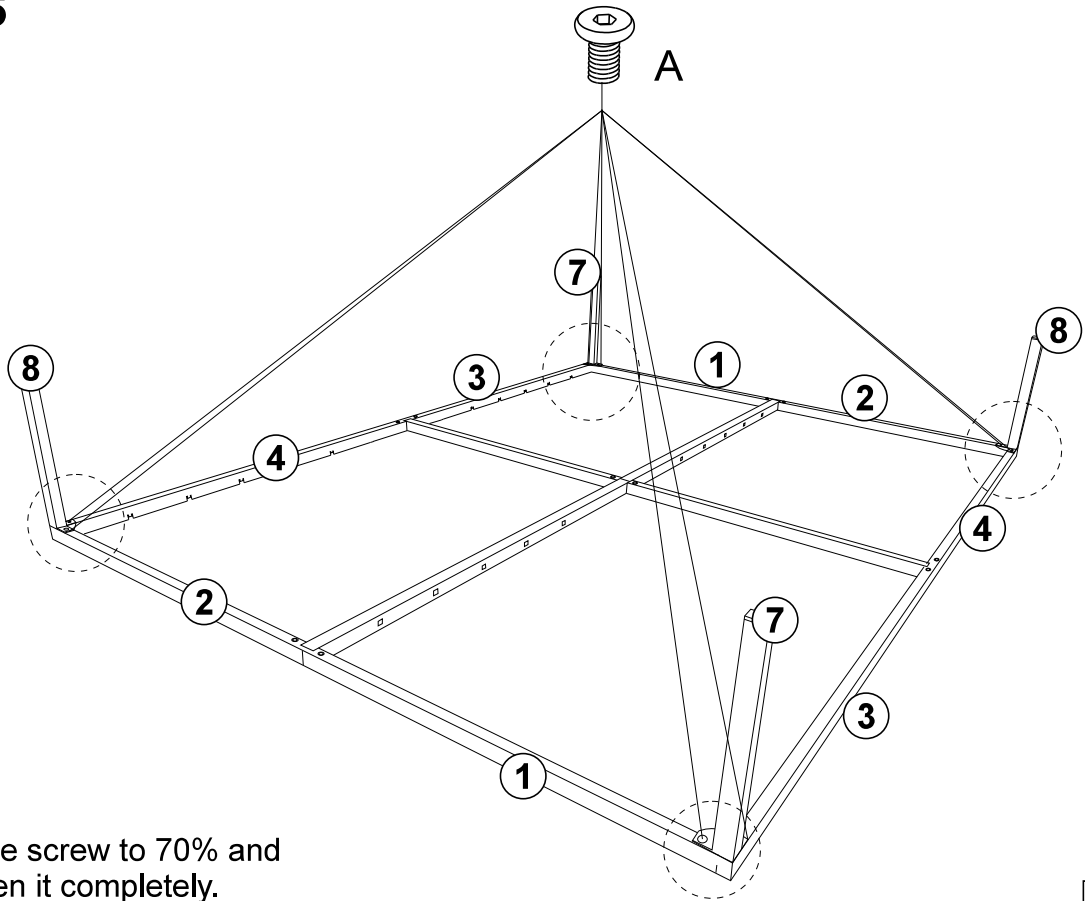

Tighten the screw to 70% and then tighten it completely.

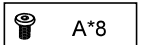

STEP 6

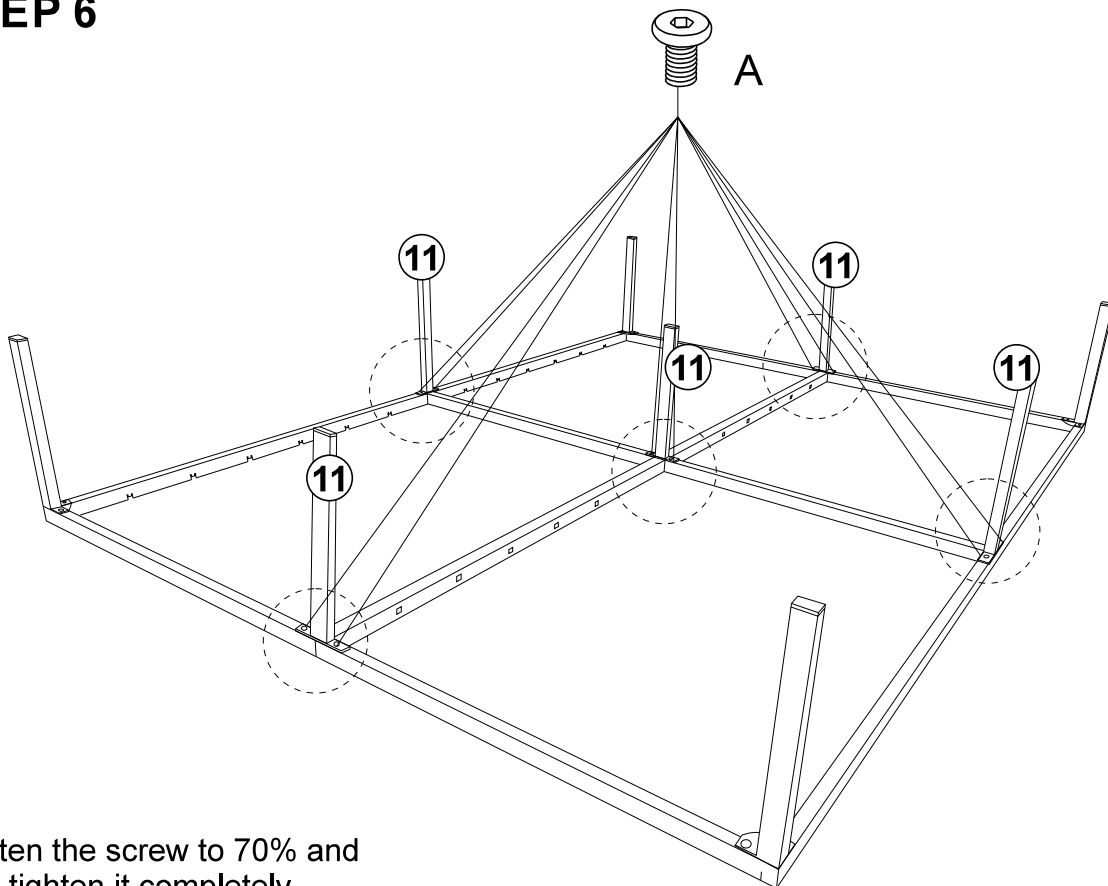

Tighten the screw to 70% and then tighten it completely.

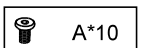

STEP 7

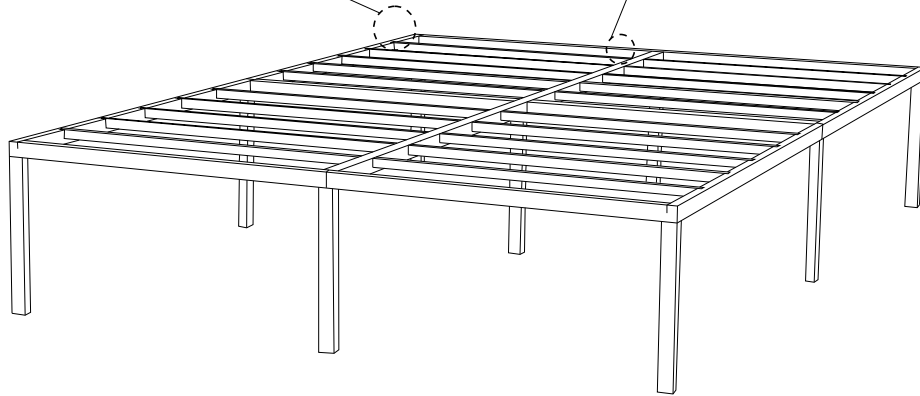
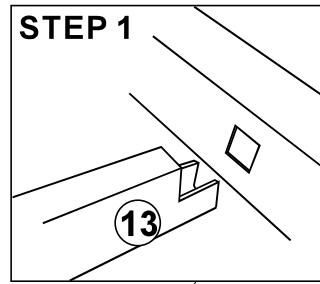
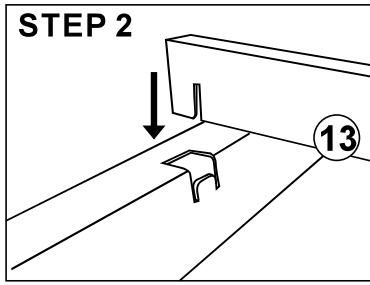

STEP 8

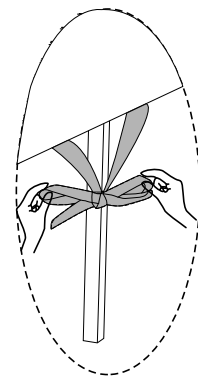
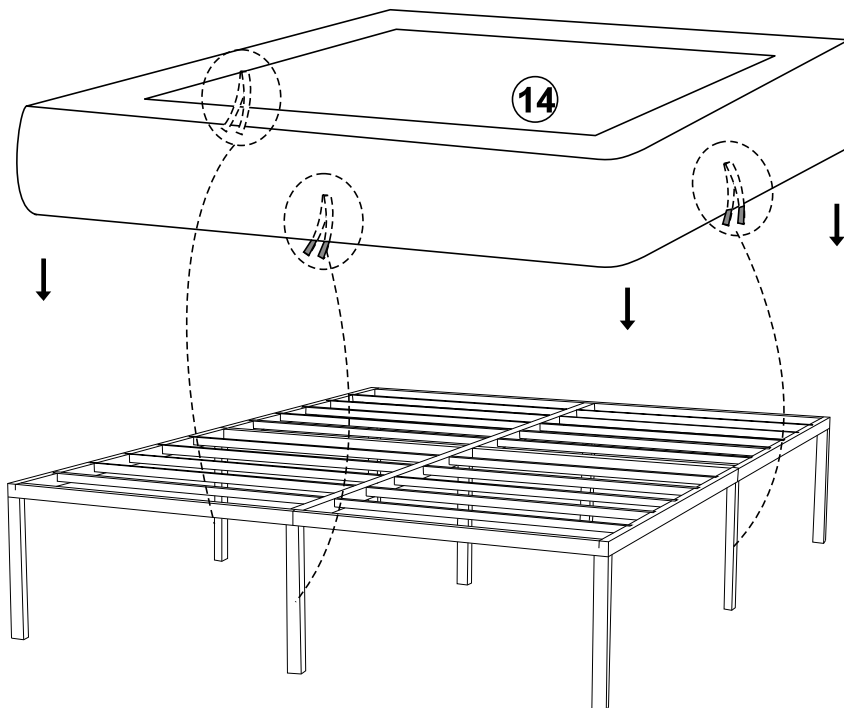

STEP 9

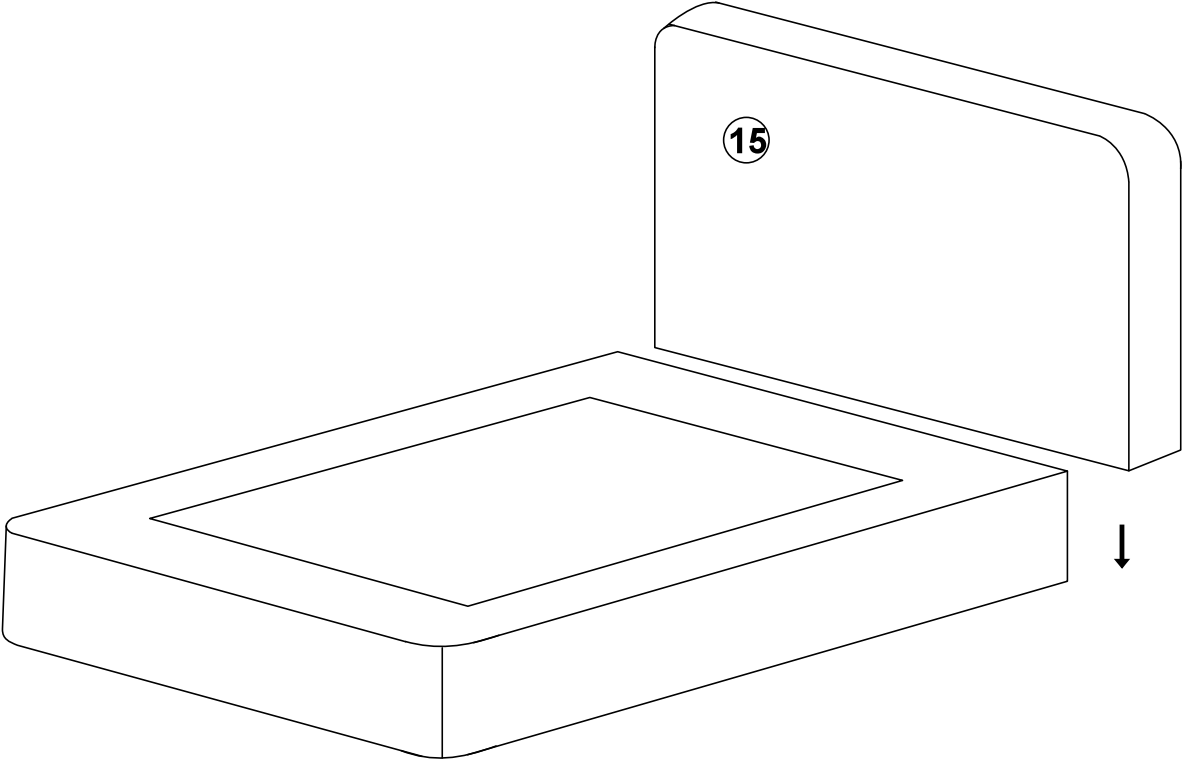

STEP 10

