

anko

**Espresso Coffee Maker
CM5428-GS
User Manual**



**PLEASE READ AND SAVE THESE
INSTRUCTIONS FOR FUTURE REFERENCE**

IMPORTANT SAFEGUARDS

Before using the electrical appliance, the following basic precautions should always be followed including the following:

1. Read all instructions.
2. Before using check that the voltage of wall outlet corresponds to rated voltage marked on the rating plate.
3. This appliance has been incorporated with a grounded plug. Please ensure the wall outlet in your house is well earthed.
4. If the supply cord is damaged, it must be replaced by qualified electrical person in order to avoid a hazard or the product must be disposed.
5. To protect against fire, electric shock and injury to persons do not immerse cord, plug, in water or other liquid.
6. Remove plug from wall outlet before cleaning and when not in use. Allow appliance cool down completely before taking off, attaching components or before cleaning.
7. Do not operate any appliance with a damaged cord or plug or after the appliance malfunctions or is dropped or damaged in any manner. Return appliance to the nearest authorized service facility for examination, repair or electrical or mechanical adjustment.
8. The use of accessory attachments not recommended by the appliance manufacturer may result in fire, electric shock or injury to persons.
9. Place appliance on flat surface or table, do not hang power cord over the edge of table or counter.
10. Ensure the power cord do not touch hot surface of appliance.
11. Do not place the coffee maker on hot surface or beside fire in order to avoid to being damaged.
12. To disconnect, remove plug from wall outlet. Always hold the plug. But never pull the cord.
13. Do not use appliance for other than intended use and place it in a dry environment.
14. Close supervision is necessary when your appliance is being used near children.
15. Be careful not to get burned by the steam.
16. Do not touch the hot surface of appliance (such as steam wand, and the steel mesh just boiling). Use handle or knobs.
17. Do not let the coffee maker operate without water.
18. Do not remove the metal funnel when appliance is brewing coffee or making steam.
19. Connect plug to wall outlet before using and turn any switch off before plug is removed from wall outlet.
20. This appliance is not intended for use by persons (including children) with reduced physical, sensory or mental capabilities, or lack of experience and knowledge, unless they have been given supervision or instruction concerning use of the appliances by a person responsible for their safety.
21. Children should be supervised to ensure that they do not play with the appliance.
22. This appliance is intended to be used in household and similar applications such as:
 - staff kitchen areas in shops, offices and other working environments;
 - farm houses;

- by clients in hotels, motels and other residential type environments;
- bed and breakfast type environments.

23. Do not use outdoors.

24. Save these instructions.

25. If you do not use the product for a long time, you need to turn on the power and then release steam for 3 minutes before leaving this product.

26. If you cut off power during steam release, residual heat will make product continue to release steam for a length of time, the product will stop releasing steam immediately once you turn off steam knob.

27. The coffee maker shall not be placed in a cabinet when in use.

28. Cleaning and user maintenance shall not be made by children without supervision.

29. The coffee maker must not be immersed.

30. For cleaning, please refer to “CLEANING AND MAINTENANCE” section.

31. Warning: Potential injury from misuse.

32. The heating element surface is subject to residual heat after use.

CAUTION: To prevent damage to the appliance do not use alkaline cleaning agents when cleaning, use soft cloth and mild detergent.

KNOW YOUR COFFEE MAKER

- | | | |
|-------------------------------|-------------------------------|--------------------|
| A. Top cover decorative sheet | B. Baffle rod | C. Steam switch |
| D. Coffee switch | E. Power switch | F. Boiler temp |
| G. Front cover | H. Steel mesh /brewing filter | I. Filter blocker |
| J. Filter holder | K. Base | L. Drip plate |
| M. Drip tray | N. Bottom cover | O. Measuring spoon |
| P. Base decorative ring | Q. Main body | R. Froth device |
| S. Steam conduit handle | T. Steam conduit | U. Water tank |
| V. Steam control knob | W. Top lid | X. Top cover |

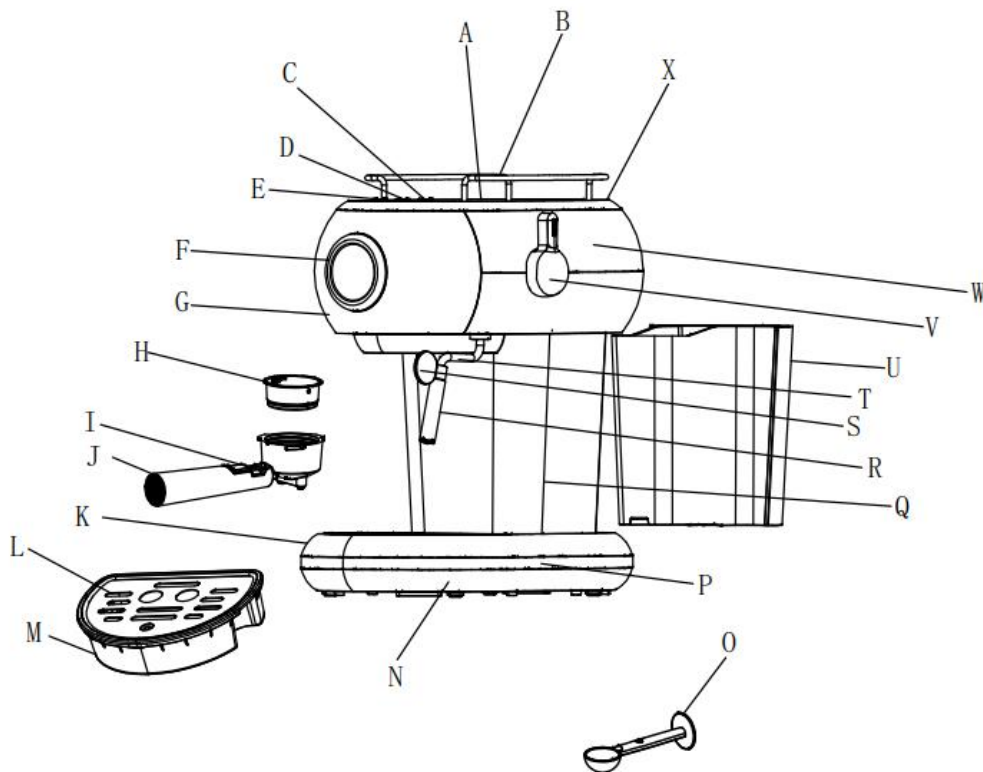

BEFORE THE FIRST USE

Remove all the plastic bags, packaging material on the Espresso Machine.

Prior to initial use and after a longer period of disuse of the Espresso Machine, allow the contents of approx. 2-3 cups of water to run through the machine without adding any coffee powder in the filter. This will clean the water circuit and all parts will be heated up for proper operation.



DANGER OF INJURY, BURNING AND SCALDING!
PLEASE READ ALL SAFETY INSTRUCTIONS AND FAMILIARISE YOURSELF WITH PARTS BEFORE USING THE MACHINE!

SETTING UP THE MACHINE

Filling the Water tank

1. Pull out the water tank.
2. Fill the tank with fresh clean water. DO NOT fill exceed MAX level.
3. Put the tank back in the espresso machine. Push lightly to ensure the water tank is properly attached to the machine.

IMPORTANT! Never operate the espresso machine without water in the tank or without fitting the water tank!

Filling the Brewing Filter

This machine includes 1 **brewing filter**: double shot filter.
Use the provided measuring spoon to add ground coffee.

1. Insert the preferred brewing filter into the filter holder.

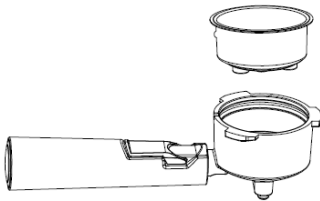

2. Add ground coffee to fill the filter. Do not fill over the MAX line marked on double shot filter.
3. Tap the filter holder several times to allow coffee evenly distributed in the filter.
4. Using the tamper press firmly on the coffee to make it flat. This is to ensure proper seal is achieved in between coffee spout and ground coffee.

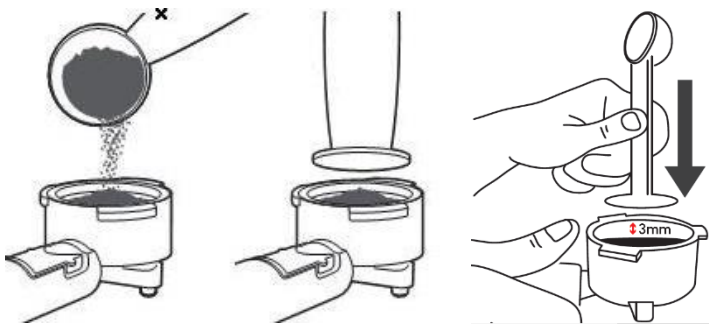



Tips

- Clean excess ground coffee from the rim to ensure proper fit under the brew head and avoid any leaks.
- The compressing of the espresso powder is an important process for preparation. If the powder is compressed tightly, the espresso will run through slowly and there will be more cream.

Pre-heat the machine and cup

To make a cup of good hot Espresso coffee, we recommend you preheating the appliance before making coffee, including the funnel, filter and cup, so that the coffee flavour cannot be influenced by the cold parts.

1. Remove the detachable tank to fill it with desired water, the water level should not exceed the "MAX" mark in the tank. Then place the tank into the appliance properly.

2. Set the steel mesh into metal funnel, make sure the tube on the funnel aligns with groove in the appliance, then insert the funnel into the appliance from the  “Unlock” mark position, and you can fix the funnel into coffee maker firmly through turn it anticlockwise until it is at the  “Lock” mark position.
3. Place the drip tray on base in position, then place drip plate on the drip tray.
4. Place an espresso cup on drip plate.
5. Then connect the appliance to power supply. Make sure the steam control knob is on the “●” position.
6. Press the power switch “” one time, the power indicator will start fading in and out. After finish preheating, the power indicator lights solidly. Press the coffee switch, when there is water flowing out from funnel, close the pump immediately by pressing the coffee switch again. The purpose of the step is to pump the water of the tank into the appliance.

It is also recommended to warm the coffee cups before making espresso, either by rinsing them with little hot water or place them on warming plate on the coffee machine.



WARNING: Do not leave the machine unattended during use!

BREWING ESPRESSO



- Insert brewing filter into the filter holder.
- Fill the brewing filter with ground coffee. (see “Filling the Brewing Filter”) Then attach the funnel onto the machine.
- Insert the funnel into the appliance at the position of  “Unlock” mark, make sure the tube on the funnel aligns with groove in the appliance. (Fig.1)



Fig.1

- Turn anti-clockwise until the handle is aligned with the  “Lock” mark. (Fig.2)

IMPORTANT! you may need to turn the handle a little harder to make the holder stop at the right locking position. This is important to prevent the holder from ejecting during use due to steam pressure.



Fig. 2

- Insert **drip tray** with drip plate. Put a coffee cup underneath the coffee spout of the filter holder.

Note: The appliance is not equipped with a cup. Please use your own coffee cup

- Insert the plug into a mains power outlet socket. Press the  button to power on the unit.

- The **Power indicator** turns on and blinks.

- After finish preheating, the power indicator lights solidly. Press the  **coffee**

button, hot espresso will flow into the cup(s)

- The appliance will stop working after 1 minute, or when you press the coffee button again during the time.

- Turn the steam control knob slowly anti-clockwise, steam will come out from the frothing device.

Note: Never turn the steam control knob rapidly, as the steam will accumulate rapidly in short time which may increase the potential of the risk of explosion.

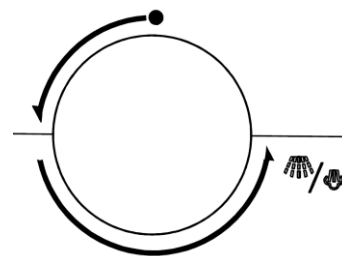



Fig. 3



Risk of burning! Parts of the espresso machine become very hot during and immediately after operation. Do not touch hot surfaces, especially the metal parts. Always touch handles or wait until parts have cooled down.



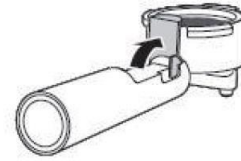

Risk of scalding! Rising steam can cause burns. Be aware hot water/hot steam that may escape from the espresso machine during use.

Emptying the brewing filter

1. Remove the filter holder from the machine.
2. Turn the filter holder to  “Unlock” mark position, then pull it down gently.
3. Fold the filter blocker up and over the edge to hold the brewing filter. Refer to figure shown.
4. Hold the handle placing your thumb/finger on the filter blocker, this will prevent the filter from falling out, turn it upside down to knock out and remove the espresso powder.



MAKE ESPRESSO

1. Remove the funnel by turning it in clockwise. Add ground coffee to steel mesh with measuring spoon, a spoon ground coffee power can make about a cup of top-grade coffee, then press the ground coffee powder tightly with the tamper.
2. Set steel mesh into metal funnel, make sure the tube on the funnel aligns with groove in the appliance, then insert the funnel into the appliance from the  “Unlock” mark position, and you can fix them into coffee maker firmly through turn it anticlockwise until it is at the  “Lock” mark position.
3. Pour the hot water in the cup, after the cup is warmed up, empty the water in the cup and dry the cup, and then place the hot cup on drip plate.
4. At the time, the lamp in  power button shall be illuminated solidly, if it is fading in and out, wait for a moment, once the lamp in it is illuminated solidly, press the  coffee button then wait for a moment, there will be coffee flowing out. Press the  coffee button again when the required amount is reached, and then the water pump stops working.

WARNING:

1. Do not leave the coffee maker unattended during making the coffee, as you need operate manually sometimes!
2. After finishing making the coffee, you can take the metal funnel out by turning the funnel handle clockwise.
3. Then pour the coffee residue out with the steel mesh with filter holder.
4. Let them cool down completely, then rinse under running water.
5. Recommended single coffee cup approximately 30ml, double coffee cup approximately 60ml.the working time for brewing single-cup of coffee is 60 seconds at most, and the water pump will stop working if the working time exceeds 60 seconds.

MAKE HOT WATER

When the preheating is finished, the power indicator lights up solidly. Then press the steam switch twice in a row for 2 seconds, and the water pump starts to pump water. Turn the steam knob anticlockwise and then hot water will flow out of the steam pipe. To stop making hot water,

press the steam switch again, then turn the steam knob clockwise to close the steam pipe. Hot water is used for warming cup, making tea or cooling down the appliance.

MAKE CAPPUCCINO/FROTHED MILK

You get a cup of cappuccino when you top up a cup of espresso with frothed milk.

Method:

1. Prepare espresso first with container big enough according to the part “MAKE ESPRESSO COFFEE”, make sure that the steam control knob is at the “●” position.
2. Press the steam switch selector, wait for until the indicator in the steam switch selector is illuminated solidly.

Note: During operation, the indicator in the steam switch selector will cycle on and off to maintain to desired temperature.

3. Fill a jug with about 100 mL of milk for each cappuccino to be prepared, you are recommended to use whole milk at refrigerator temperature (not hot!).

Note: In choosing the size of jug, it is recommended the diameter is not less than 70 ± 5 mm, and bear in mind that the milk increases in volume by 2 times, make sure the height of jug is enough.

4. Turn the steam control knob slowly anti-clockwise, steam will come out from the frothing device.

Note: Never turn the steam control knob rapidly, as the steam will accumulate rapidly in short time which may increase the potential of the risk of explosion.

5. Insert the frothing device into the milk about two centimetre, froth milk in the way moving vessel round from up to down.
6. When the required purpose is reached, you can turn the steam control knob to “●” position.

Note: Clean steam outlet with wet sponge immediately after steam stops generating, but care not to hurt!

7. Pour the frothed milk into the espresso prepared, now the cappuccino is ready. Sweeten to taste and if desired, sprinkle the froth with a little cocoa powder.

Note: If the amount of steam is found to be relatively small during use, the coffee machine may be because there is no water in the heating pot. It is necessary to press the steam button twice continuously to fill the heating pot with water and then repeat the steam.

8. Press the Power switch to cut the power source off. All indicators will be extinguished.

WARNING: After finish the “Steam” function, press the coffee switch, if the coffee indicator and steam indicator blink fast, it means that the temperature of the appliance is too high and the appliance needs to be turned off and have a rest for more than 5minutes, or you can activate the “Hot water” function to cool down the appliance. And the water pump will stop pumping water automatically if the temperature is normal. And the coffee will be burnt and there will be overflow at the funnel if the appliance brew coffee directly without being cooled down.

Cleaning milk frother

After milk frothing, the steam nozzle must be cleaned. Not doing so may result in steam blockage.

1. Place an empty large cup underneath the milk frother nozzle.
2. Turn on the **steam controller** and wait for approx. 15 seconds, then close the steam controller.
3. Wipe the nozzle with a clean damp cloth.
4. Detach the nozzle and wipe the milk frother with a clean damp cloth.

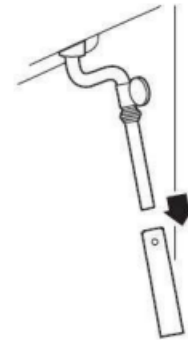

IMPORTANT! Ensure the detachable nozzle is fitted firmly back in place after cleaning. If not fitted firmly back in position, the nozzle may detach during frothing due to steam pressure.



Tips

- Any milk can be frothed (also soya and rice milk). However, some varieties of milk, e.g. whole dairy milk, will give better results than others. Skimmed milk does not froth as easily as whole milk due to low fat content. Therefore, we recommend using milk with a fat content 1.5% to 3.5% for finer froth.
- Well-chilled milk foams better than less-chilled milk. Recommended temperature: approx. 7°C.
- Do not froth milk a second time (due to risk of scalding).
- Allow the frothed milk to stand for approx. 30 seconds before putting the froth on the espresso. During this time, larger bubbles will burst and milk, which is still liquid, sinks to the bottom. The froth becomes even finer this way.

AFTER USE

- Press the  button to turn off the machine.
- Pull the power plug off from the mains power outlet socket.
- Allow the machine cool down for a few minutes.

Quick clean

Wipe all parts with a damp soft cloth, such that coffee grounds and milk residues do not dry on the machine.

Empty the drip tray

The drip tray needs emptying as soon as the drip tray is full when seen from the hole.

Carefully lift the drip tray off the espresso machine, remove the draining rack and pour the water into the sink.

AUTOMATIC POWER OFF FUNCTION

If there is no any operation within 25 minutes, the unit will power off automatically.

CLEANING AND MAINTENANCE



DANGER OF BURNING!

The espresso machine becomes hot during operation. Metal parts particularly remain hot for longer time.

Prior to cleaning, wait until the espresso machine has cooled down completely.



SHORT-CIRCUIT HAZARD!

Water, which has penetrated the housing, may cause a short-circuit. Never immerse the espresso machine in water or other liquids. Ensure that no water or other liquids enter into the housing.

Always switch off the machine and pull off the plug mains power before cleaning!



RISK OF DAMAGE!

Improper handling of the espresso machine may result in damage. Do not use any aggressive detergents, sharp or metallic cleaning implements, such as knives, hard spatulas and similar. These may damage the surfaces.

1. Clean the filter holder, brewing filter and the drip tray with a little detergent under warm running water and rinse through with clear water.
2. Pull the metal nozzle off the milk frother and clean it with a little detergent under warm running water. Rinse it thoroughly with clear water.
3. Wipe the handle and the milk frother with a slightly damp cloth.
4. Let all parts dry before reassembling.
5. Regularly wipe down the housing of the machine with a slightly damp cloth.

Descaling

Descale the coffee maker regularly. To do this, use a commercially available descaling product (kettle descaling solution) and follow instructions provided with product.

Storage

1. Prior to longer storage, clean the espresso machine thoroughly.
2. Empty the water tank and the drip tray.
3. Allow all parts to dry completely.
4. Store the espresso machine in a dry, frost and dust free location.

TROUBLESHOOTING

Symptom	Cause	Corrections
Water leaks from the bottom of coffee maker.	There is much water in the drip tray.	Please clean the drip tray.
	The coffee maker is malfunction.	Please contact with the authorized service facility for repairing.
Water leaks out of outer side of filter.	There is some coffee powder on filter edge.	Get rid of them.
Acid (vinegar) taste exists in Espresso coffee.	No clean correctly after cleaning mineral deposits.	Clean coffee maker per the content in “before the first use” for several times.
	The coffee powder is stored in a hot, wet place for a long time. The coffee powder turns bad.	Please use fresh coffee powder, or store unused coffee powder in a cool, dry place. After opening a package of coffee powder, reseal it tightly and store it in a refrigerator to maintain its freshness.
The coffee maker cannot work anymore.	The power outlet is not plugged well.	Plug the power cord into a wall outlet correctly, if the appliance still does not work, please contact with the authorized service facility for repairing.
The steam cannot froth.	The steam ready indicator is not illuminated.	Only after the steam ready indicator is illuminated, the steam can be used to froth.
	The container is too big or the shape is not fit.	Use high and narrow cup.
	You have used skimmed milk	Use whole milk or half-skimmed milk

TECHNICAL SPECIFICATION

Voltage: 220-240V~ 50-60Hz

Power: 1100W

12 Month Warranty

Thank you for your purchase.

Your new product is warranted to be free from defects in materials and workmanship for the period stated above, from the date of purchase, provided that the product is used in accordance with accompanying recommendations or instructions where provided. This warranty is in addition to your rights under the Australian Consumer Law.

For New Zealand customers, this warranty is in addition to statutory rights observed under New Zealand legislation.

We will provide you with your choice of a refund, repair (where possible) or exchange (availability dependent) for this product if it becomes defective within the warranty period. The business will bear the reasonable expense of claiming the warranty.

This warranty will no longer apply where the defect is a result of alteration, accident, misuse, abuse or neglect.

Please retain your receipt as proof of purchase and contact our Customer Service Centre as listed below, for the entity you purchased this product from, for any difficulties with your product. Warranty claims and claims for expense incurred in returning this product can be addressed to the respective Customer Service Centre.

Our goods come with guarantees that cannot be excluded under the Australian Consumer Law. You are entitled to a replacement or refund for a major failure and compensation for any other reasonably foreseeable loss or damage. You are also entitled to have the goods repaired or replaced if the goods fail to be of acceptable quality and the failure does not amount to a major failure.

Contact for Kmart purchases	Contact for Target purchases
Kmart Australia Ltd. C/- Customer Service Centre L2/ 1 Middle Road, Chadstone Vic 3148 Australia Customer Service: 1800 124 125 (Australia) or 0800 945 995 (New Zealand) or via Customer Help at kmart.com.au	Target Australia Pty Ltd C/- Customer Service Centre L2/ 1 Middle Road, Chadstone Vic 3148 Australia Customer Service: 1300 753 567 or via Customer Help at target.com.au/help/contact-us

ESPRESSO COFFEE MAKER QUICK INSTALLATION GUIDE

CM5428-GS

1. Align the handle (lever) on the filter holder to the left of **UnLock** symbol.



2. Insert the filter holder slightly into the Espresso Coffee Maker.



3. Turn handle towards the **Lock** symbol until it is tight and secured.



4. To remove filter - Align the gap in the filter and holder and then take the filter out.

