

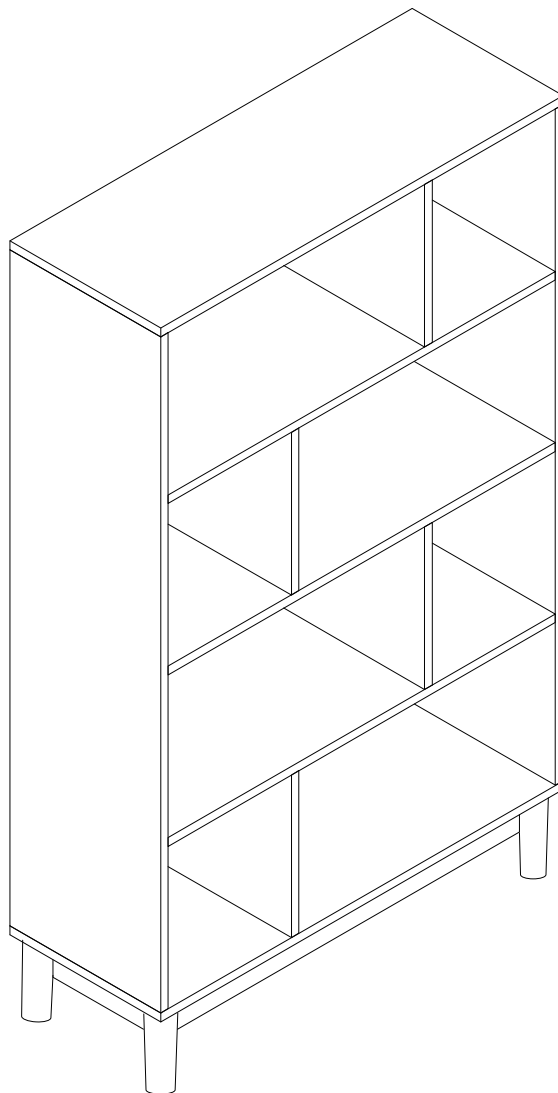

THORNE BOOKSHELF

Instruction Manual



The photos and illustrations shown in this instruction manual are generic.
The manufacturer reserves the right to change any specification or feature without prior notice.

IMPORTANT: KEEP FOR FUTURE REFERENCE. READ CAREFULLY.

Assembly Instruction

43683390 THORNE BOOKSHELF

CARE INSTRUCTIONS:











WIPE CLEAN WITH A DRY CLOTH. NOT USE ABRASIVE MATERIALS AND SOLVENTS. CHECK AND TIGHTEN ALL PARTS REGULARLY. KEEP AWAY FROM WATER AND DIRECT SUNLIGHT. STORE IN A DRY PLACE. FOR DOMESTIC USE ONLY. FOR INDOOR USE ONLY. A MILD ODOUR MAY BE PRESENT WHEN FIRST OPENING THIS CARTON. SIMPLY ALLOW TO AIR OUTSIDE AND THIS WILL FADE.

WARNING:



DO NOT STAND OR SIT ON THIS UNIT. DO NOT USE THIS UNIT UNLESS ALL BOLTS AND SCREWS ARE FIRMLY SECURED. DO NOT KNOCK OR DRAG THIS UNIT. USE ONLY ON A FLAT SURFACE. ADULT ASSEMBLY REQUIRED. FAILURE TO FOLLOW THESE WARNING COULD RESULT IN SERIOUS INJURY. LOAD DRAWER EVENLY TO PREVENT FROM TIPPING OVER. THIS PACKAGE CONTAINS SMALL PARTS AND SHARP POINTS. KEEP AWAY FROM CHILDREN AND BABIES.

MAXIMUM SAFE LOAD: 5KGS FOR SHORT SHELF, 10KGS FOR LONG SHELF.

1 Hardware List

a		6x35mm	16pcs	b		15x9.5mm	16pcs	c		6x30mm	44pcs	d		4x35mm	4pcs
m			16pcs	f		4x55mm	8pcs	g		4x25mm	16pcs	h		6x55mm	8pcs
i		4x12mm	2pcs	j		4x35mm	2pcs								

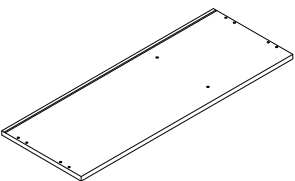
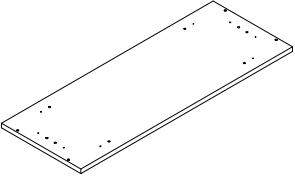
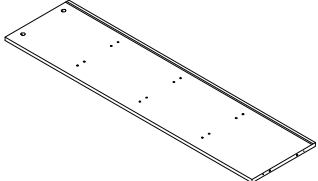
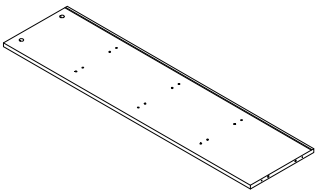
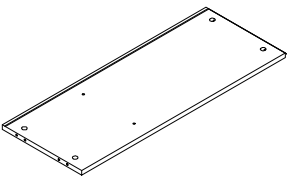
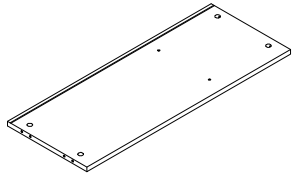
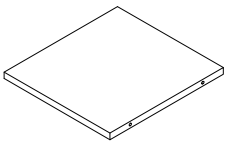
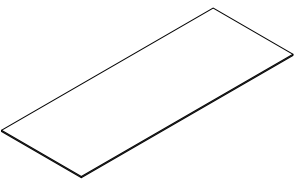
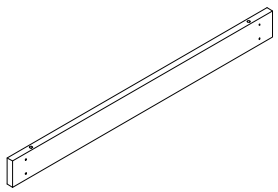
2 Parts List

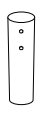
					
①	1PC	②	1PC	③	1PC
					
④	1PC	⑤	2PCS	⑥	1PC
					
⑦	4PCS	⑧	4PCS	⑨	2PCS
					
⑩	2PCS	⑪	4PCS	⑫	4PCS

PANEL LAYOUT

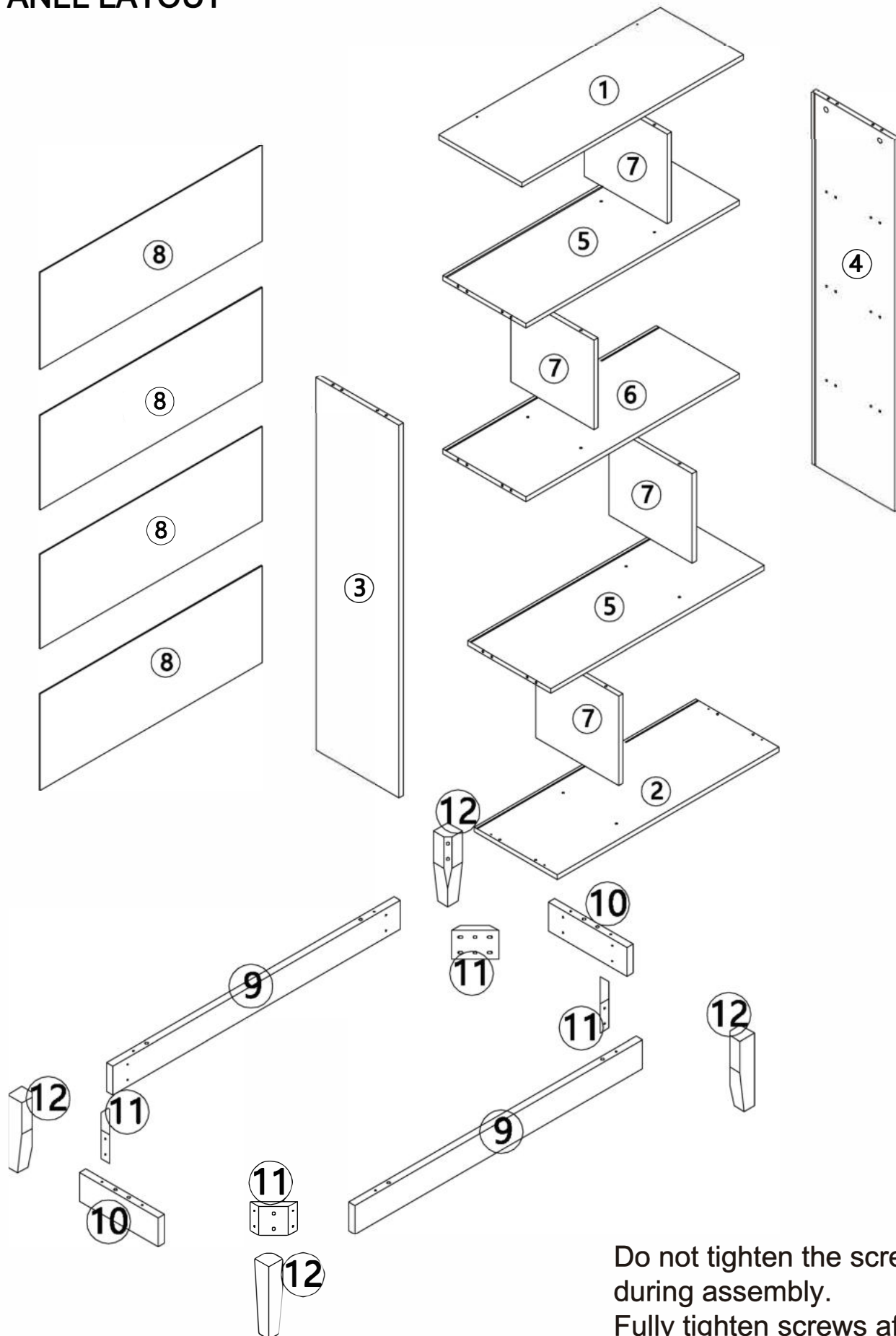

Do not tighten the screws fully during assembly.
Fully tighten screws after the final assembly steps.

STEP 1

 x 8

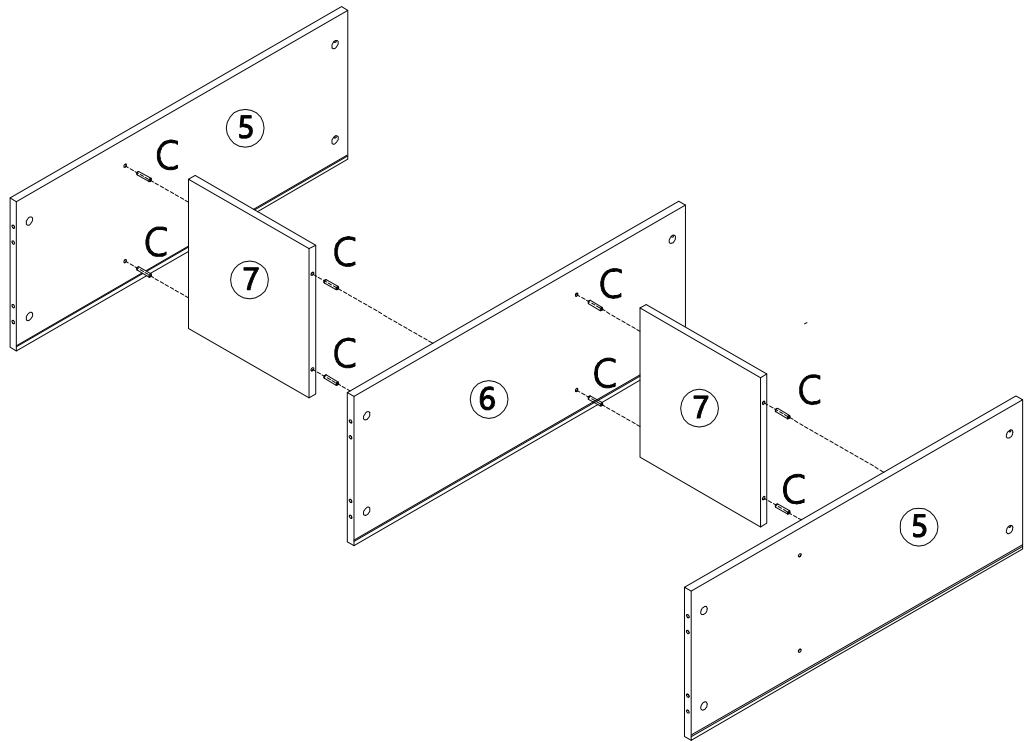

STEP 2

 x 6  x 6  x 6

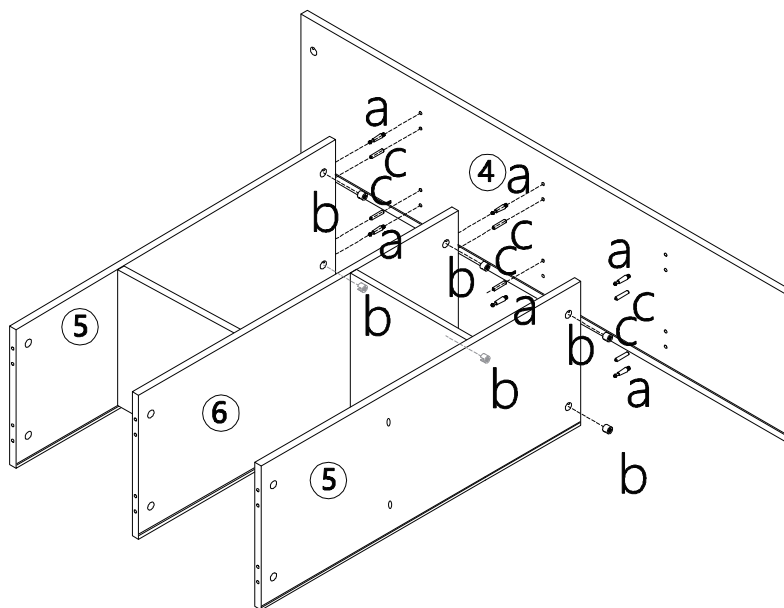

STEP 3

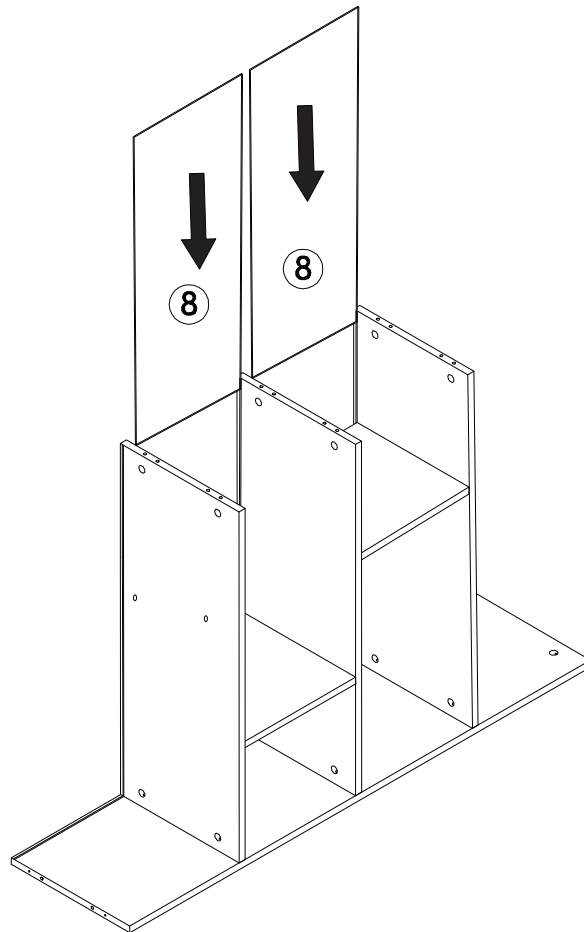

STEP 4

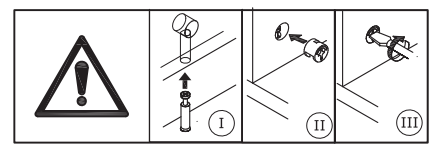
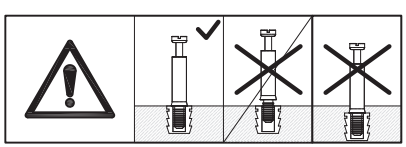
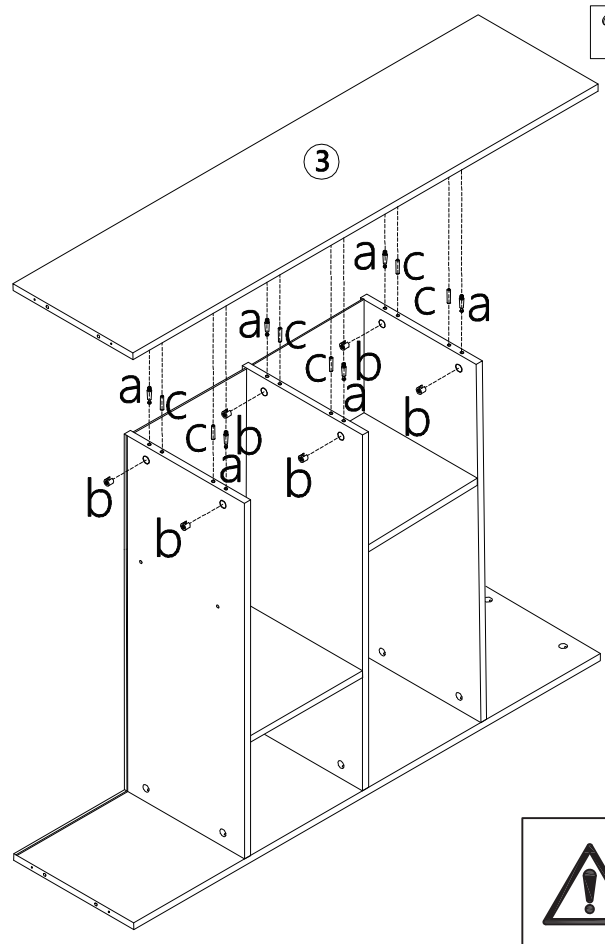

STEP 5

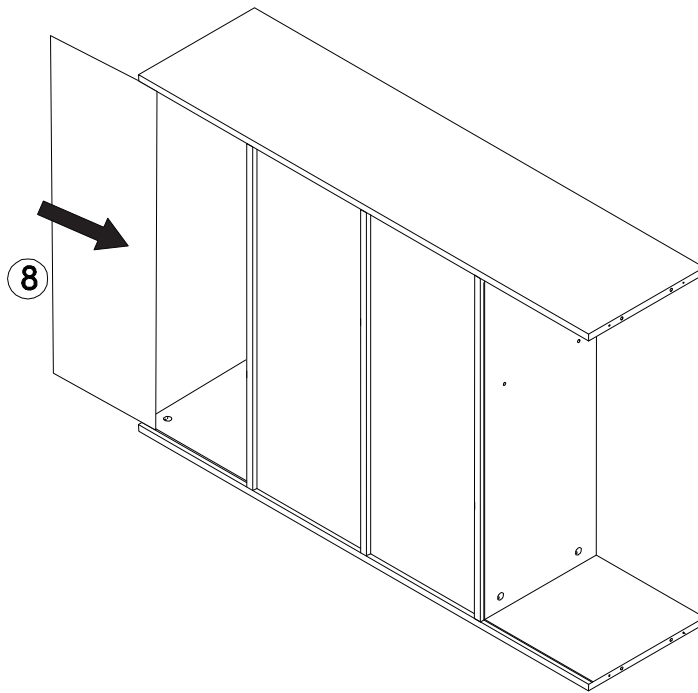

STEP 6

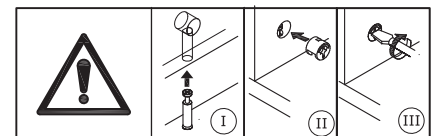
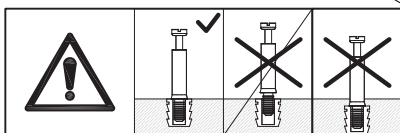
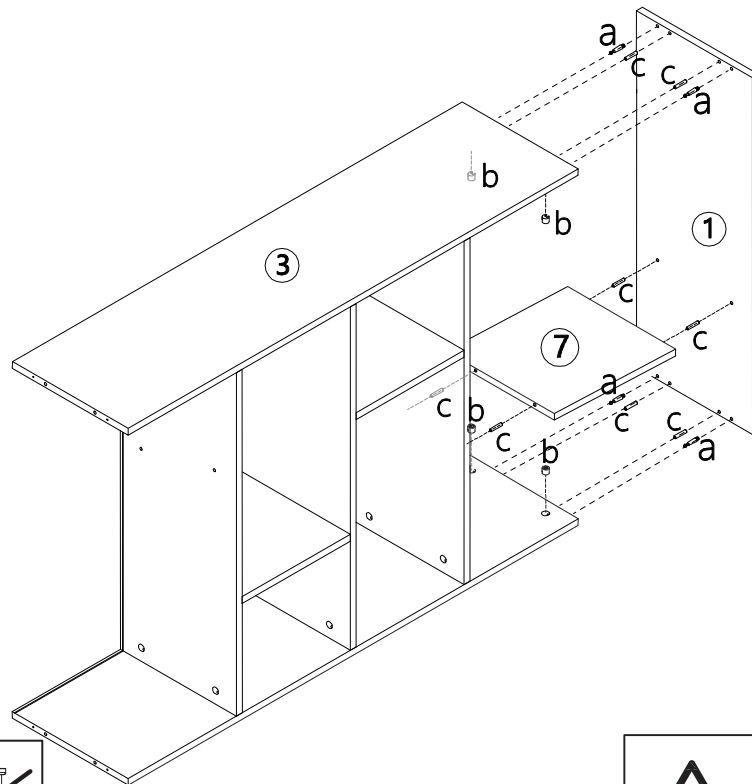

STEP 7

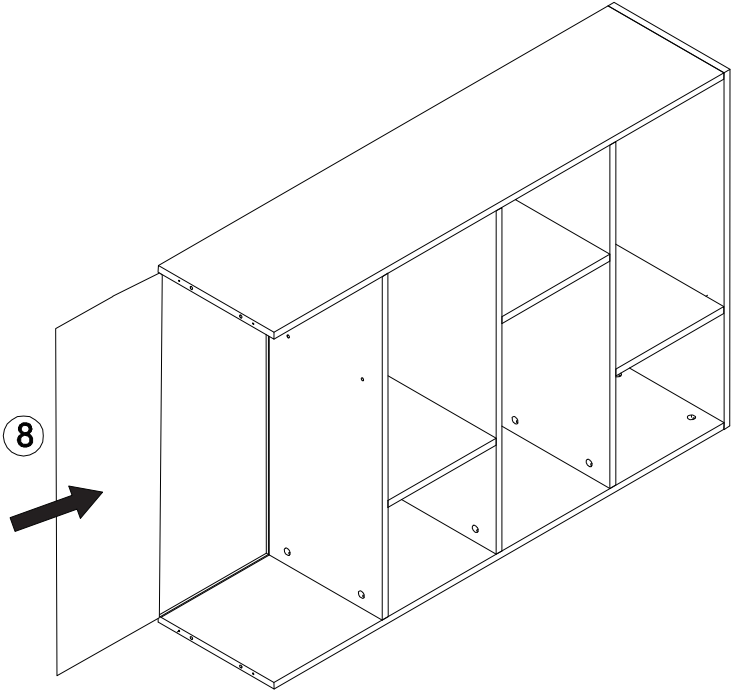

STEP 8

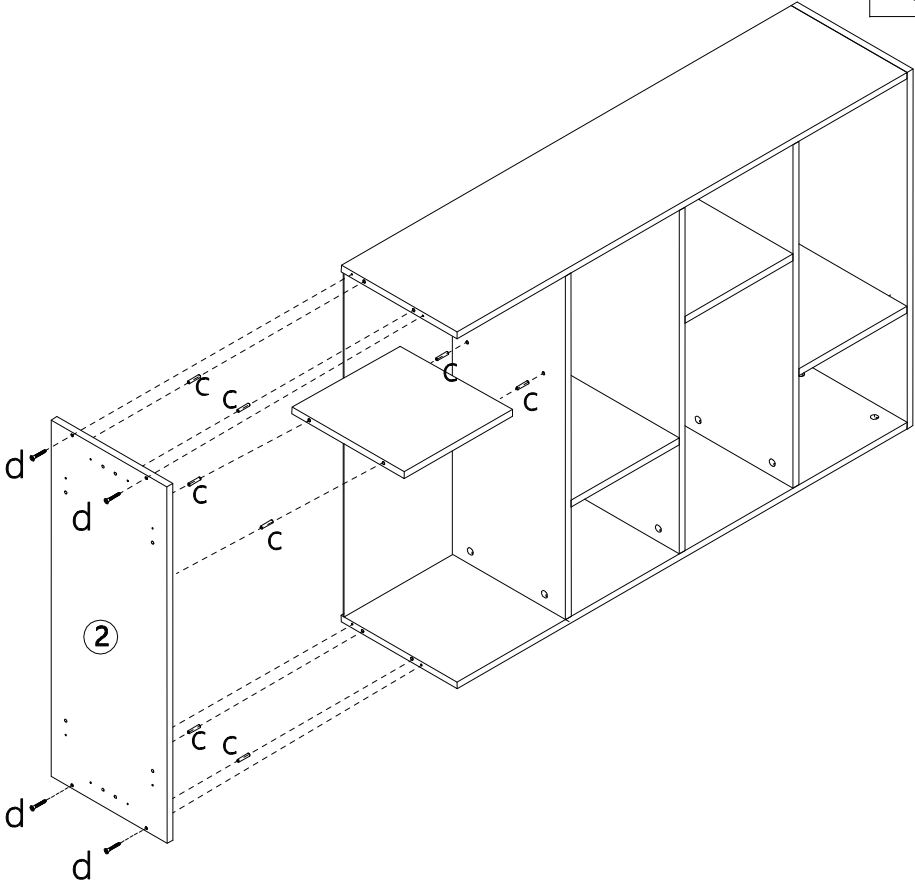

STEP 9

 x8  x8

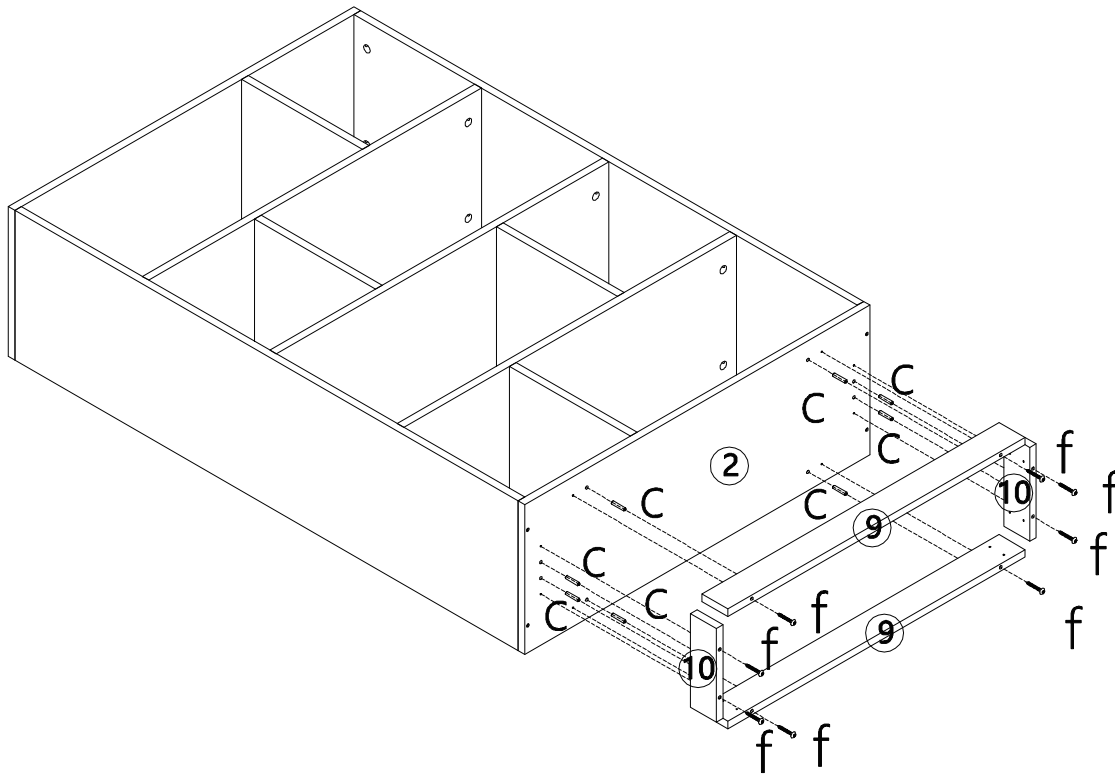

STEP 10

 x16

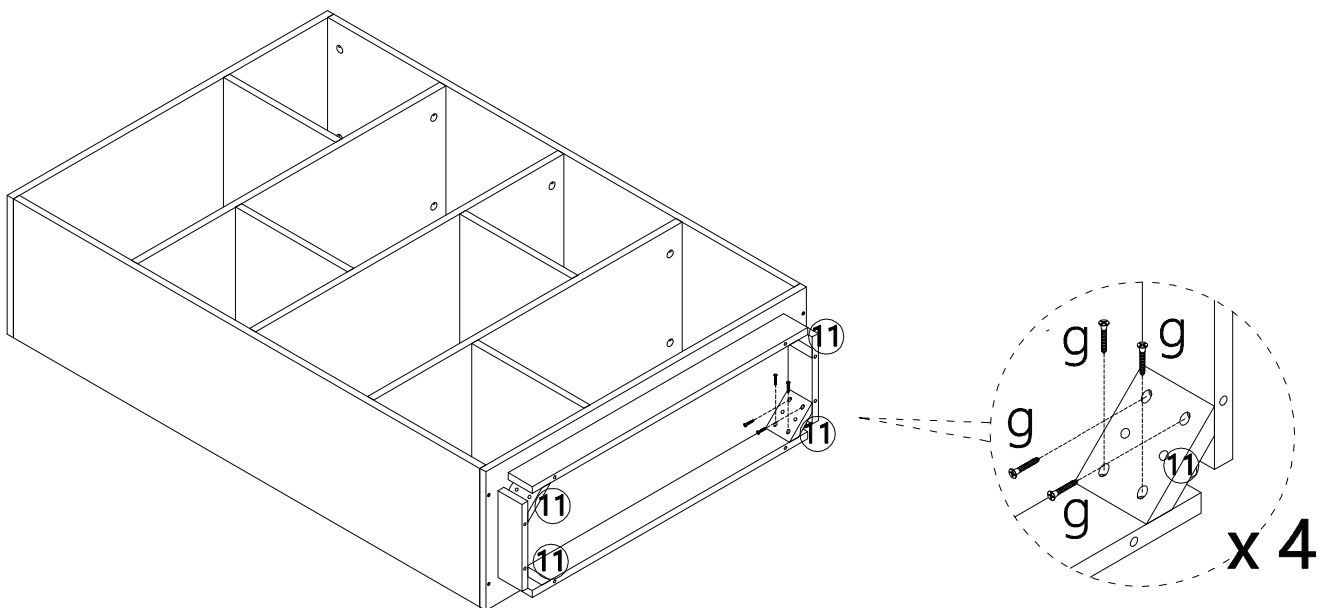

STEP 11

 x 16

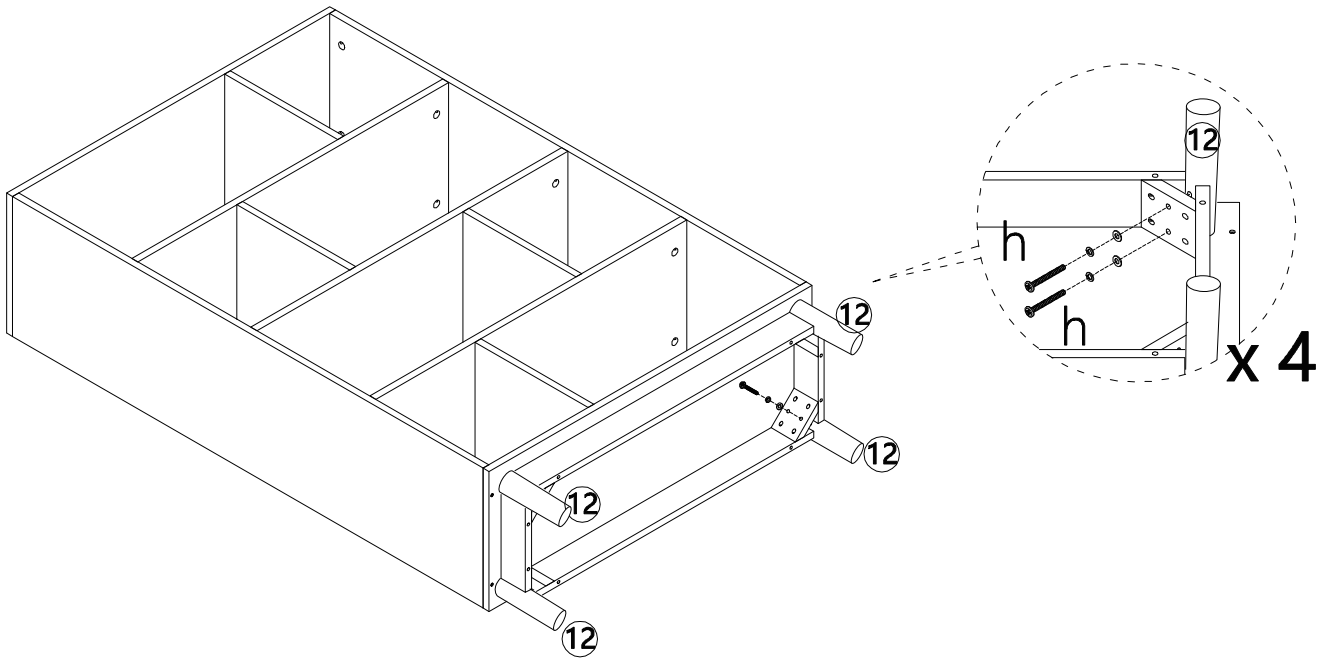

STEP 12

 x 16

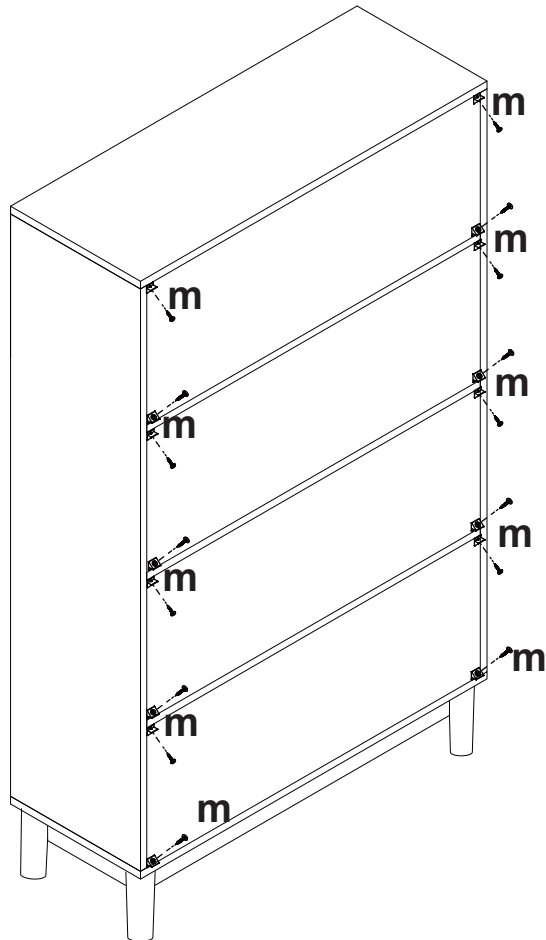

STEP 13

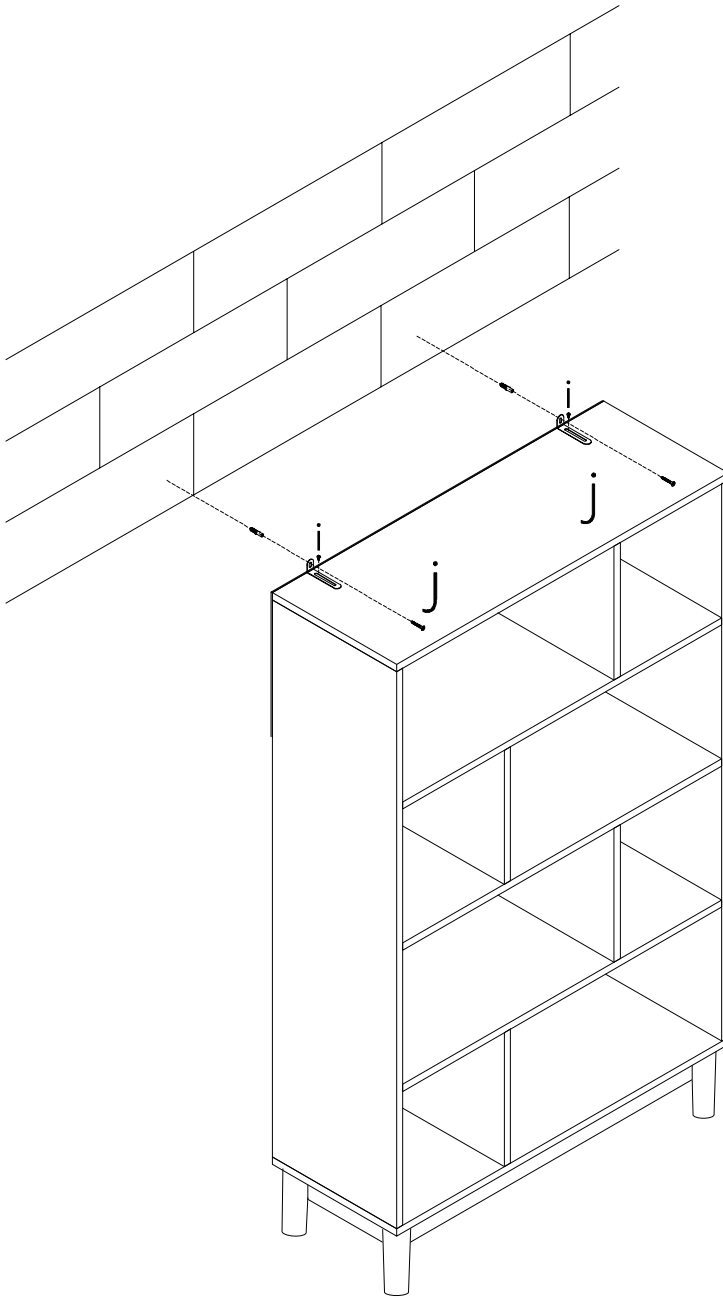

⚠ WARNING	
	
<p>Children have died from furniture tipover.</p> <ul style="list-style-type: none">• ALWAYS secure it with an anchor device.• NEVER allow children to stand, climb or hang on drawers, doors, or shelves.• NEVER open more than one drawer at a time.• Place heavy items down low.	
<p>NEVER put a TV on this furniture </p>	
<p>This is a permanent label. Do not remove!</p>	

TOPPLING FURNITURE WARNING:

- **ALWAYS secure it with an anchor device**
- **Please seek professional advice if you are in doubt of what fixing device to use.**
- **Regularly check that anchors are securely maintained.**
- **Use safety drawer locks to prevent children climbing.**
- **Stability of tall items may be affected by thick pile carpet or uneven floors .**
- **Do not place unanchored televisions on furniture .**

CAUTION: for your safety when attaching the anchor fixings, please note the following:

- **Check any electrical wires or plumbing inside the wall before drilling any holes (if you are unsure please seek professional advice from a qualified tradesperson).**



TOPPLING HAZARD

WARNING: PLEASE SECURE YOUR FURNITURE WITH THE SUPPLIED WALL FIXING. SCAN THE CODE FOR MORE INFORMATION.

