

miniblocks

# Jacaranda Tree In Dome

## Instructions

10+  
years

Flower  
Series

1372  
PIECES

Difficulty Level



K: 43-626-670 | T: 71-969-961

1

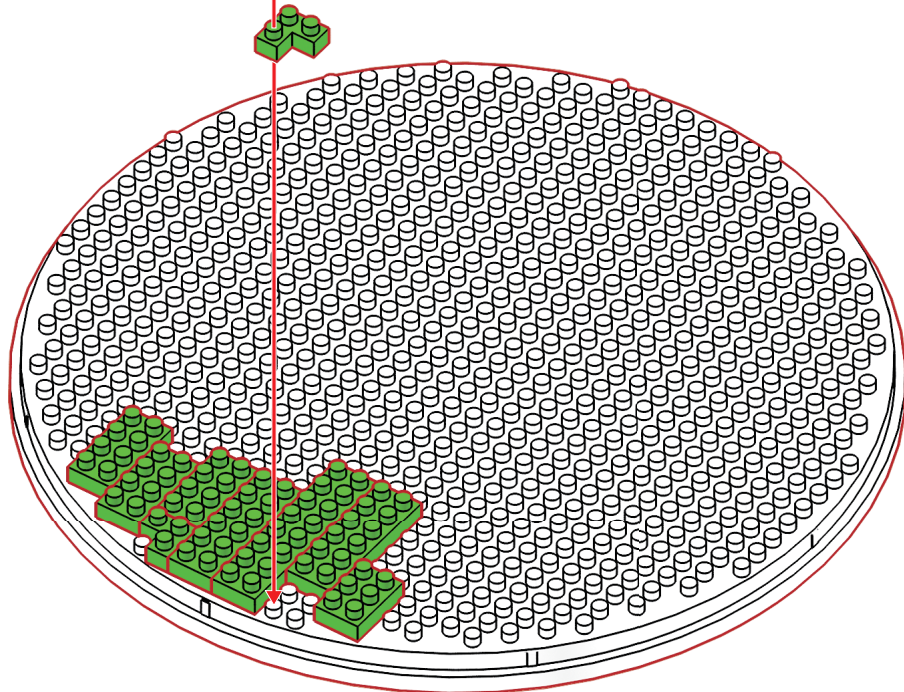
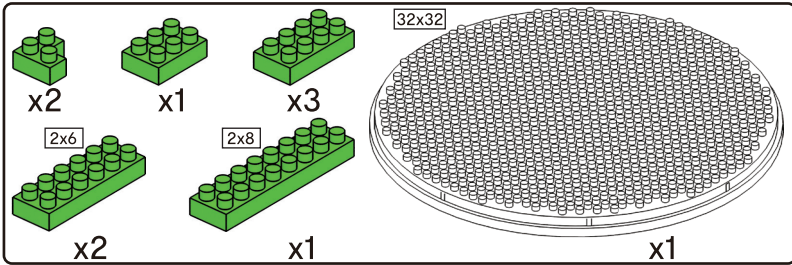

2

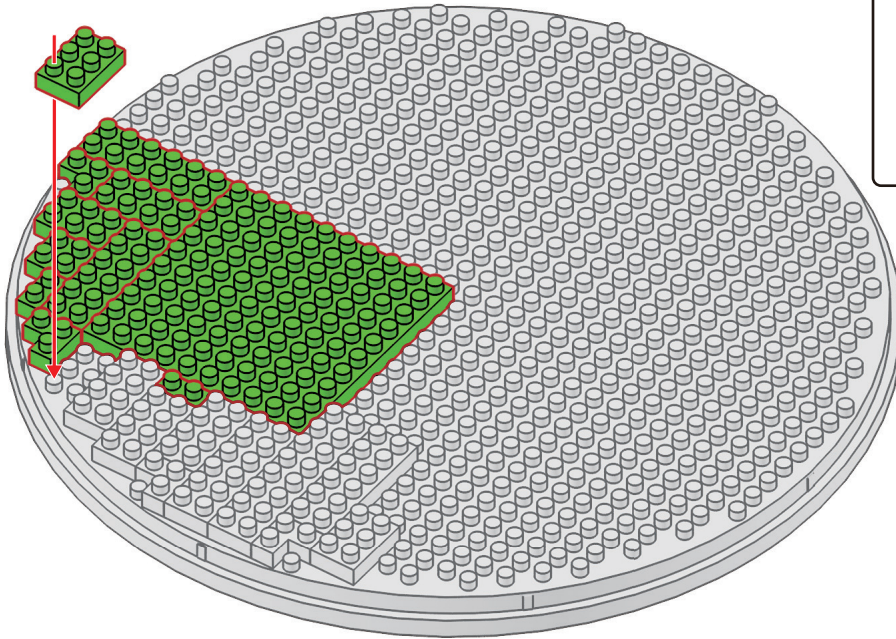
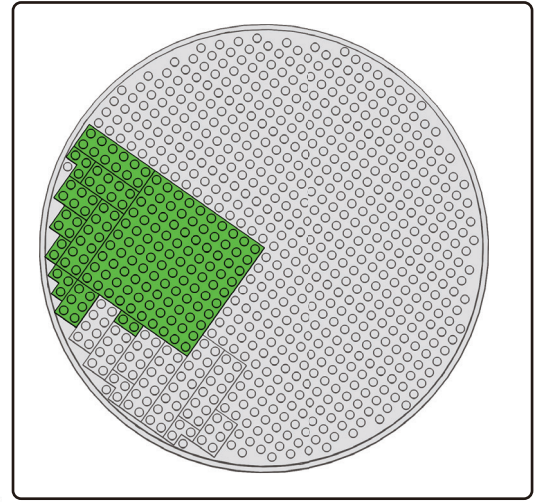
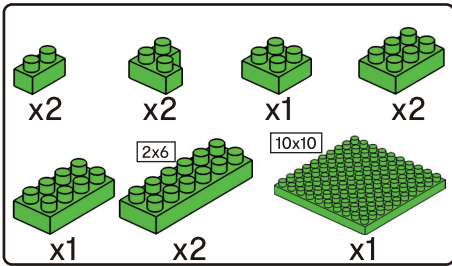

3

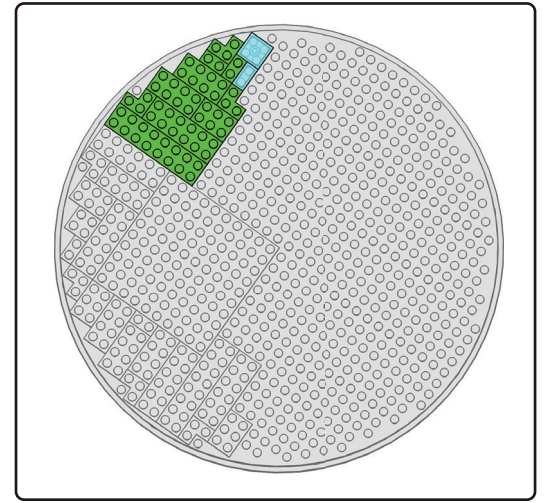
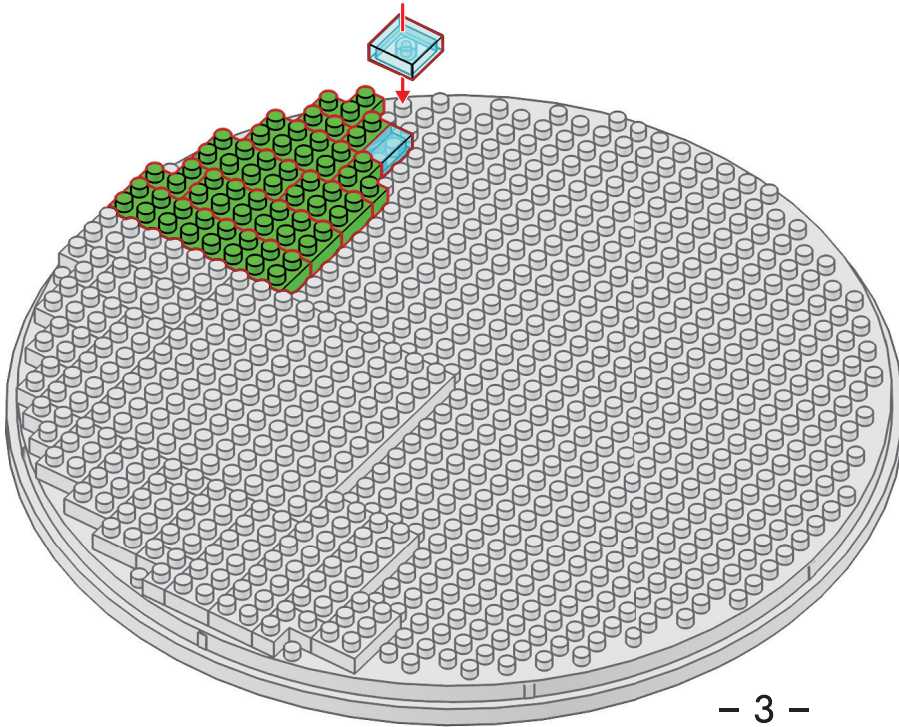
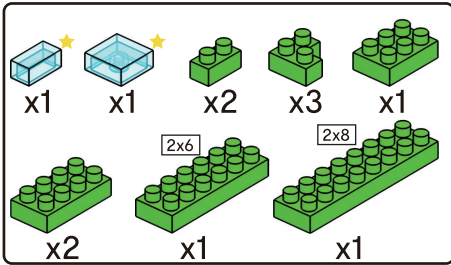

4

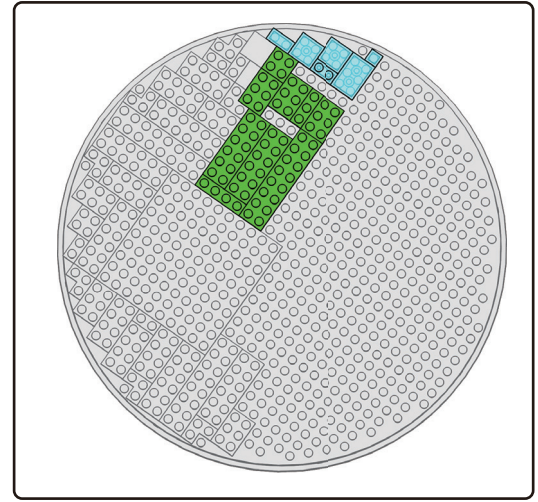
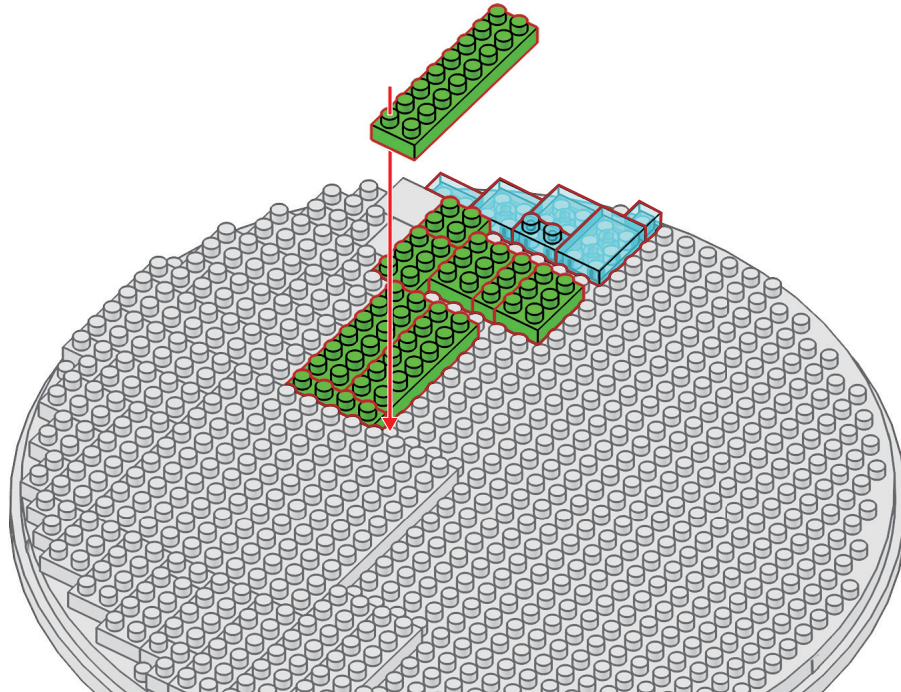
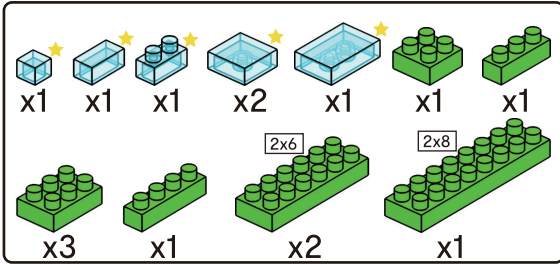

5

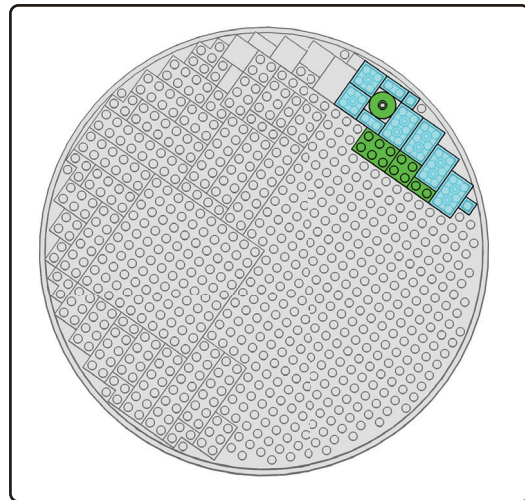
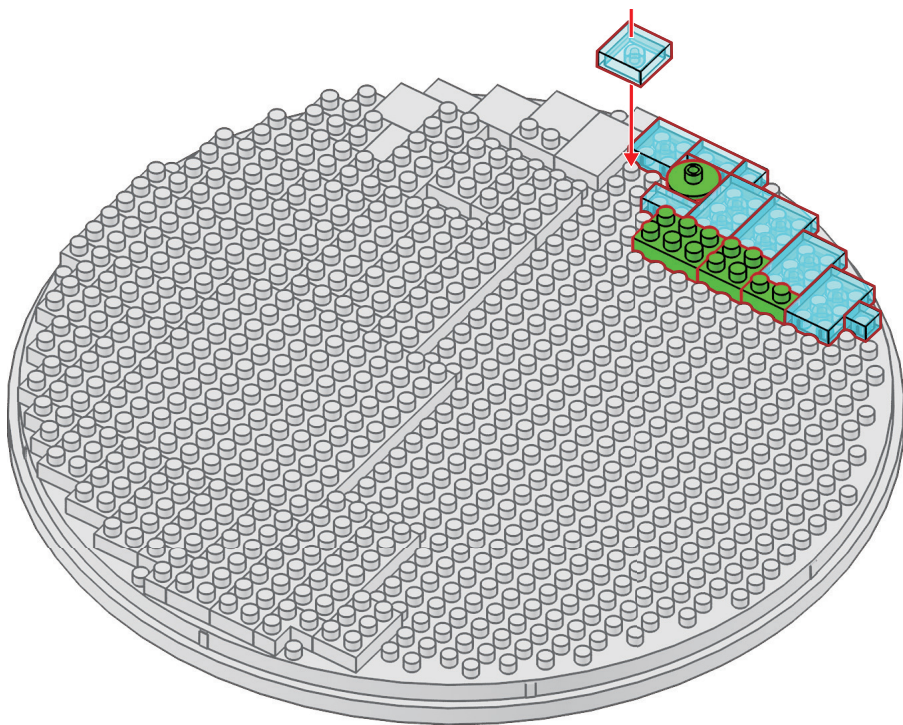
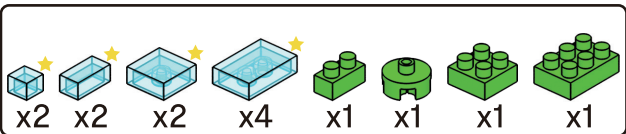

6

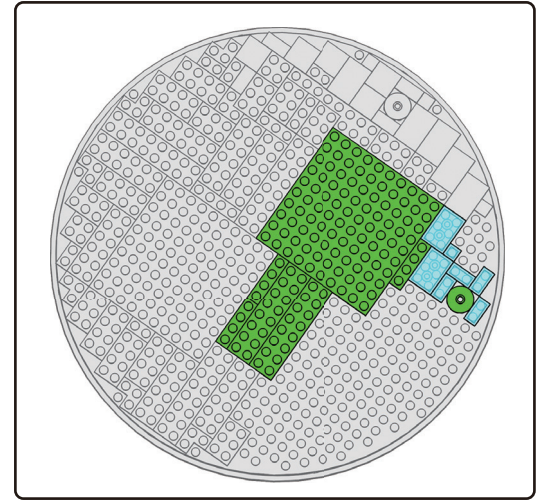
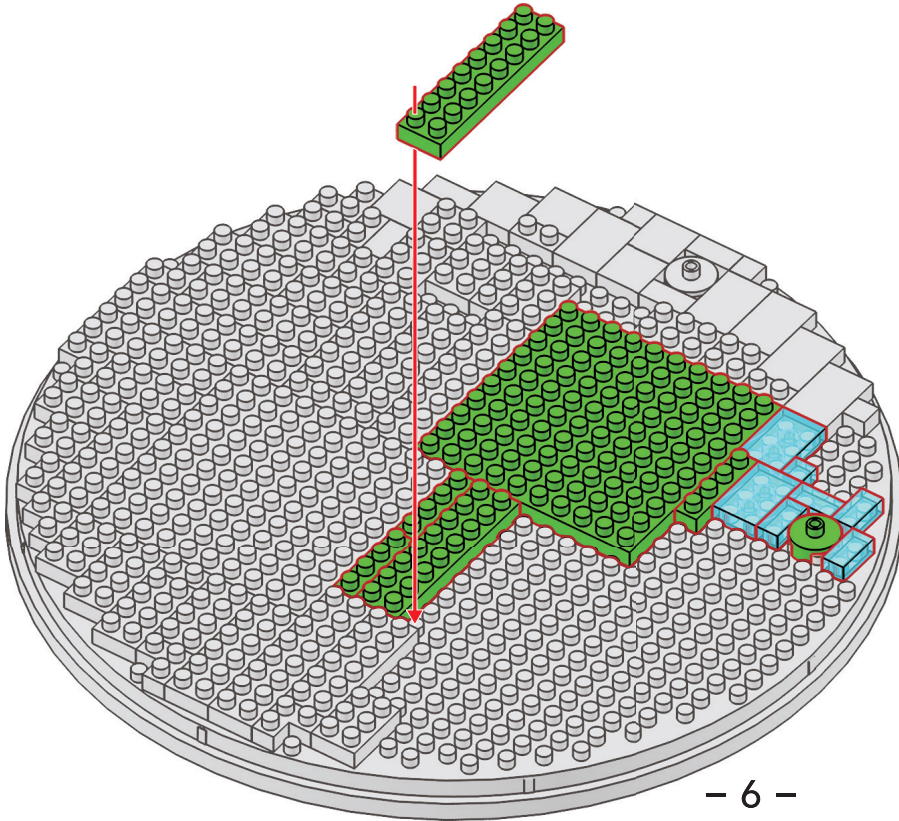
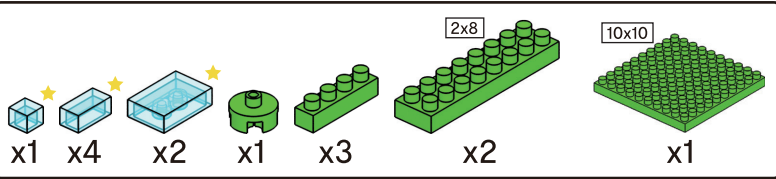

7

- x1 [Grey 1x1 Pin]
- x1 [Green 1x1 Pin]
- x5 [Grey 1x2 Technic Brick]
- x1 [Green 1x2 Round Technic Plate]
- x1 [Green 1x2 Technic Brick]
- x1 [Green 1x2 Technic Brick]
- x1 [Transparent 1x1 Technic Brick]
- x1 [Transparent 1x2 Technic Brick]
- x5 [Transparent 1x2 Technic Brick]
- x1 [Transparent 1x2 Technic Brick]
- x1 [Transparent 1x2 Technic Brick]
- x1 [Transparent 1x2 Technic Brick]

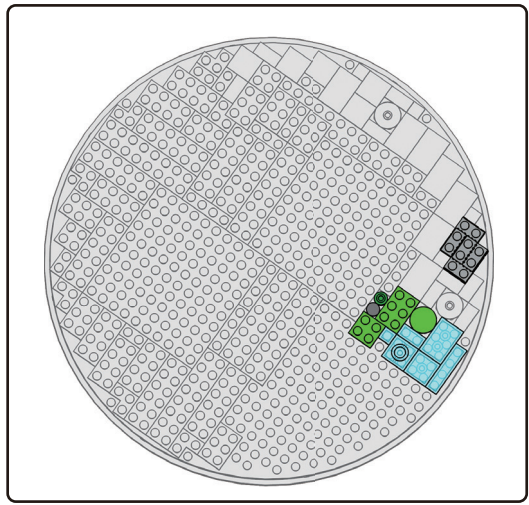
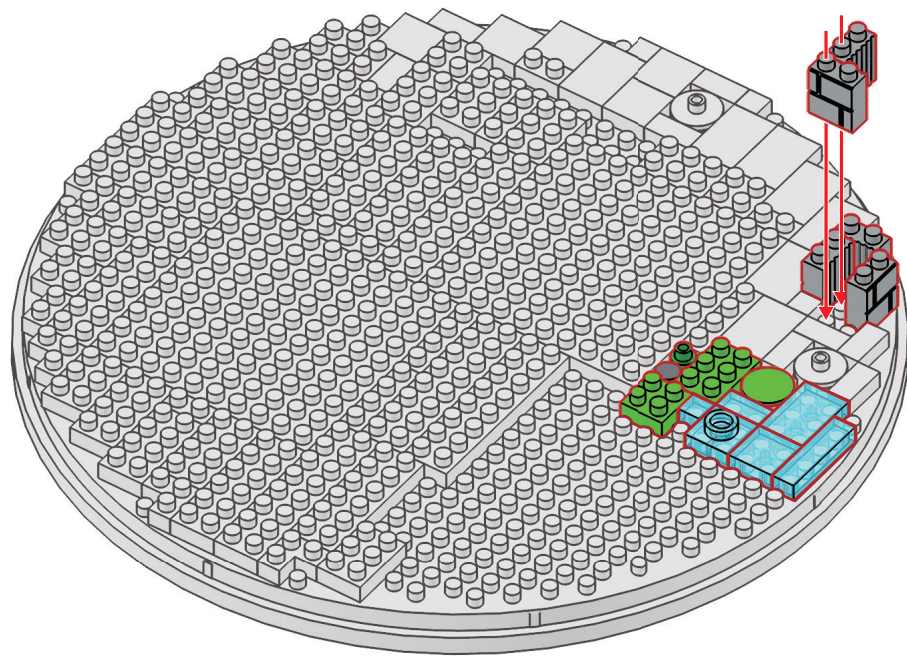



8

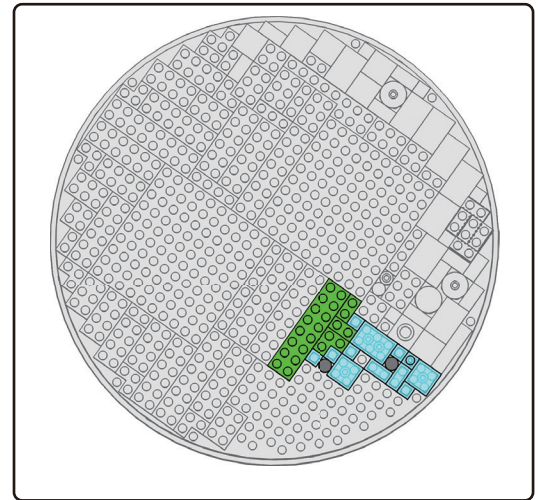
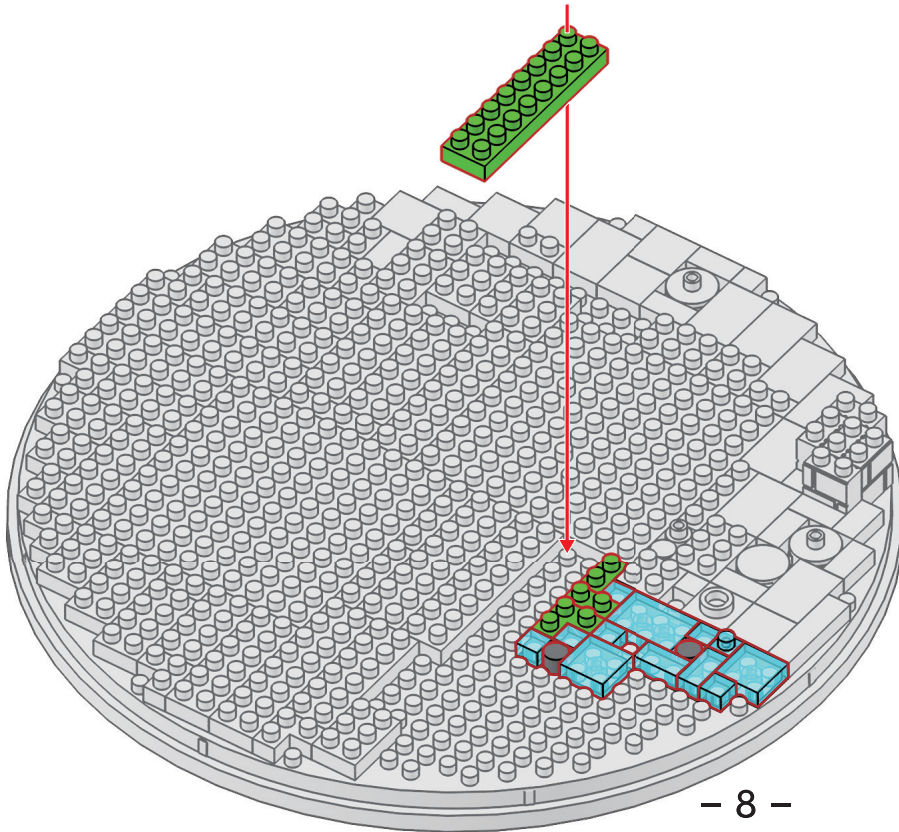
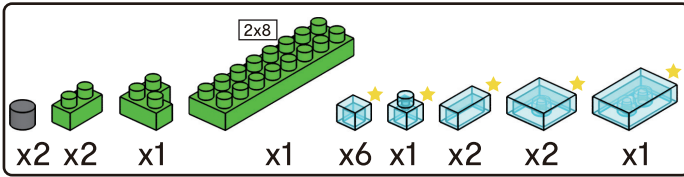

9

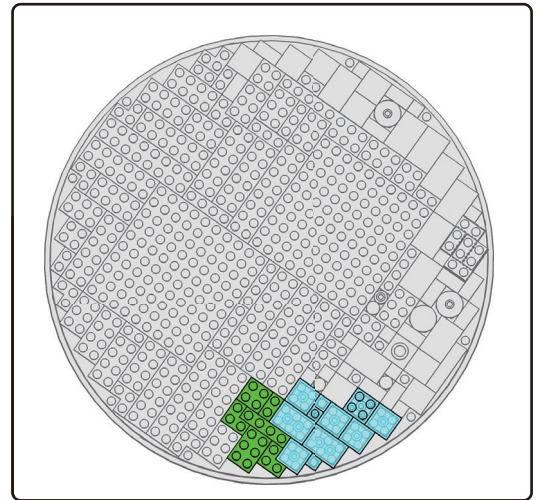
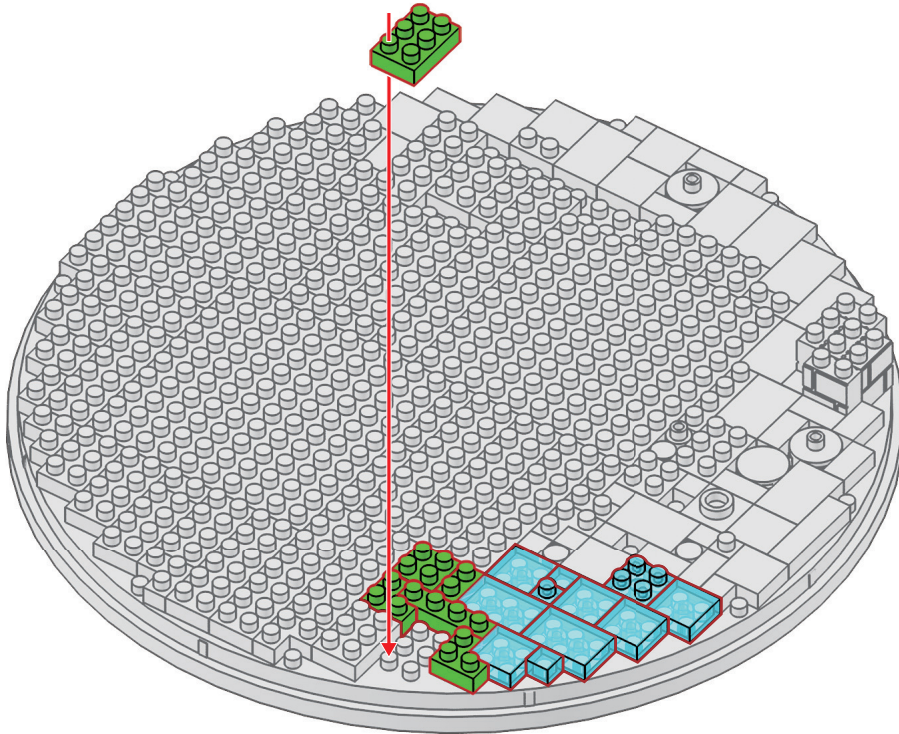
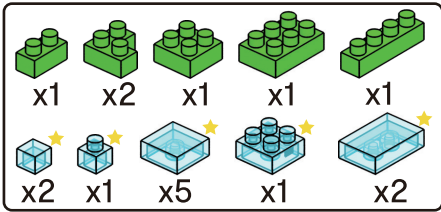

10

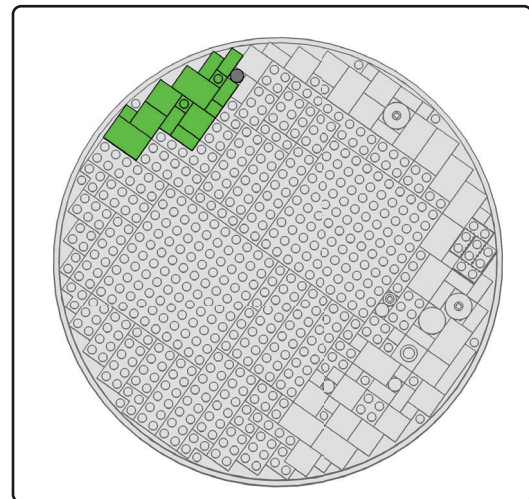
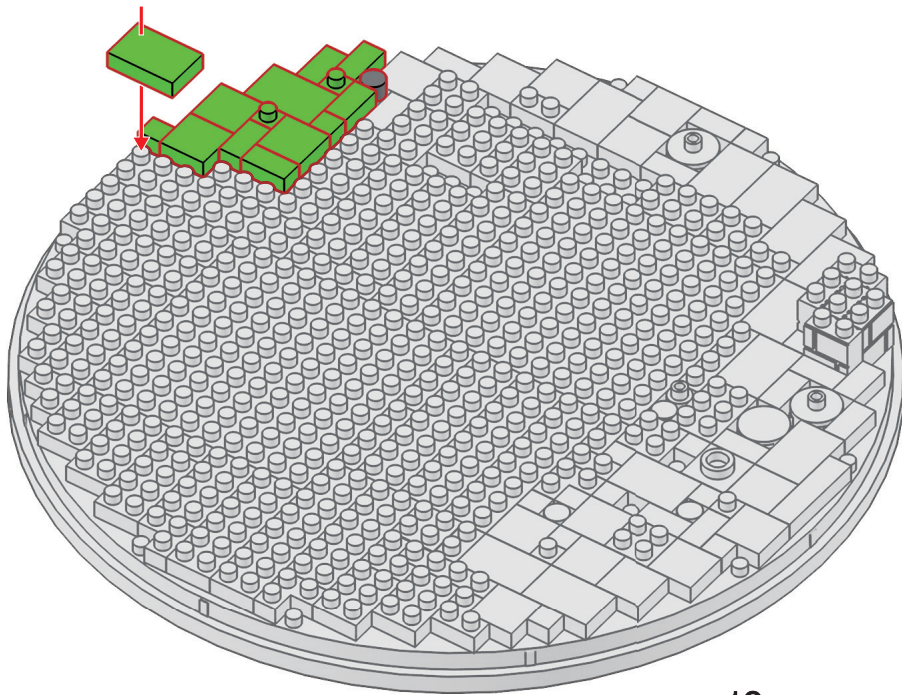
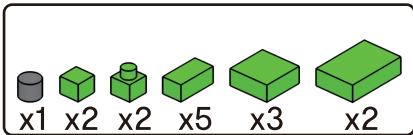

11

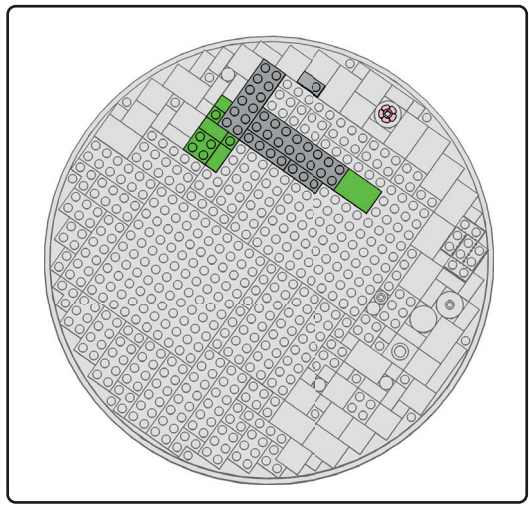
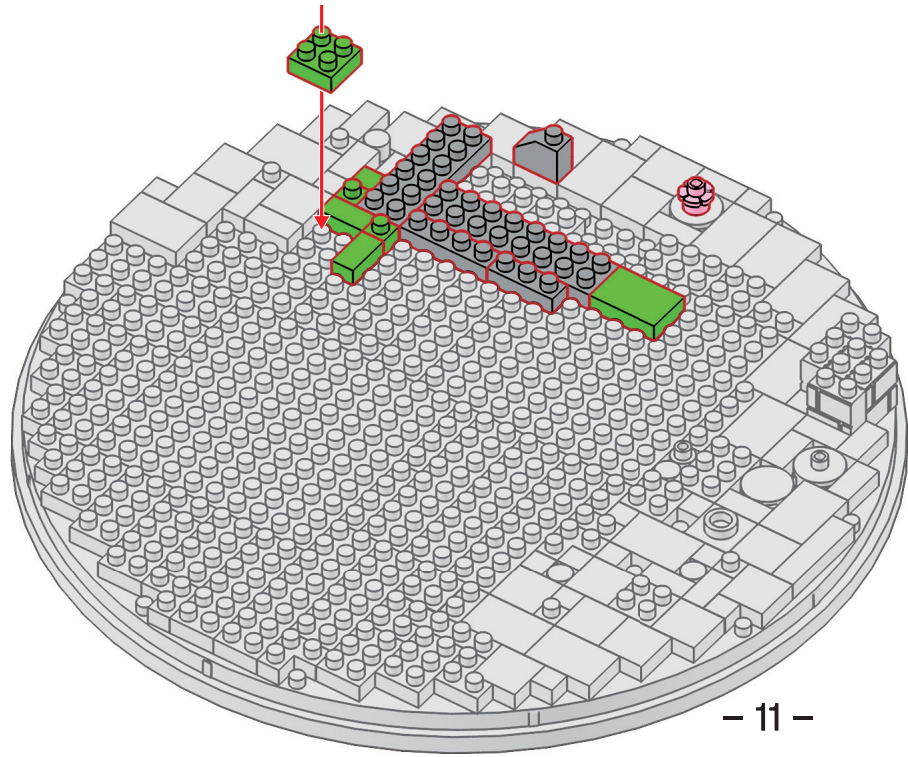
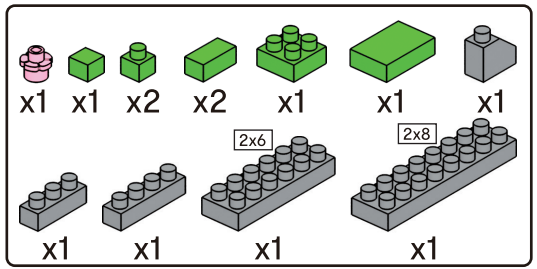

12

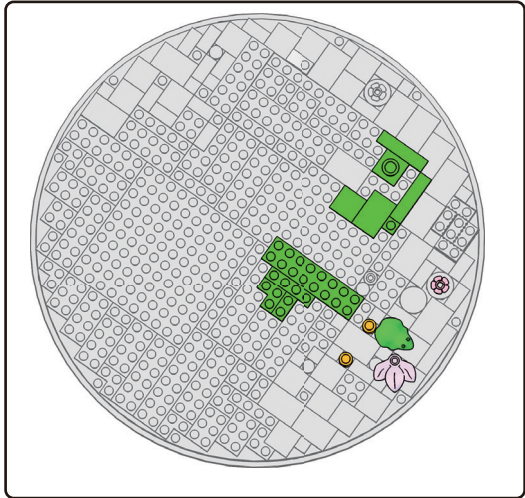
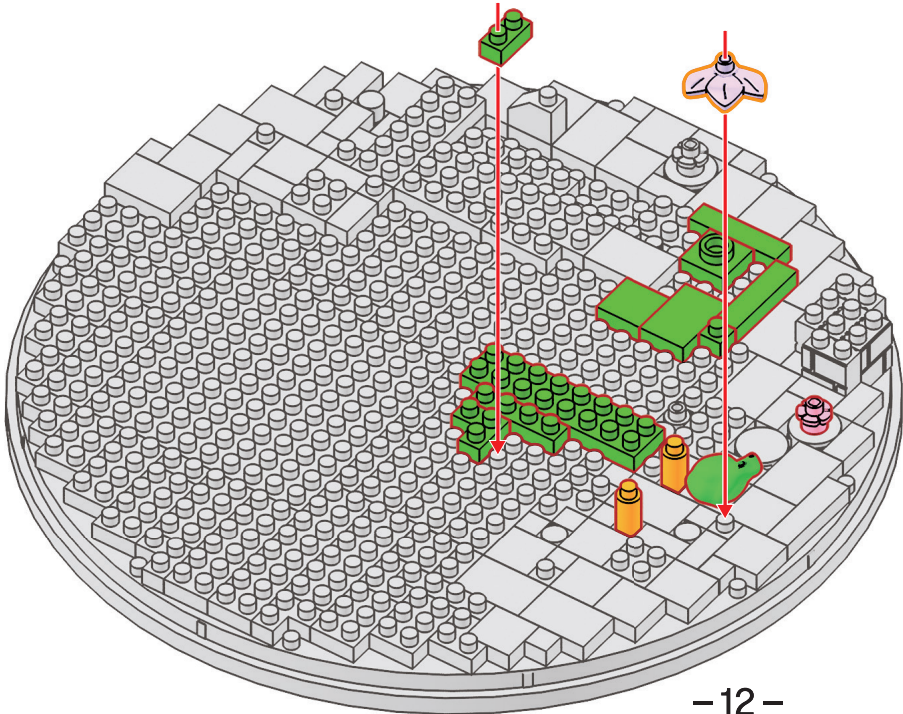
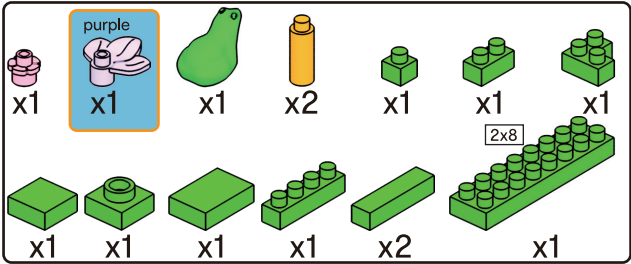

13

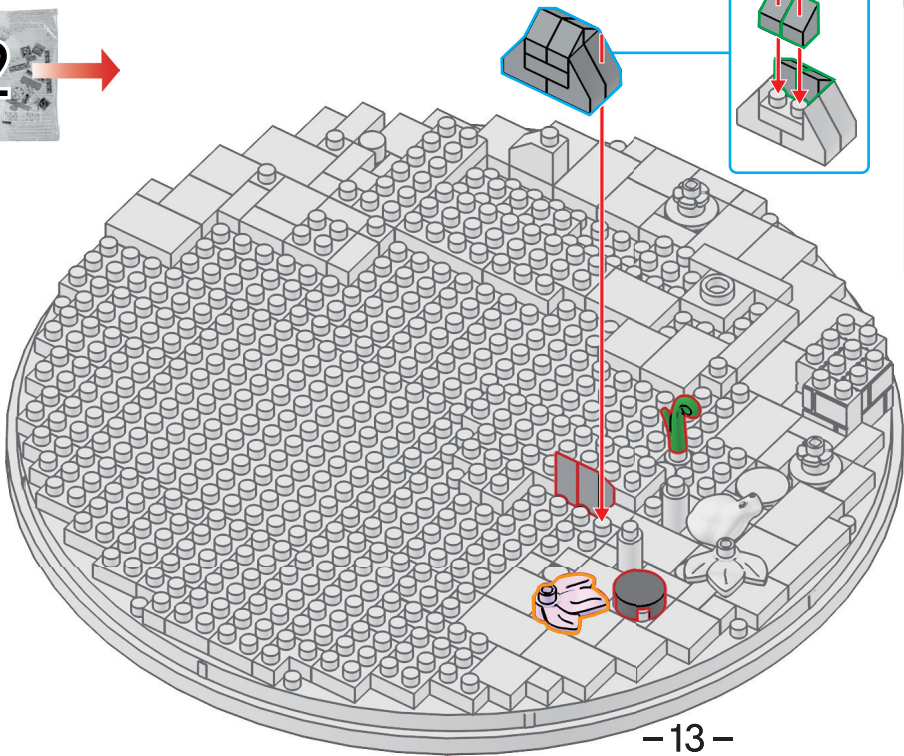
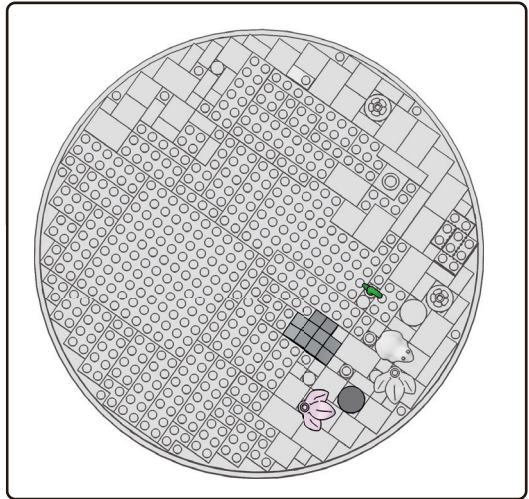
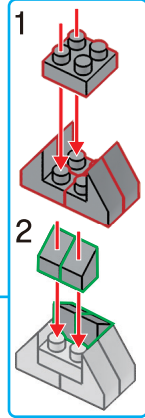
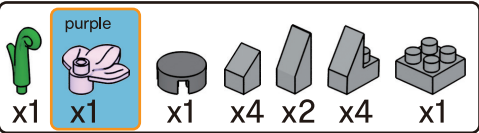

14

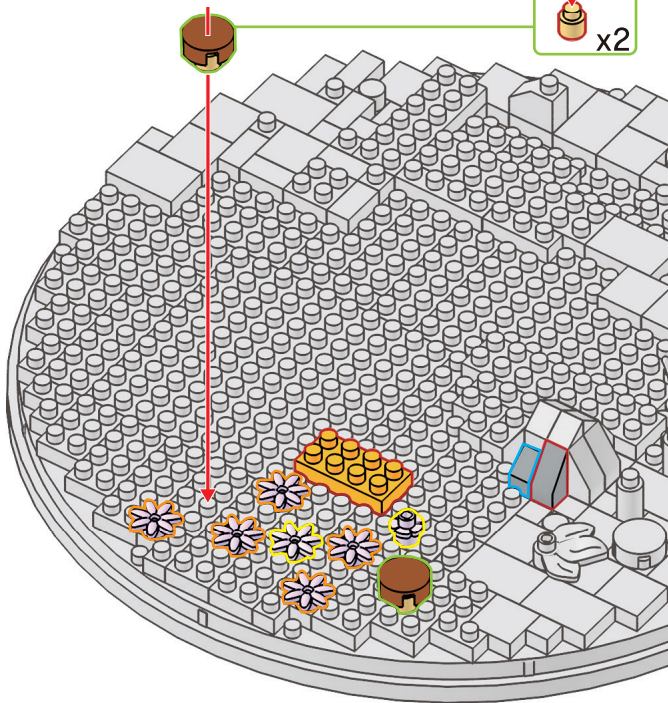
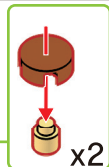
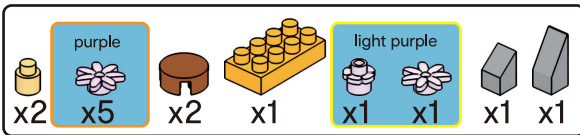

15

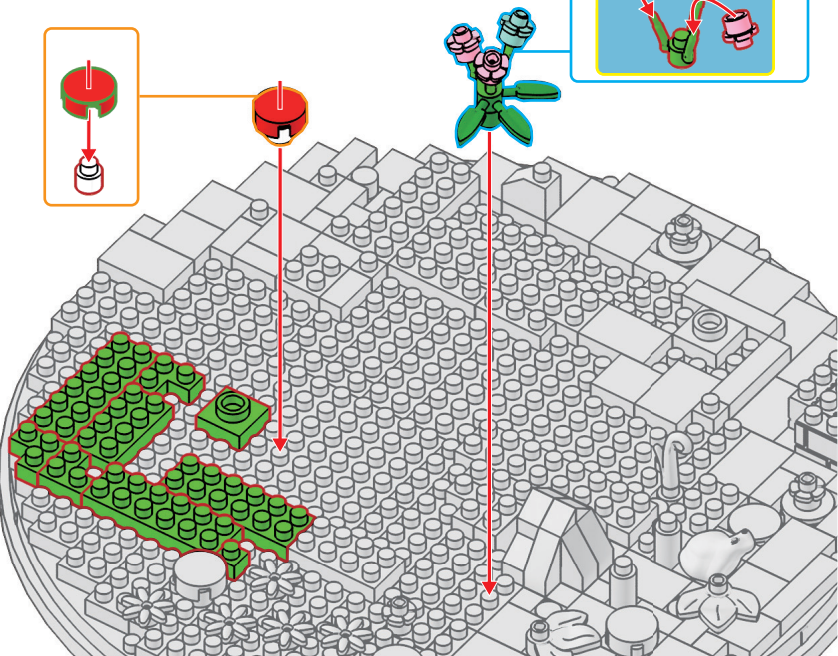
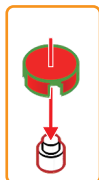
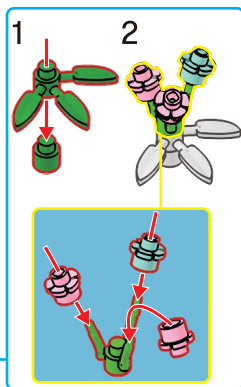
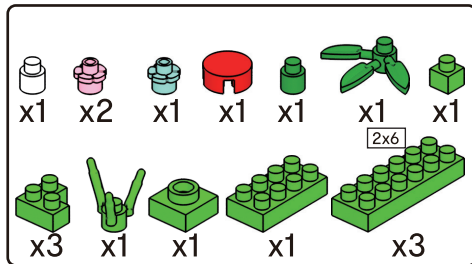

16

- x1
- x2
- x2
- x1
- x1
- x1
- x1
- x2
- x1
- x3
- x1

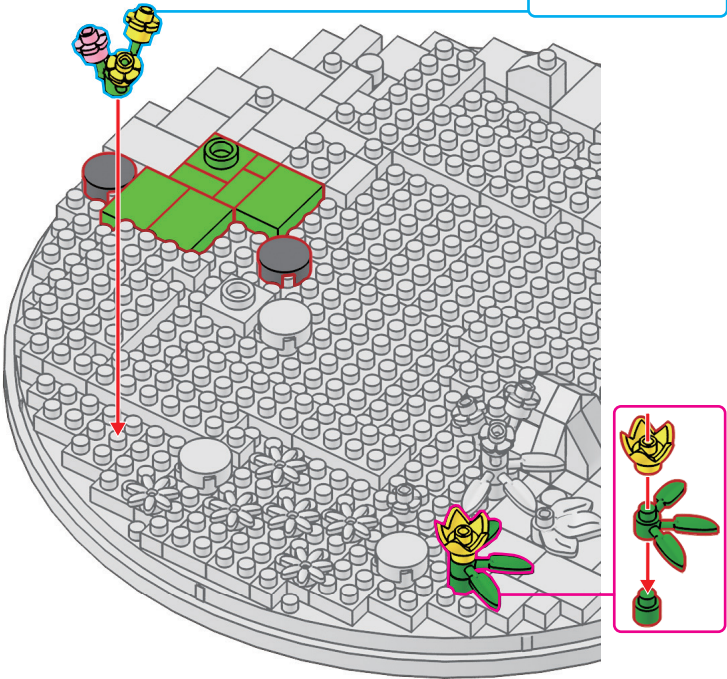
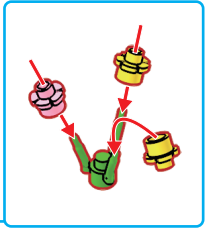

17

- x1
- x3
- x1
- x2
- x1
- x2
- x1
- x1
- x1

- x3

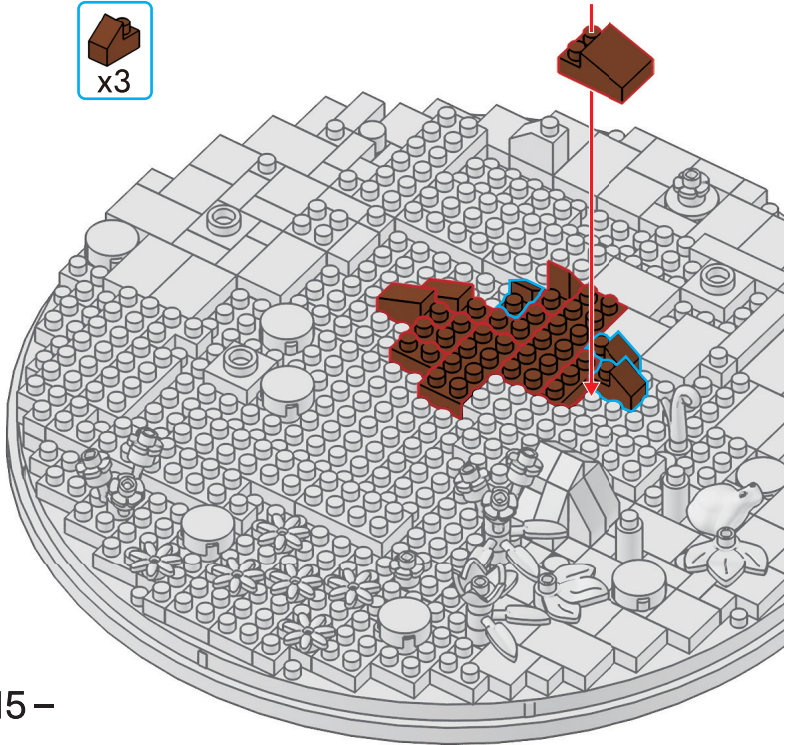



18

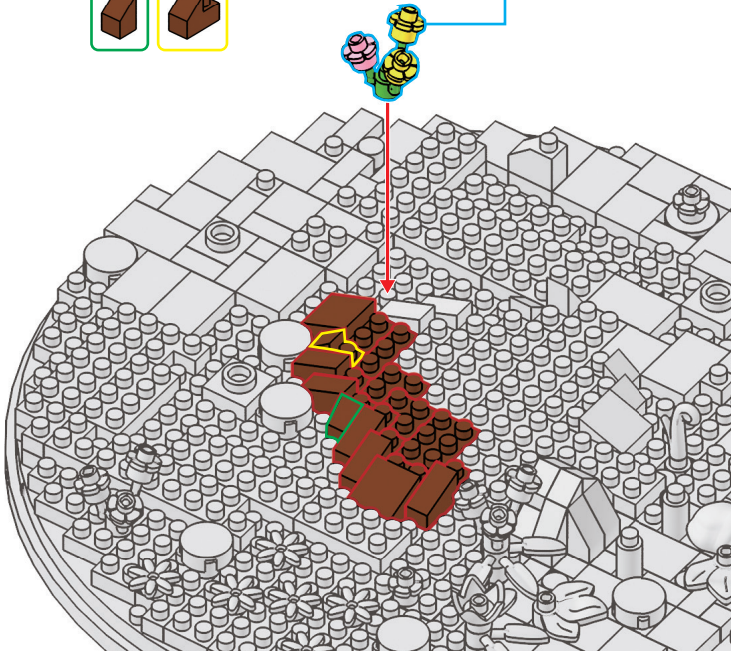
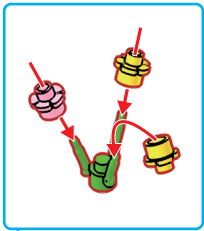
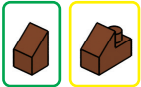
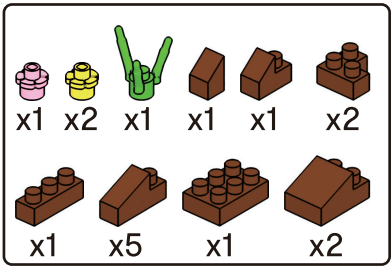

19

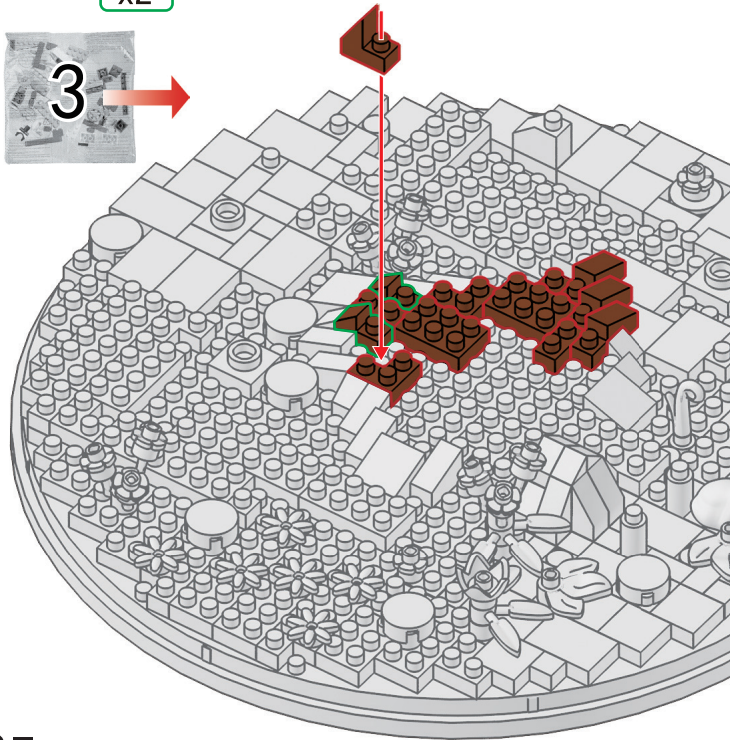
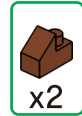
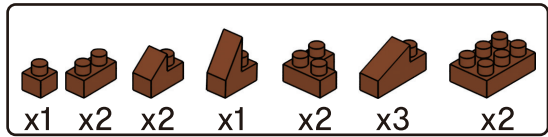

20

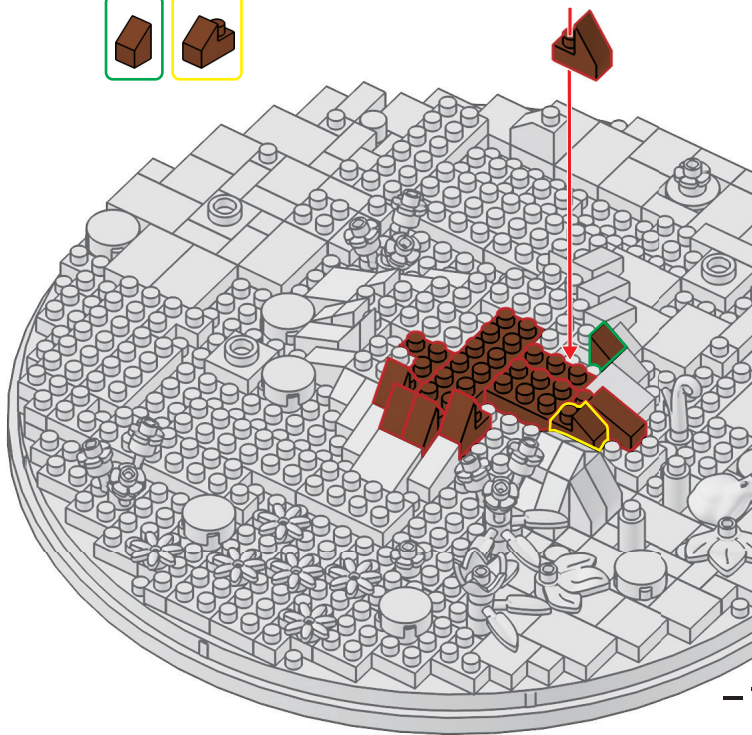
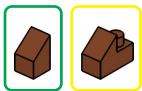
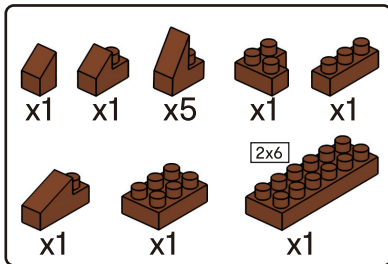

21

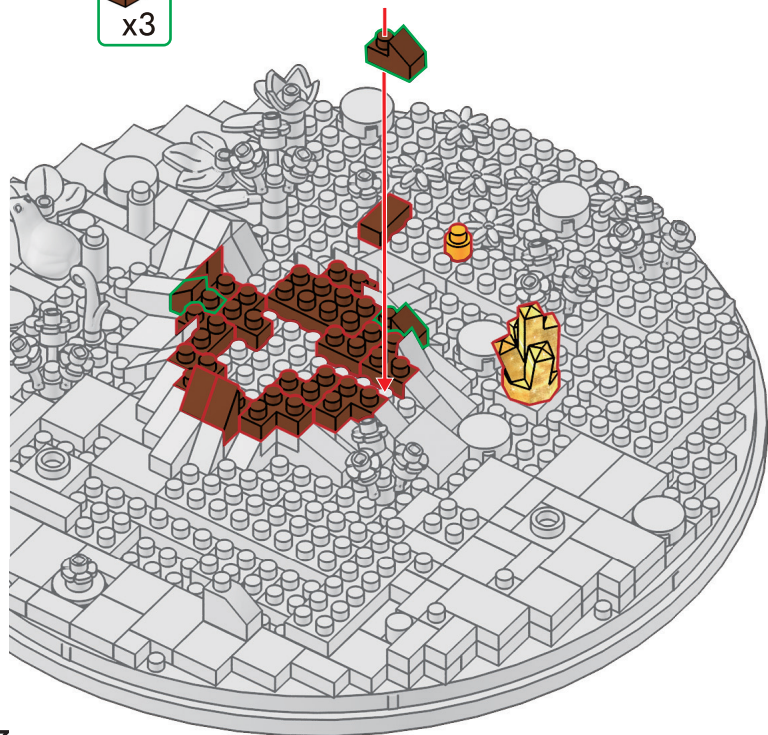
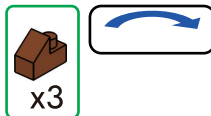
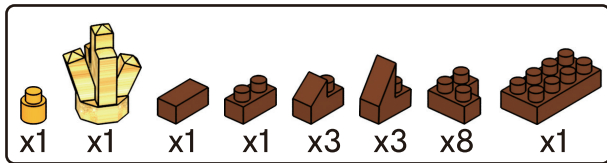

22

- x4
- x2
- x2
- x1
- x1
- x1
- x4
- x2
- x1

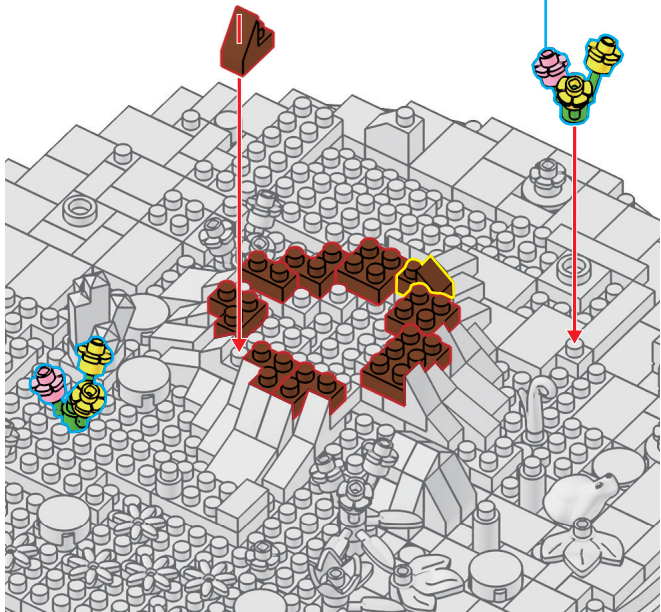
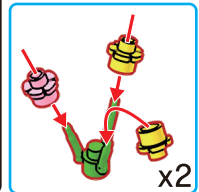

23

- x1
- x1
- x1
- purple**  
x1
- x1
- x1
- x1
- x1
- x4
- x4
- x2
- x1

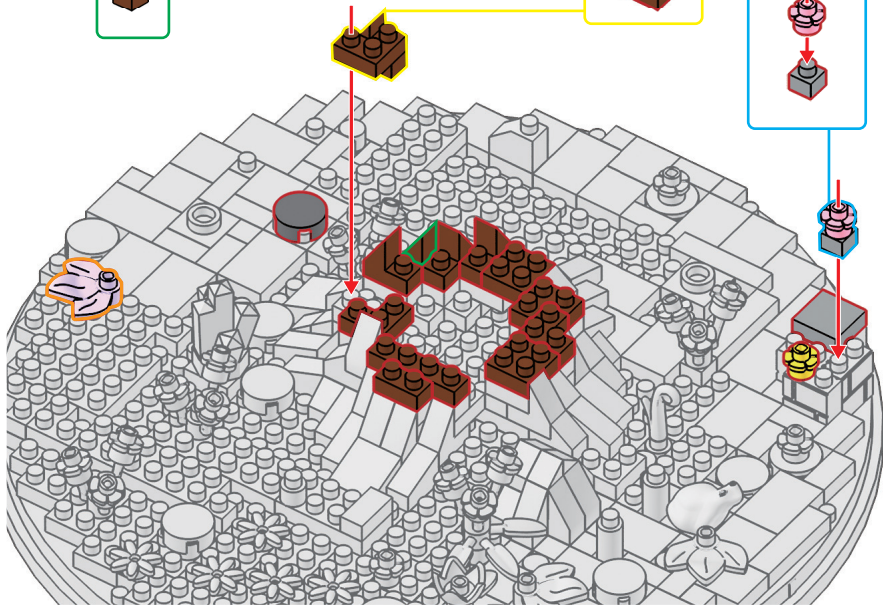
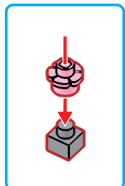
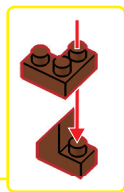
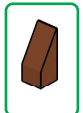

24

- x1
- x1
- x1
- x1
- x1
- x1
- x2
- x4
- x3
- x1
- x1

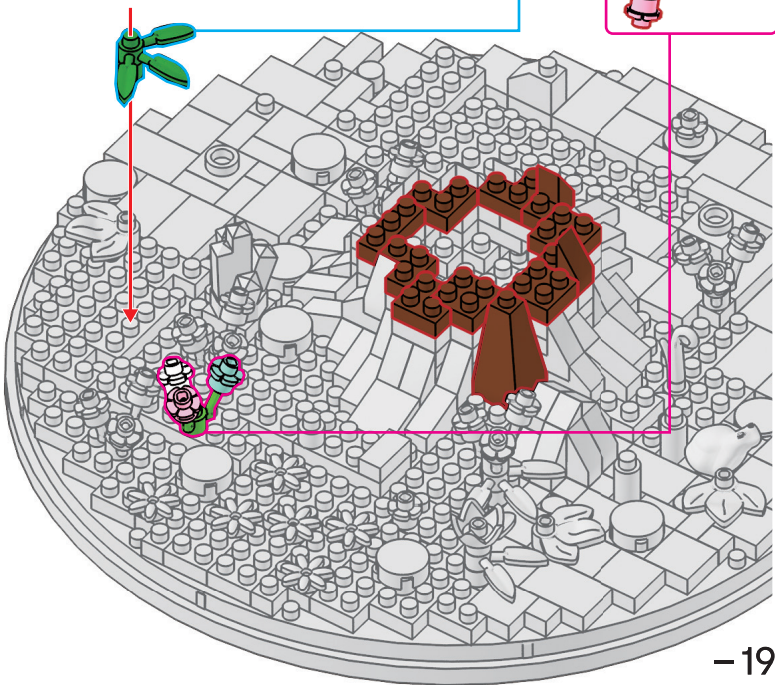
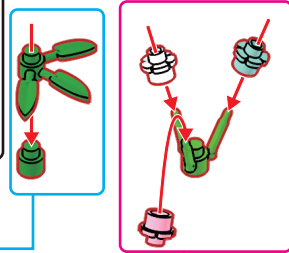

25

- x1
- x1
- x1
- x1
- x1
- x1
- x1
- x1
- x2
- x4
- x2
- x1
- 

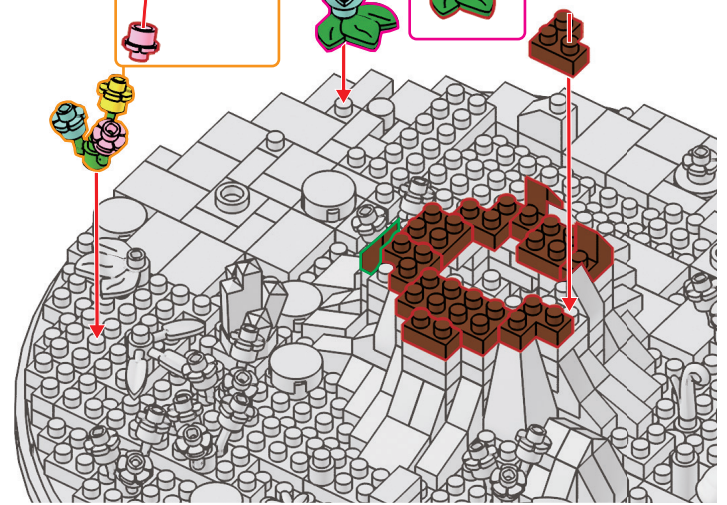
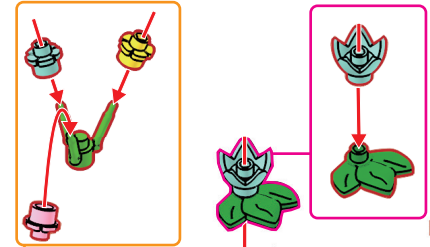

26

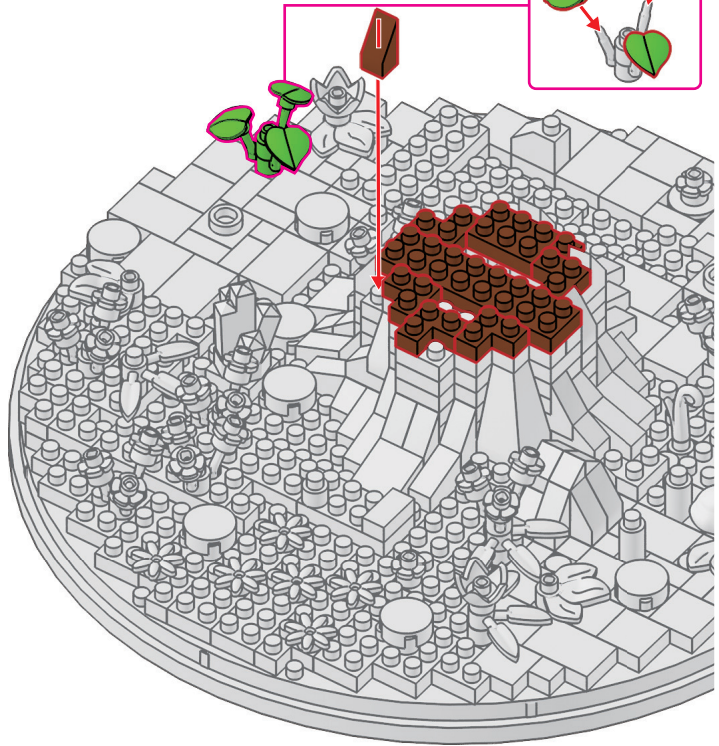
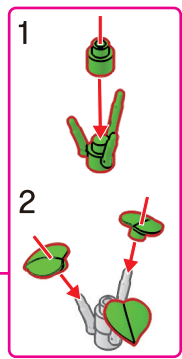
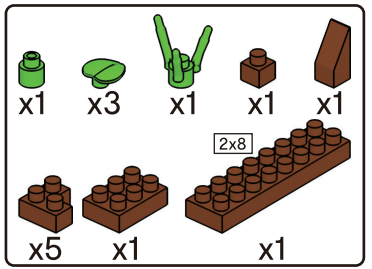

27

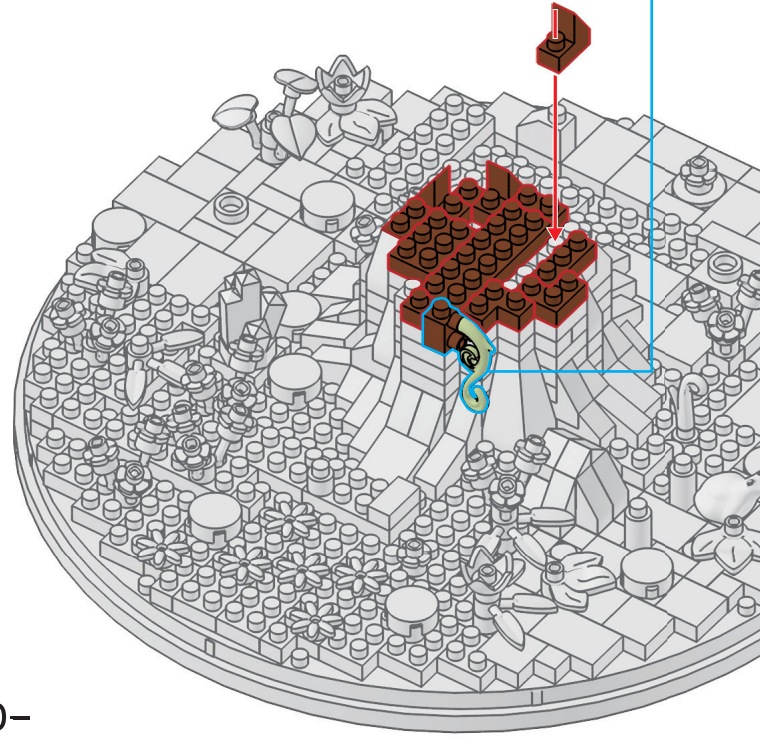
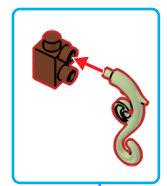
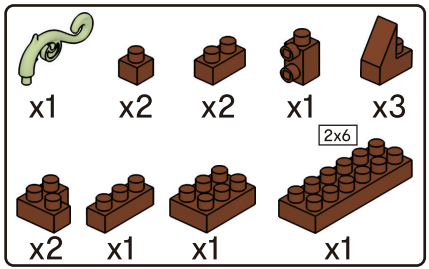





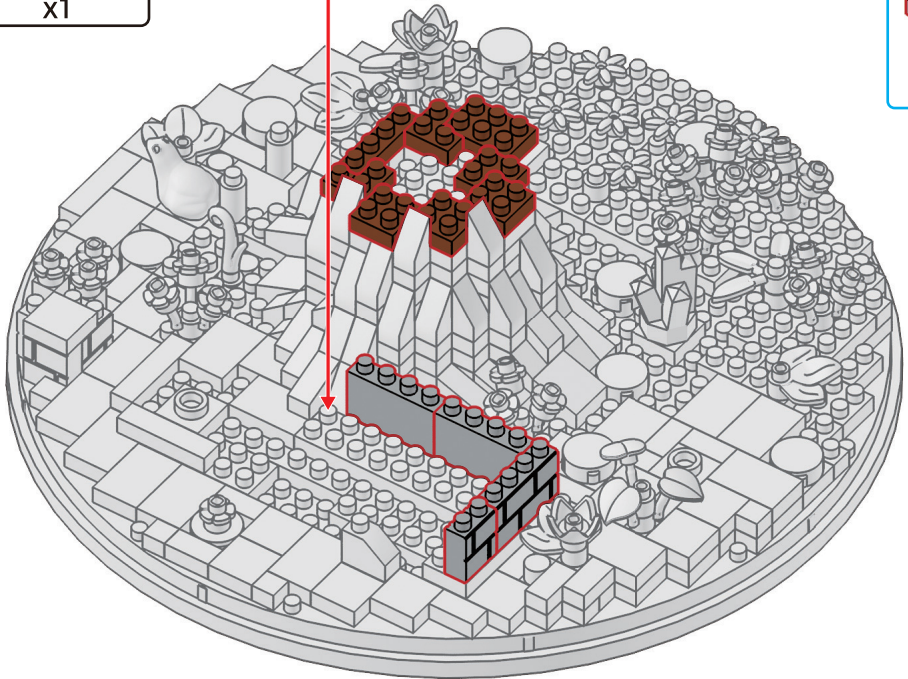
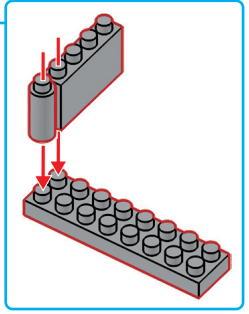
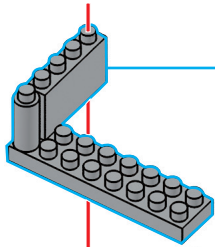



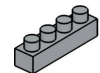

28

- x3
- x3
- x1
- x1
- x1
- x1
- x4
- x1

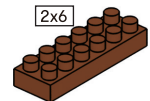

29

-  x1
-  x1
-  x2
-  x1
-  x2
-  x2
-  x1
-  x3
-  x1
-  x1
-  x1
-  x1

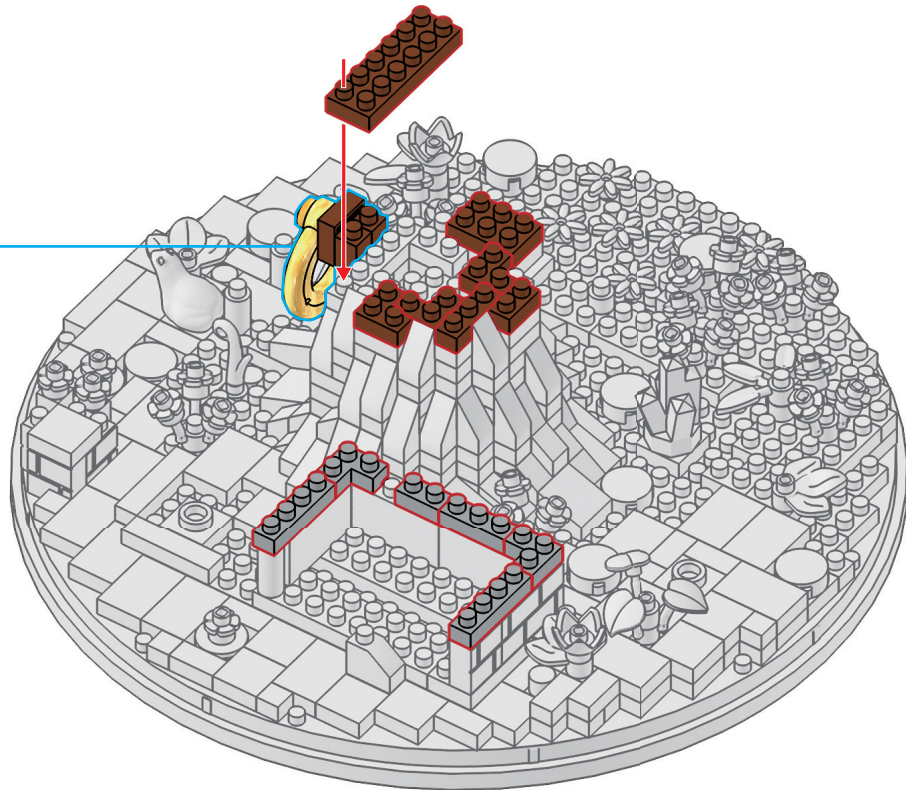
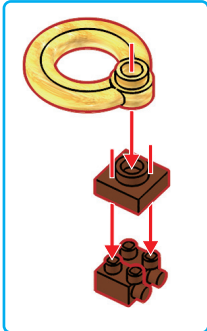

30

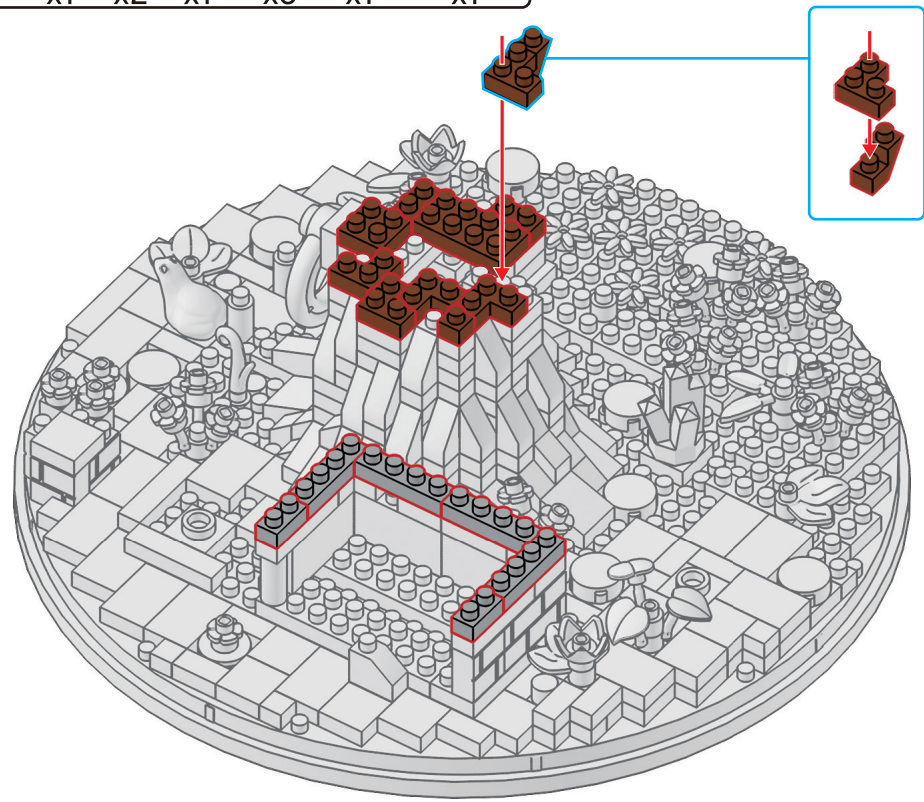
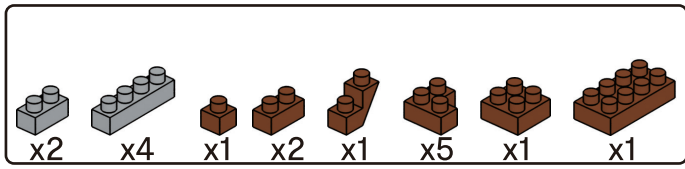



31

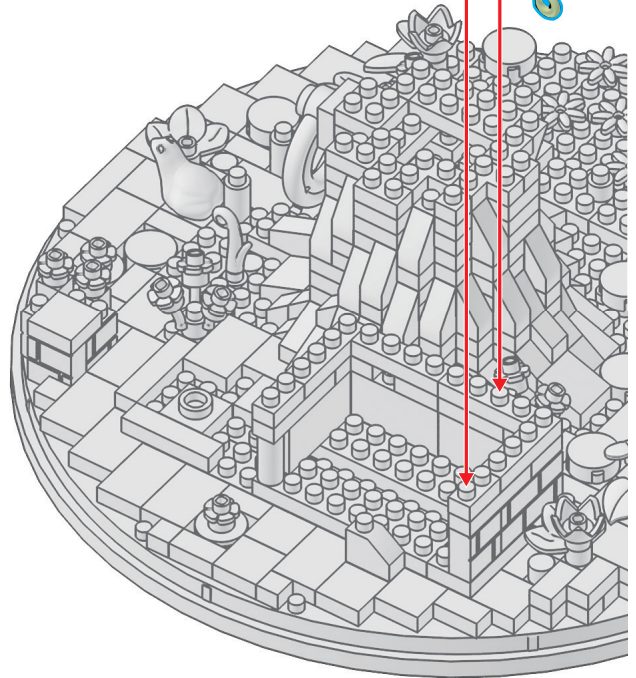
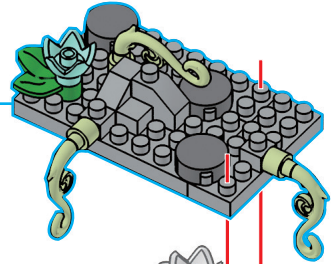
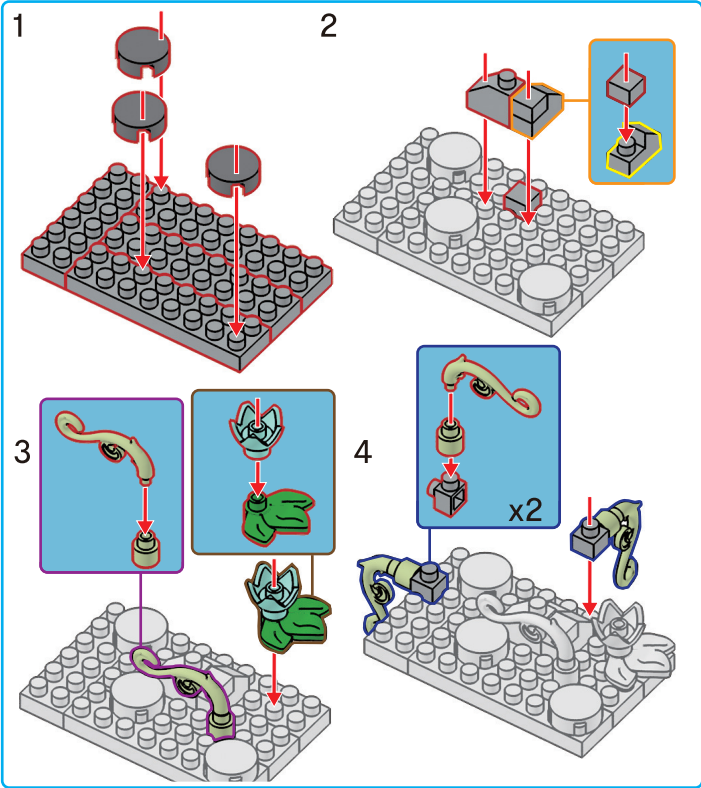
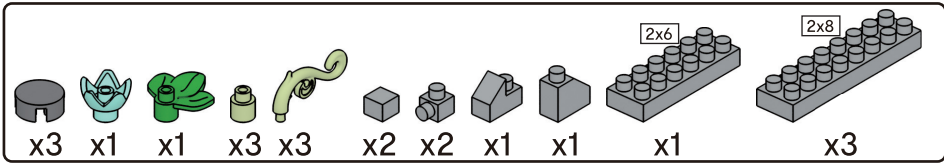





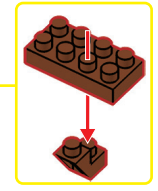
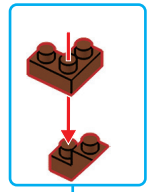
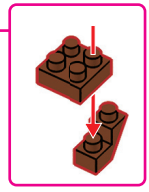
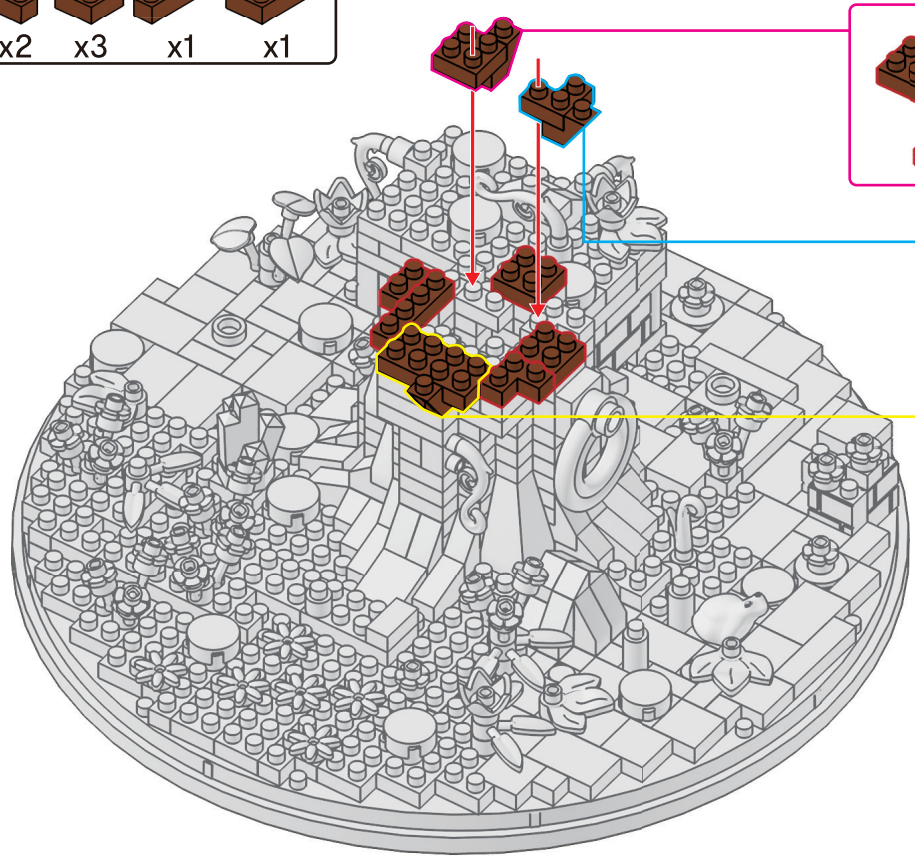

32

- x1
- x3
- x2
- x3
- x1
- x1





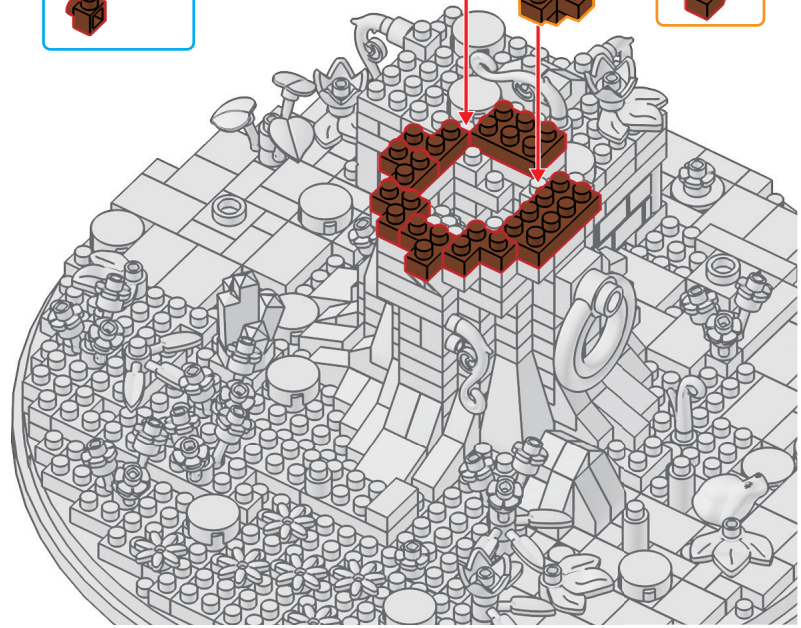
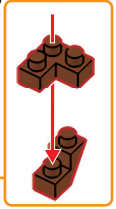
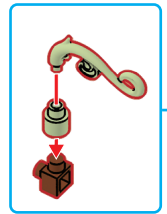

33

-  x1
-  x1
-  x1
-  x1
-  x6
-  x1
-  x1

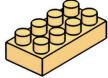

34

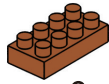
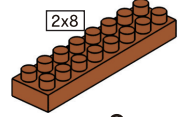
-  x2
-  x2
-  x1
-  x2
-  x2
-  x3
-  x2

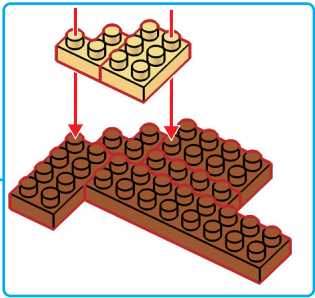
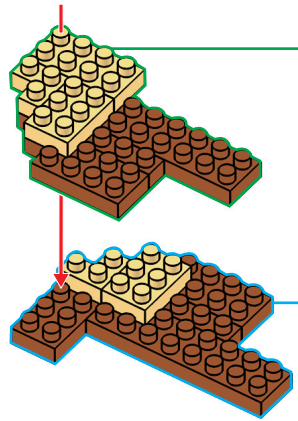
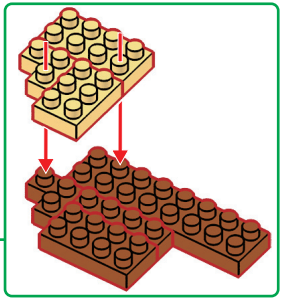

35

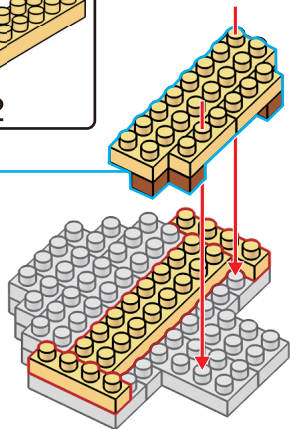
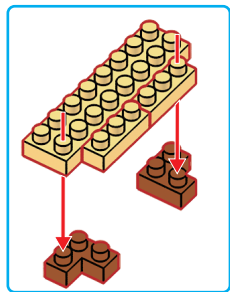
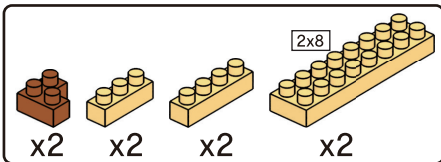

36

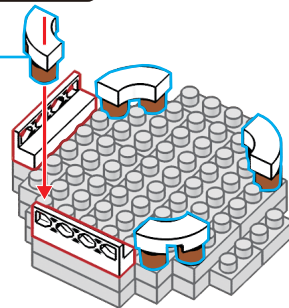
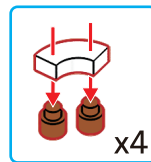
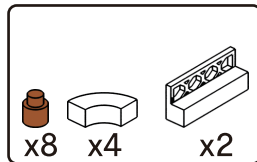

37

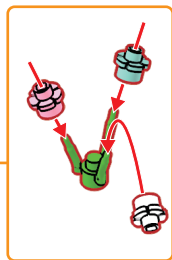
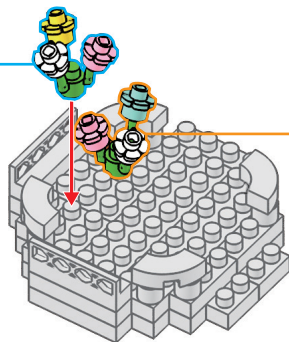
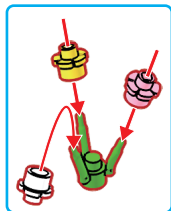
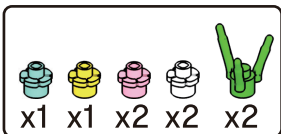

38

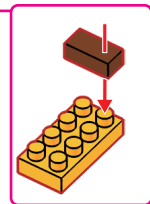
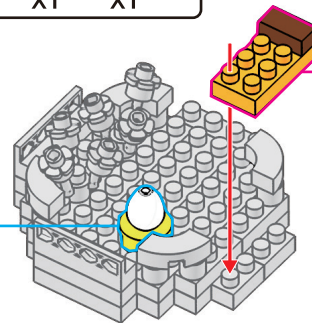
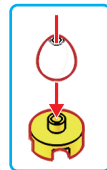
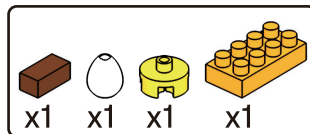

39

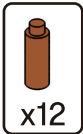

flip over

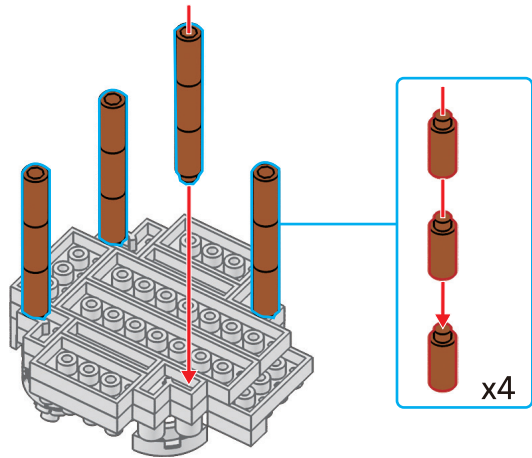

40

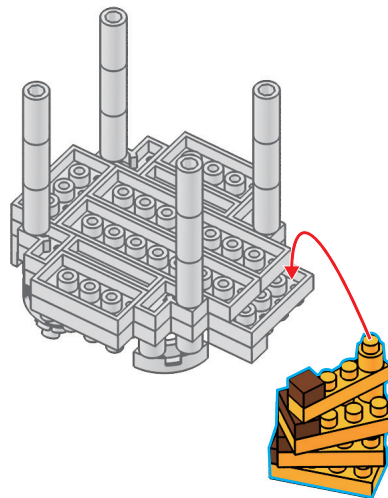
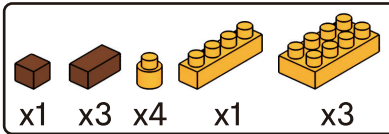

1

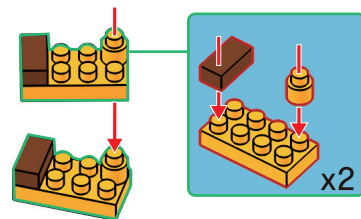

2

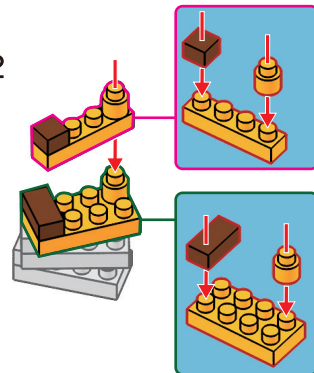

41

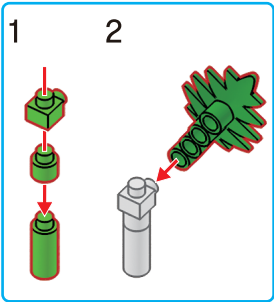
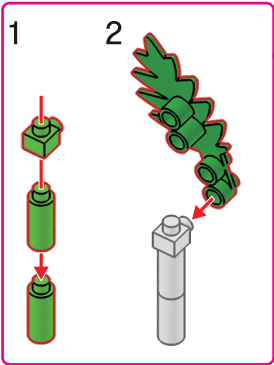
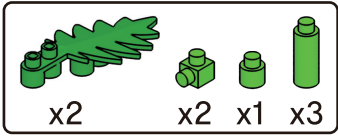

33

40

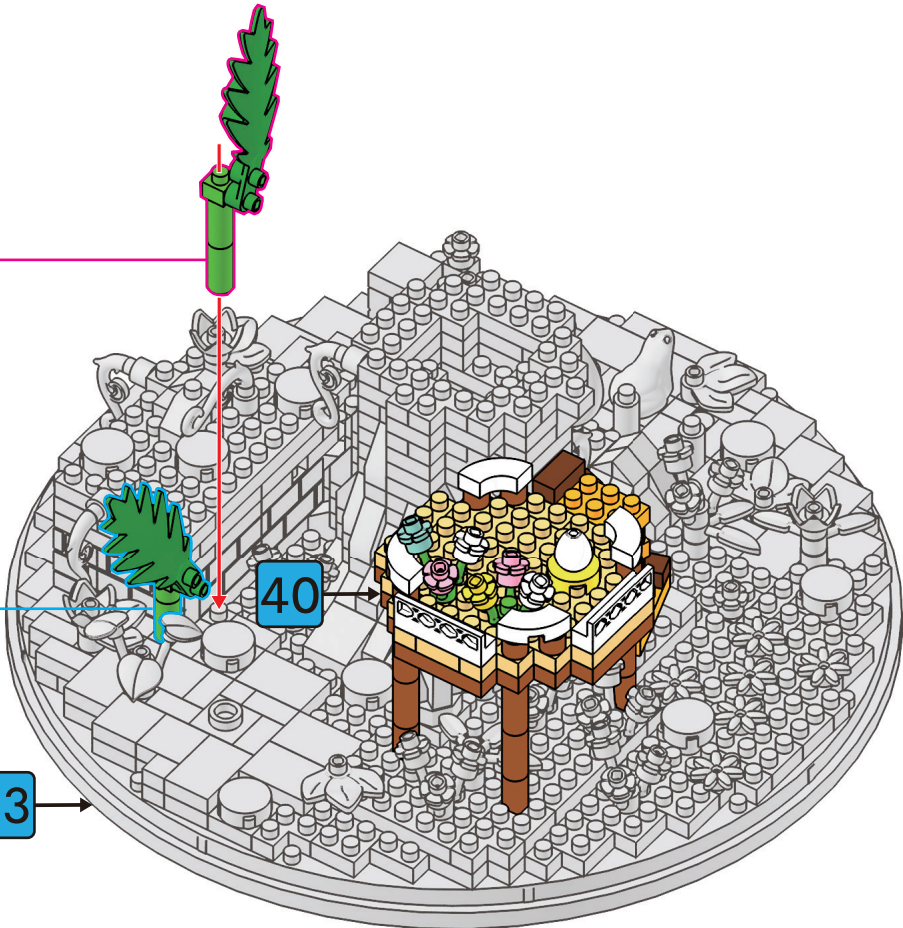

42

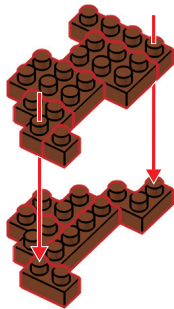
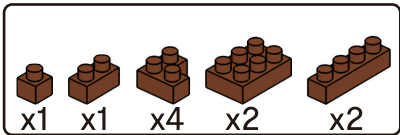

43

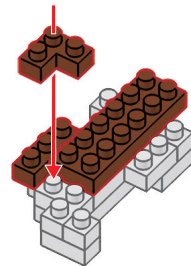
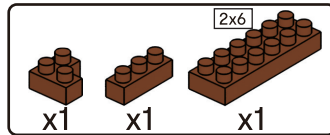

44

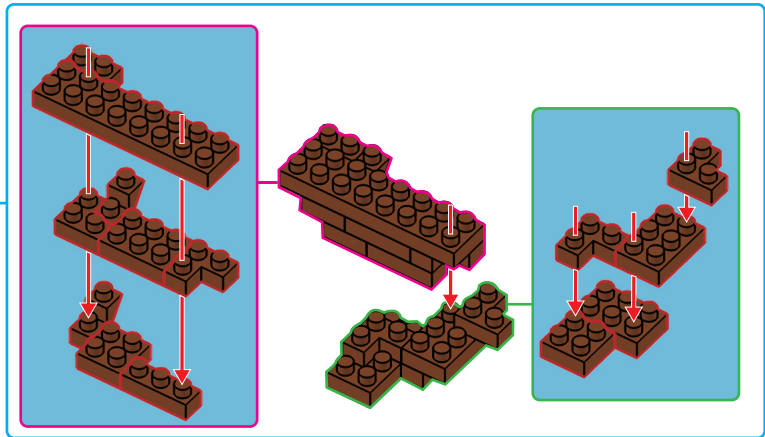
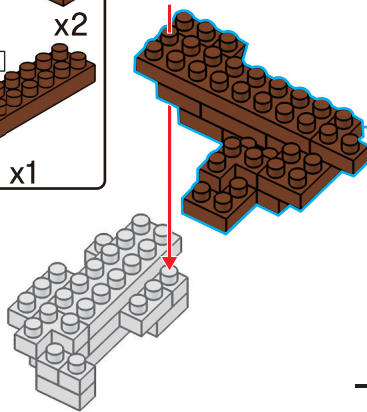
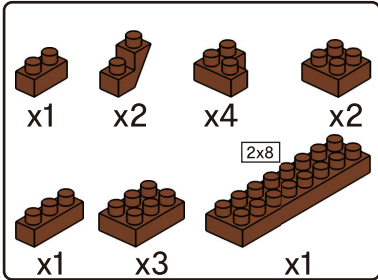

45

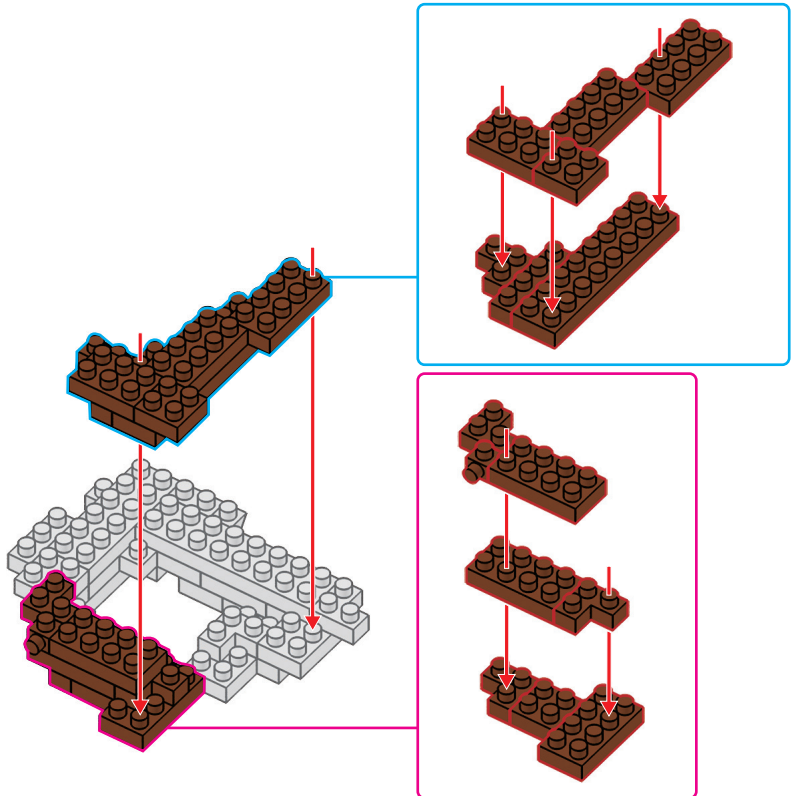
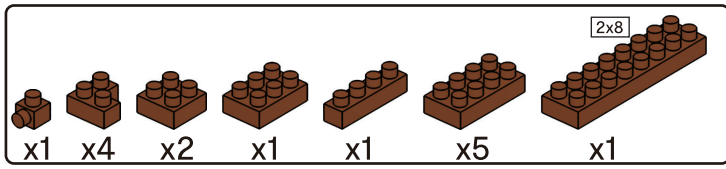

46

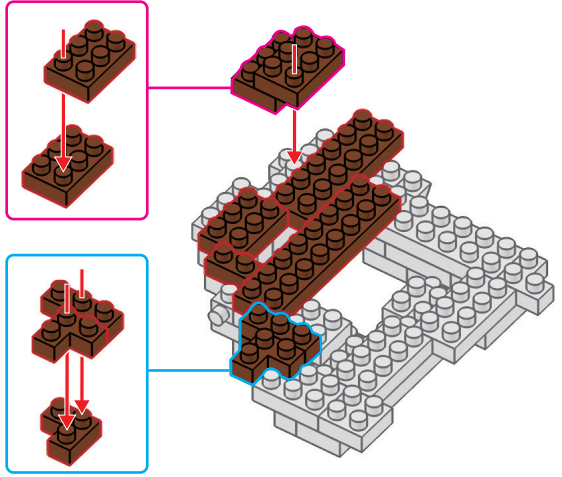
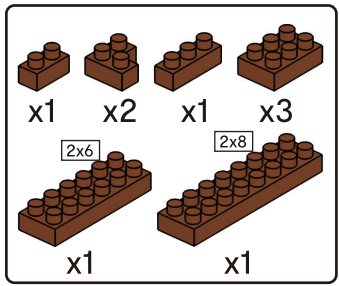



47

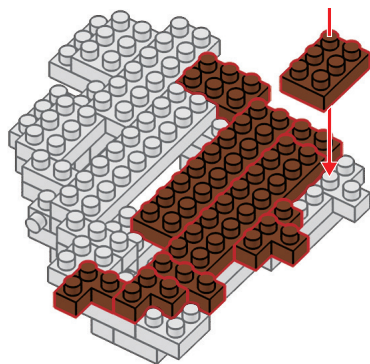
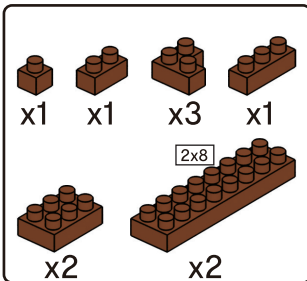

48

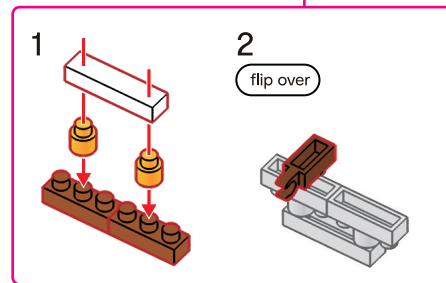
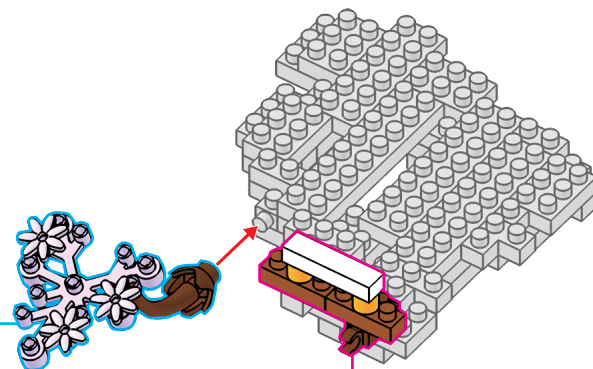
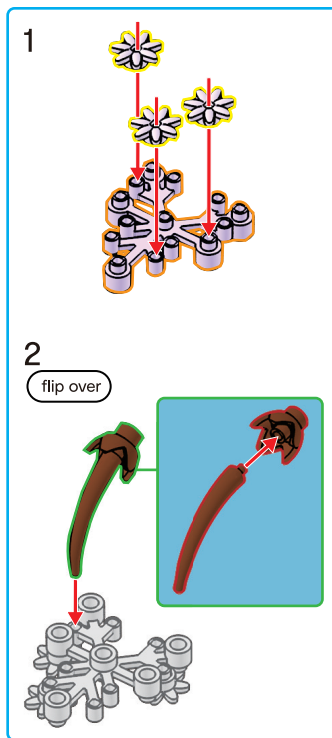
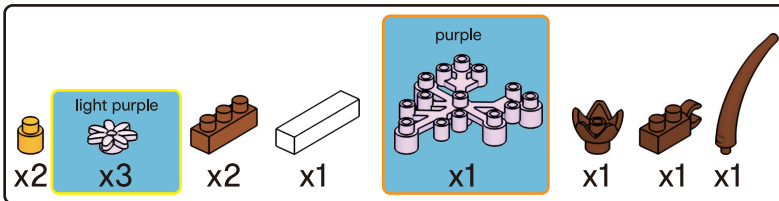

49

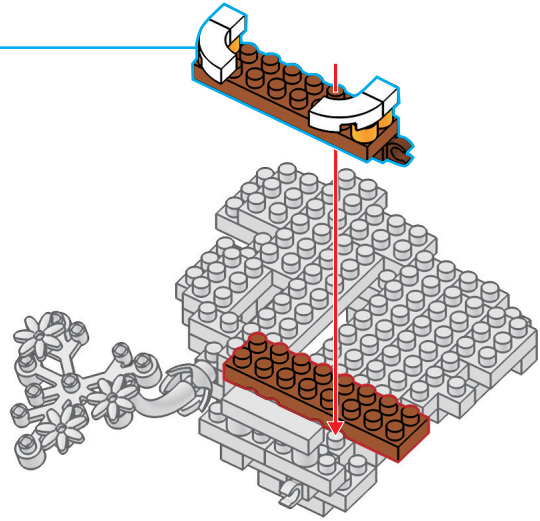
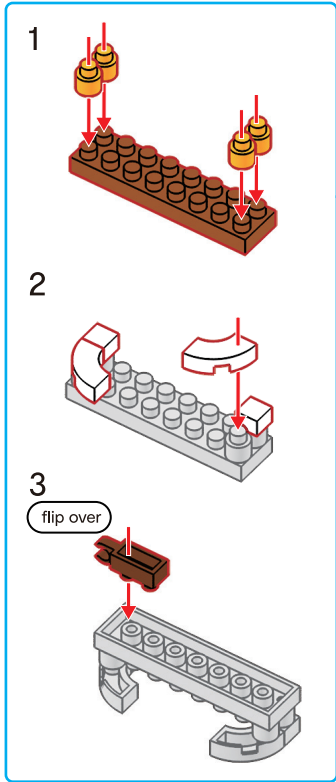
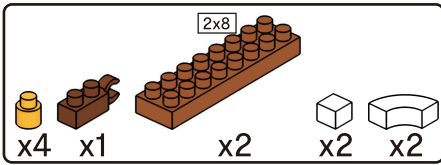

50

light purple  
x7

x2

purple  
x2

51

x1

x1

x1

x2

x1

1

2 flip over

1

2 flip over

52

light purple  
x2

purple  
x1

x1

x1

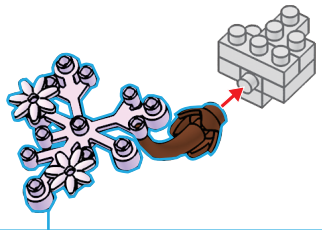

1

2

flip over

53

x1

x1

x1

x1

x1

x1

x1

52

50

54

light purple  
x2

x1

purple  
x1

x1

x1

2x6  
x2

2x8  
x1

1x10  
x1

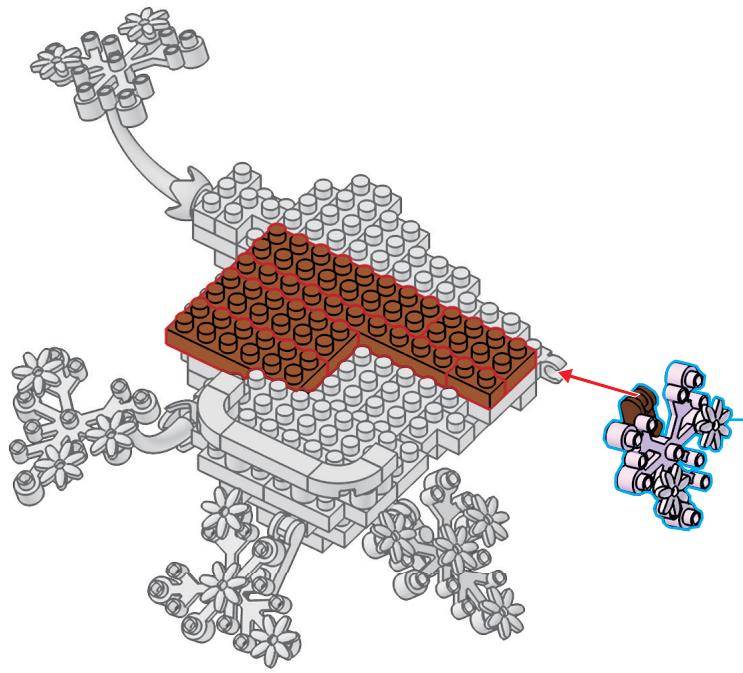

1

2  
flip over

Step 1 shows a purple flower-like structure with a brown brick on top. Step 2 shows the same structure flipped over, with the brown brick now on the bottom. Red arrows indicate the direction of assembly.

55

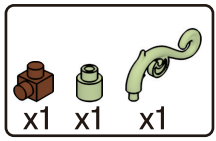

flip over

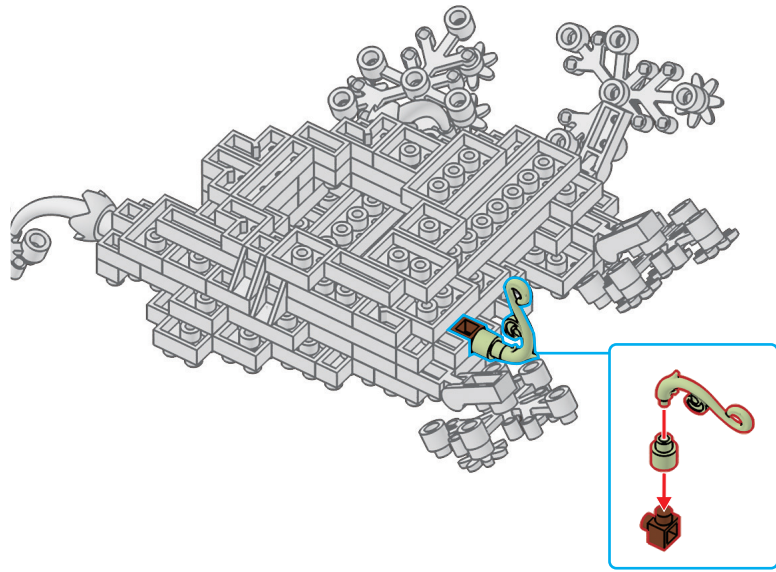

56

flip over

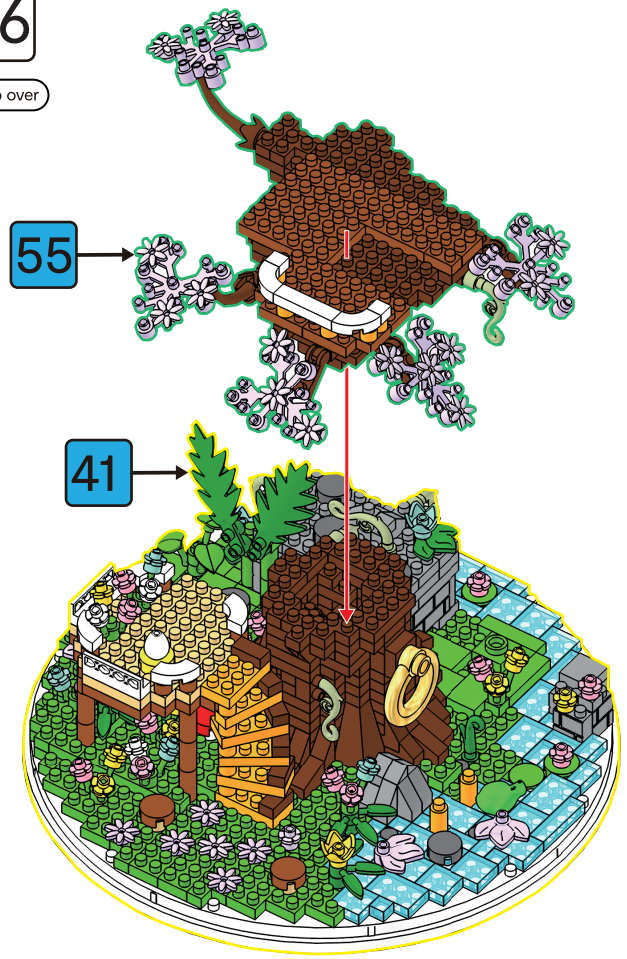

57

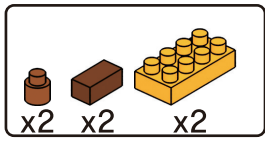

58

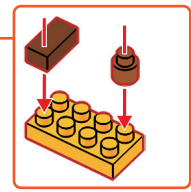
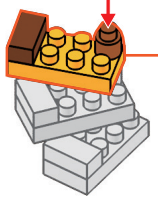
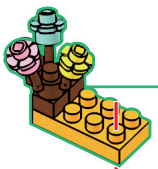
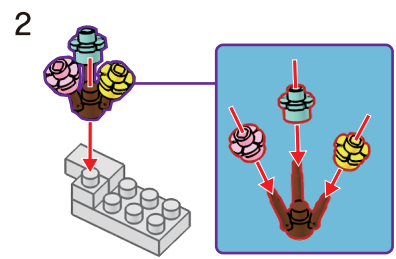
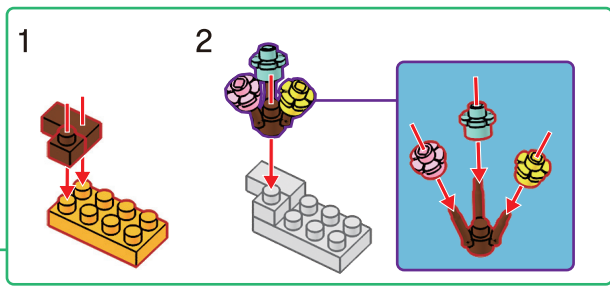
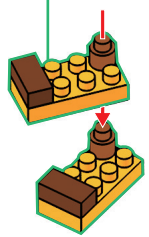
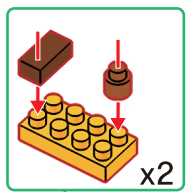
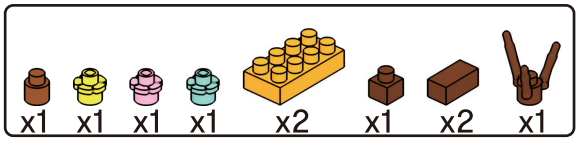

59



58

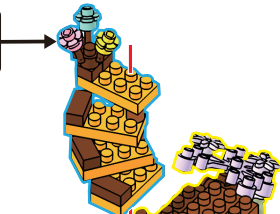

56

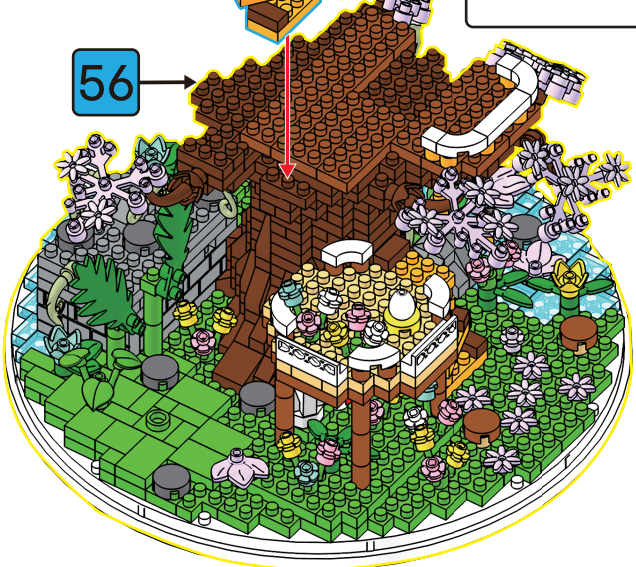

60

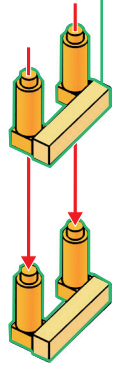
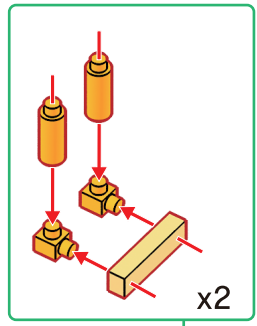
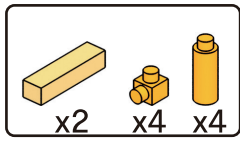



61

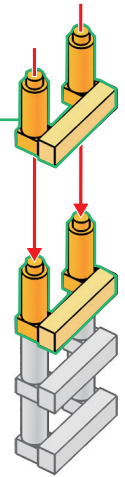
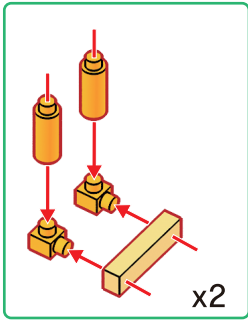
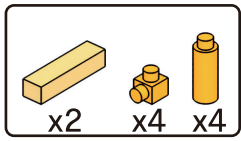

62

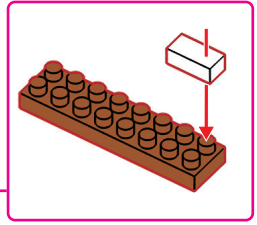
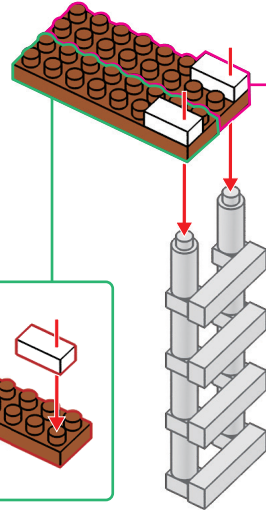
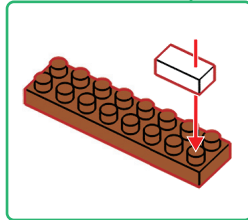
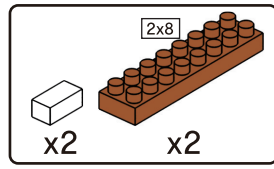

63



62



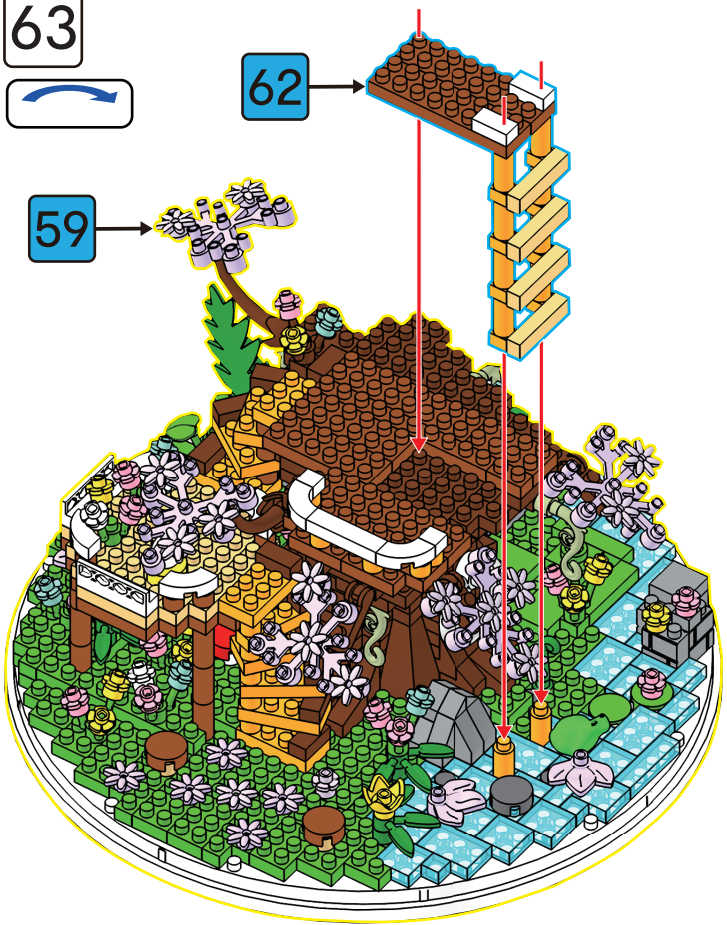



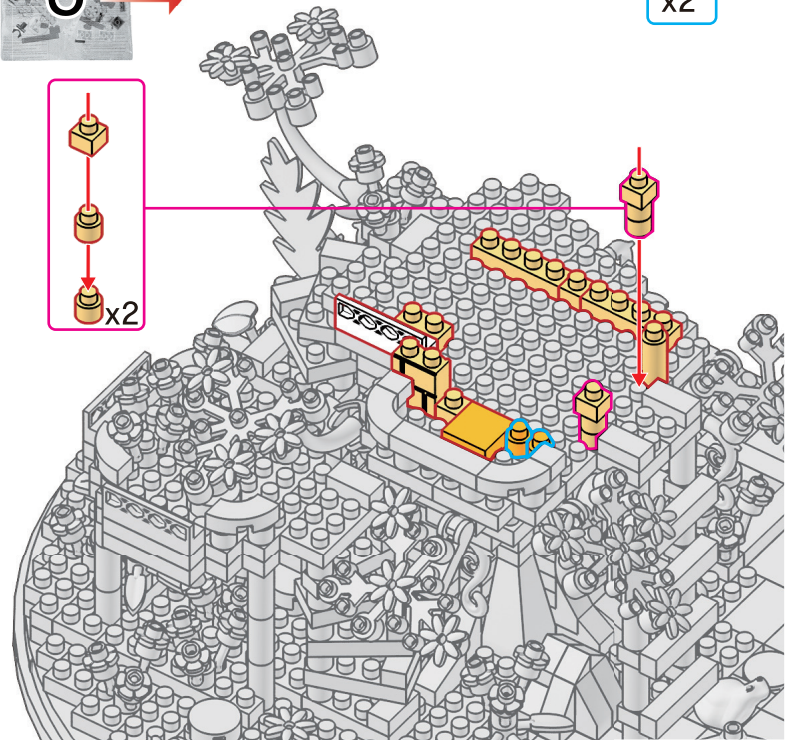
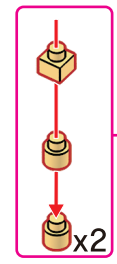
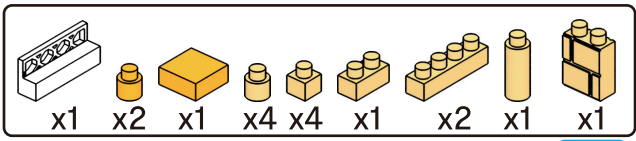

59



64







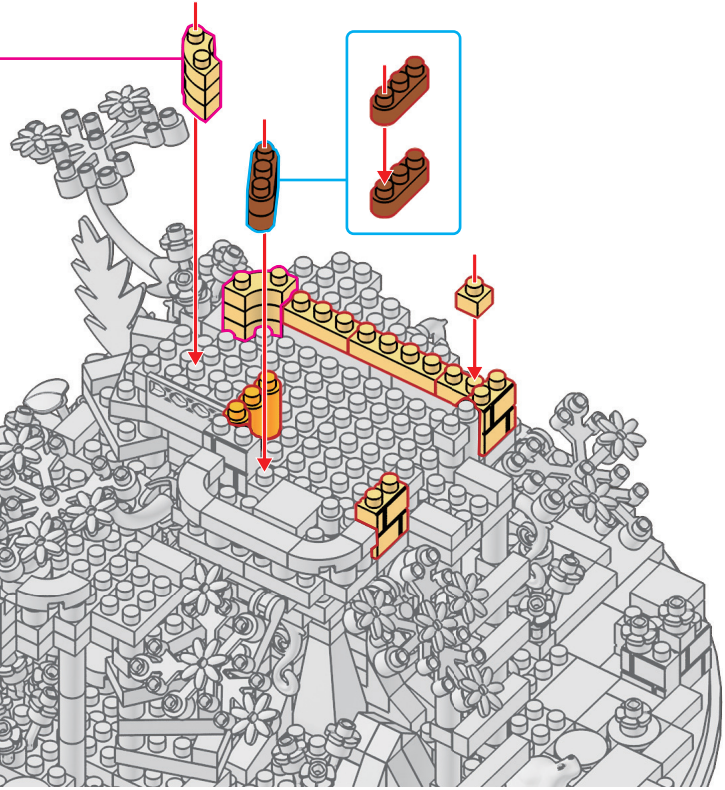
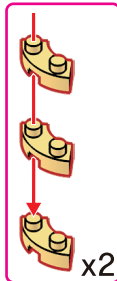

65

-  x3
-  x2
-  x1
-  x1
-  x6
-  x1
-  x1
-  x2

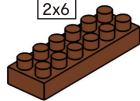
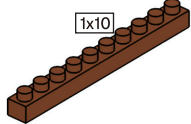

66

-  x1
-  x1
-  x2
-  x1
-  x1
-  x3
-  x1
-  x1 (labeled 2x6)
-  x1 (labeled 1x10)

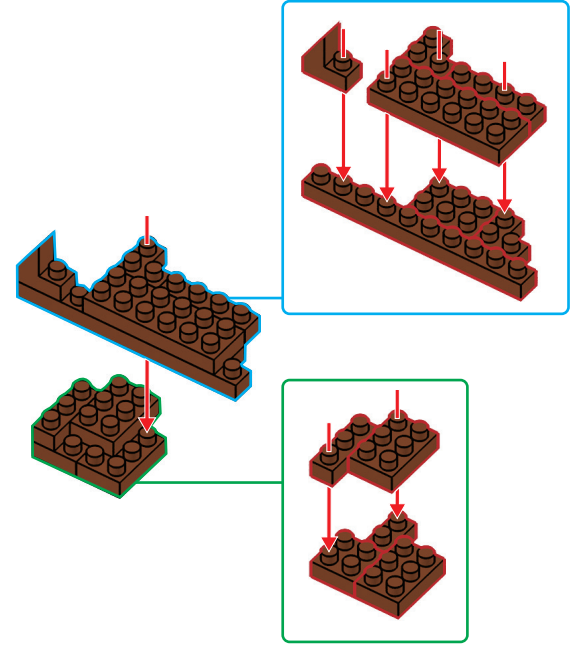

67

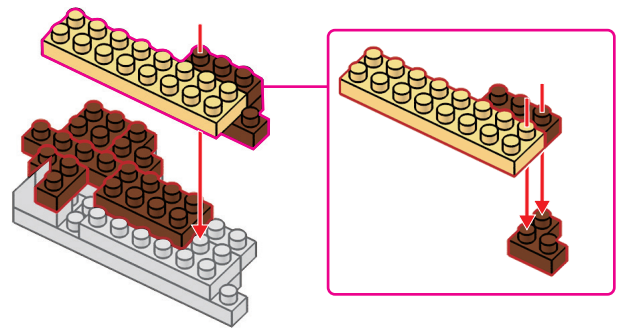
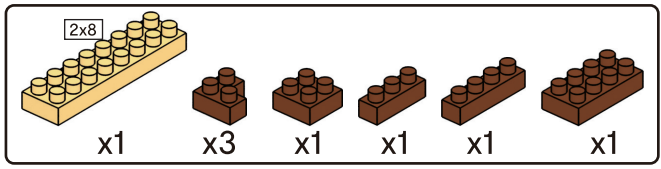

68

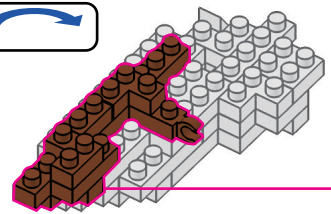
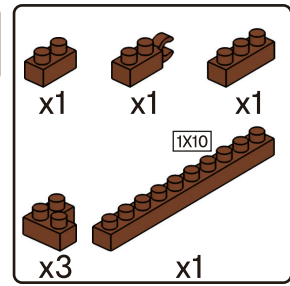

1

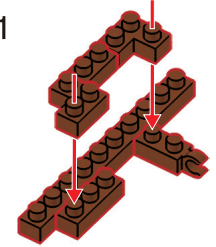

2

flip over

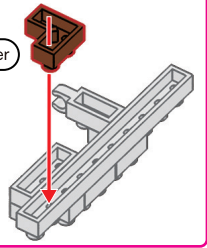

69

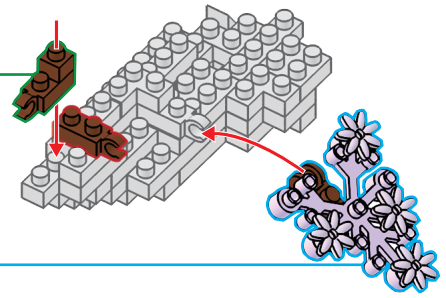
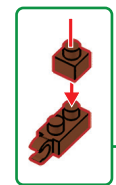
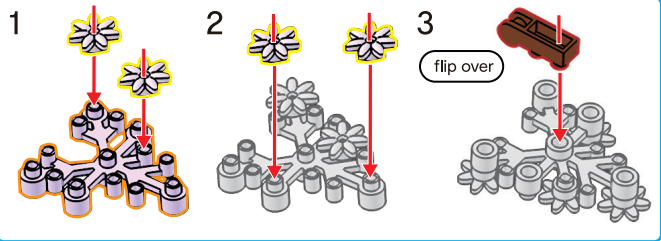
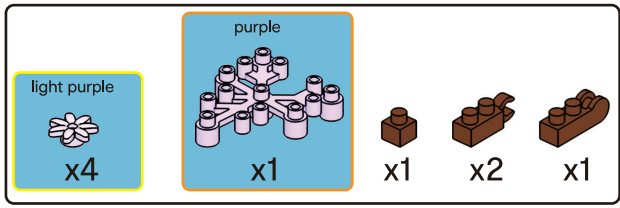

70

light purple  
x6

x2

purple  
x2

1

2

flip over

This panel shows the assembly of a flower-like structure. Step 1 shows three light purple flowers being attached to a purple base. Step 2 shows the assembly being flipped over and a brown brick being attached to the top.

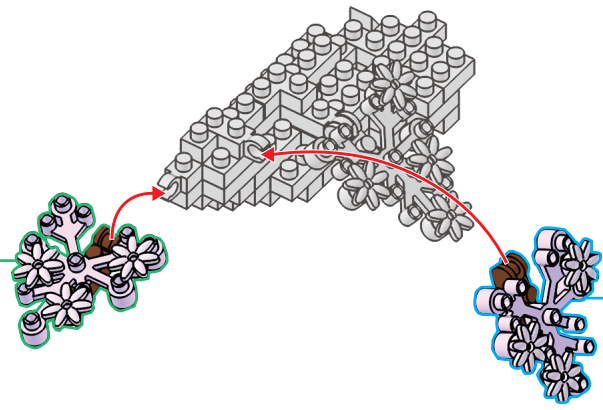

1

2

flip over

This panel shows the assembly of a flower-like structure. Step 1 shows three light purple flowers being attached to a purple base. Step 2 shows the assembly being flipped over and a brown brick being attached to the top.

71

light purple

x4

purple

x1

x2

x1

x1

x1

x1



70

65

1

2





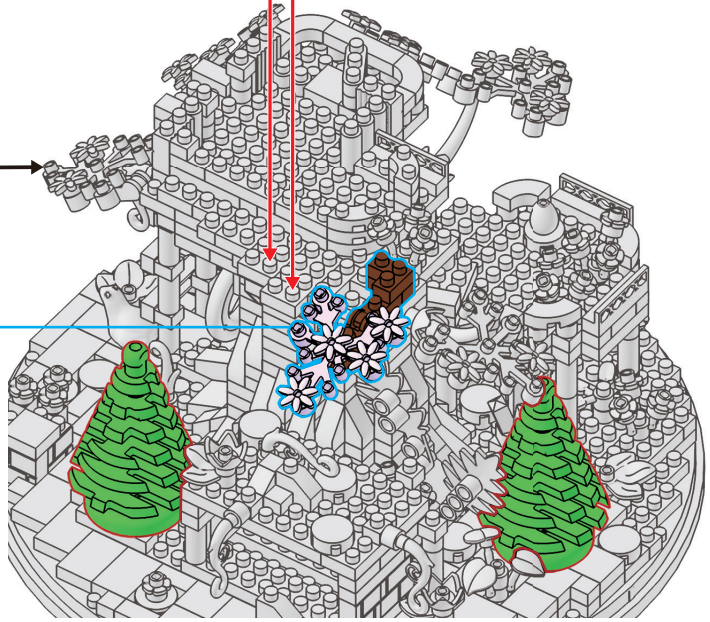
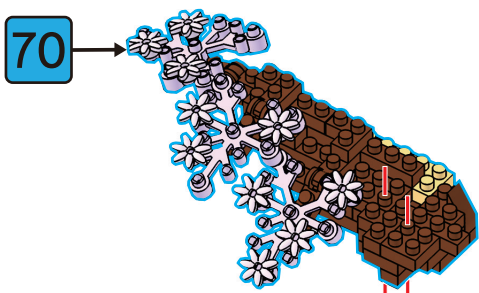

1

2

flip over



72

-  x2
-  x1
-  x6
-  x2
-  x1
-  x2

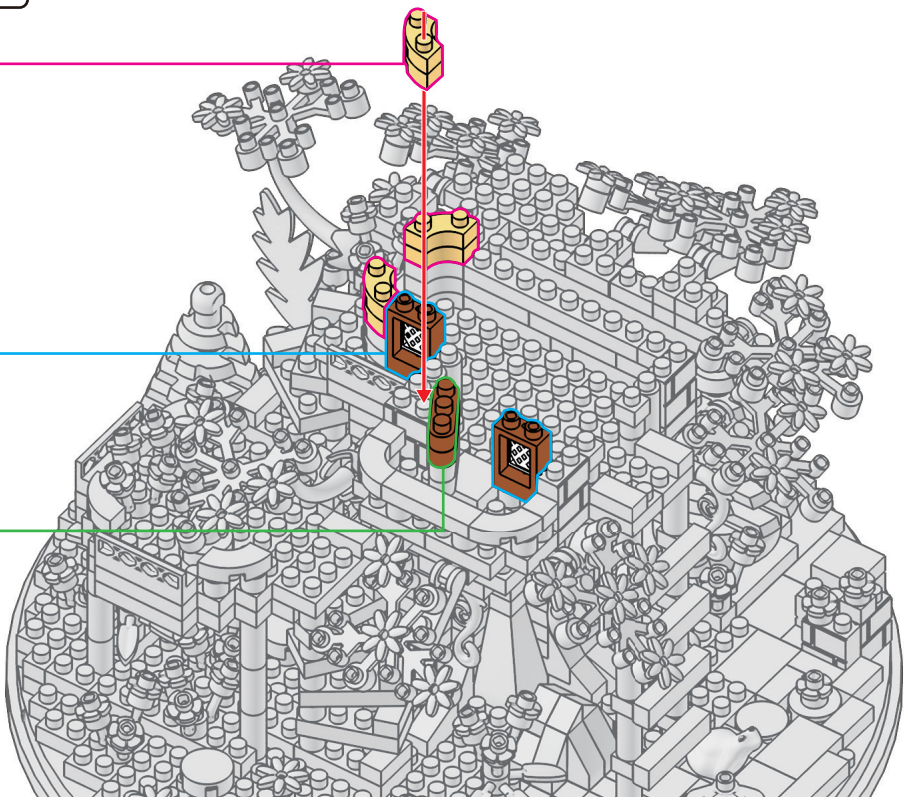
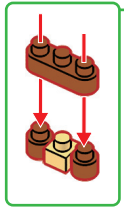
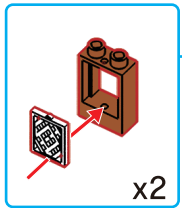
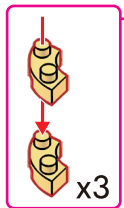

73

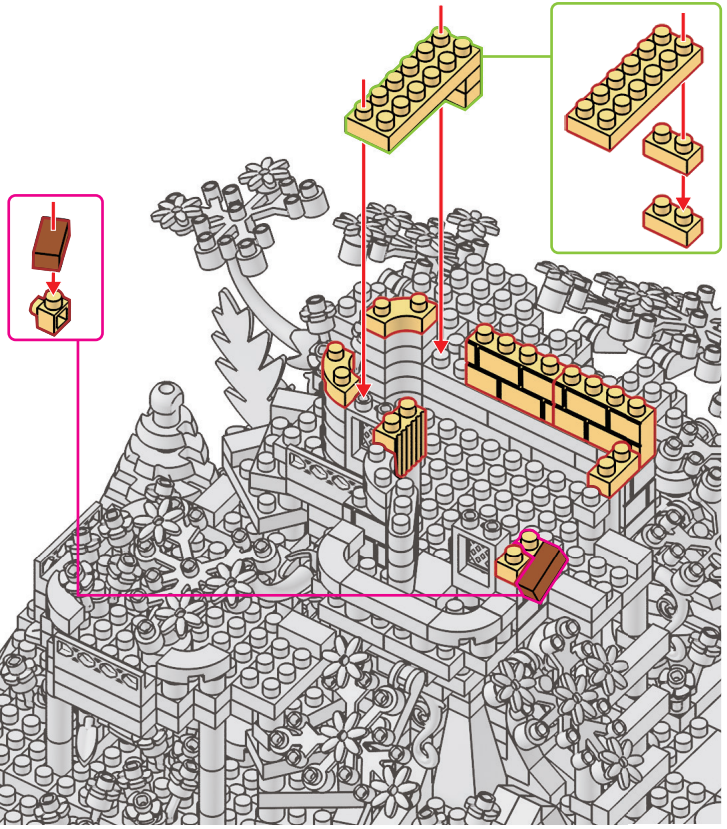
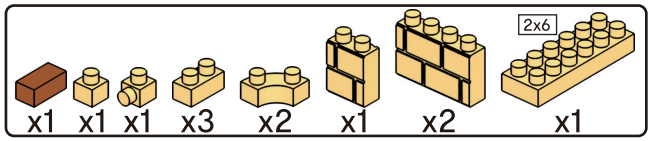

74

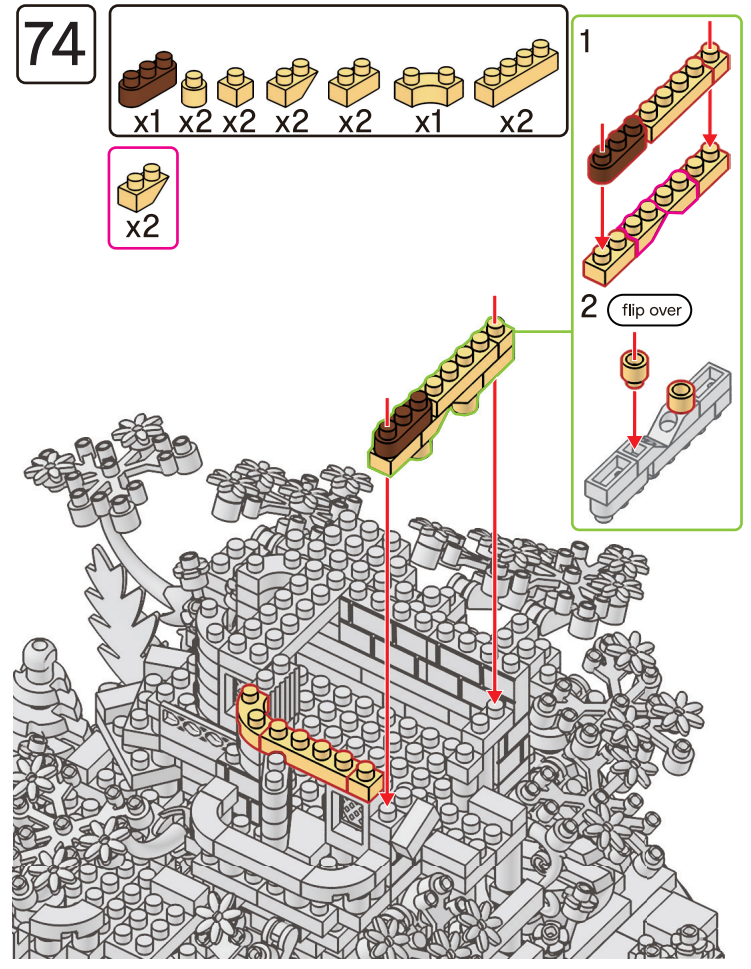
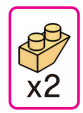
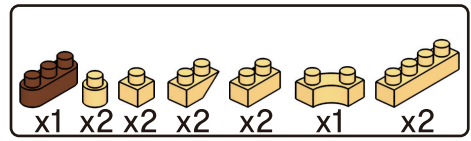



75

- x2
- x2
- x1
- x2
- x1
- x2
- x1
- x1
- x6
- x1
- x1

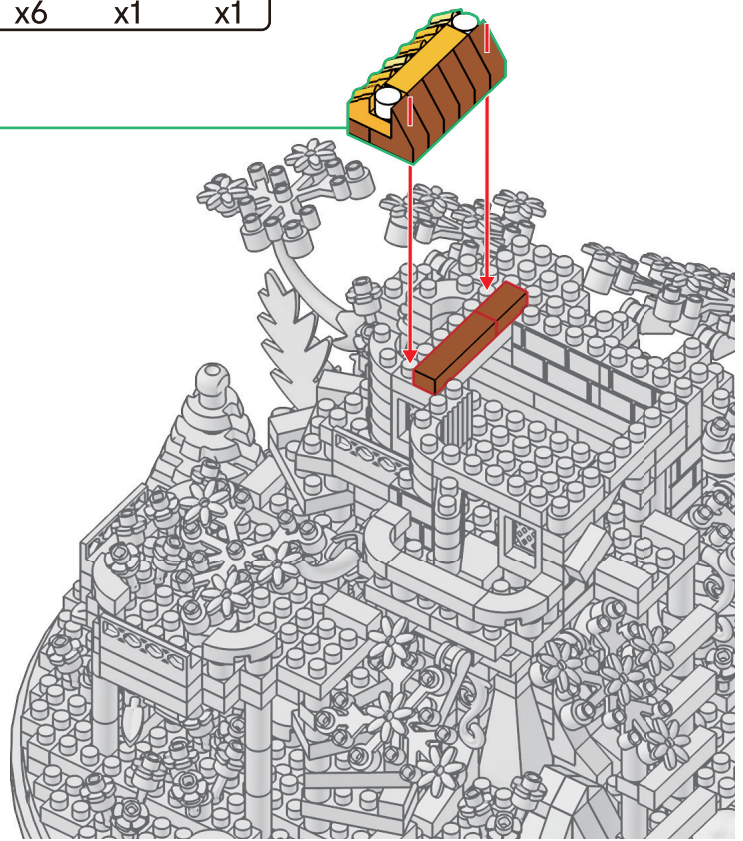
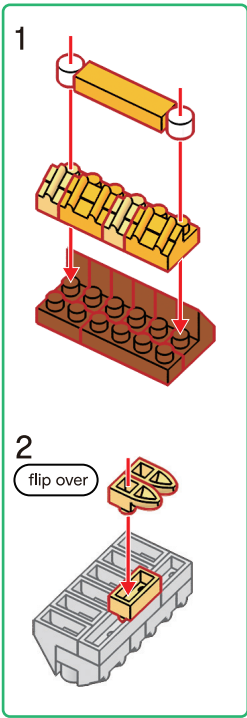

76

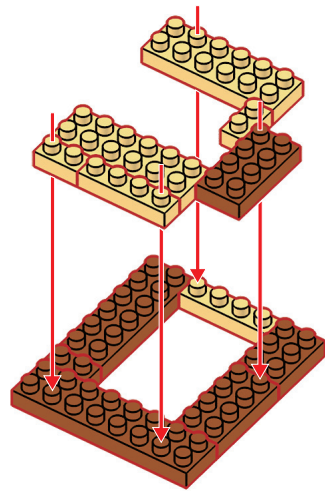
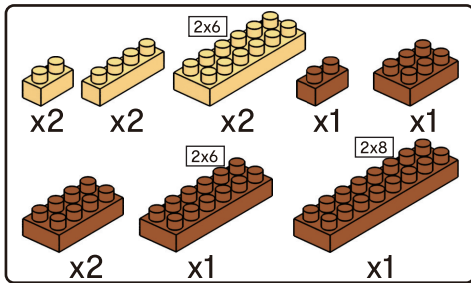

77

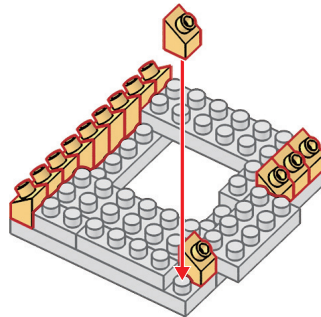
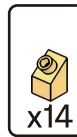

78

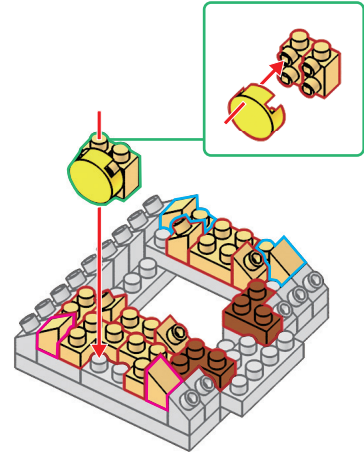
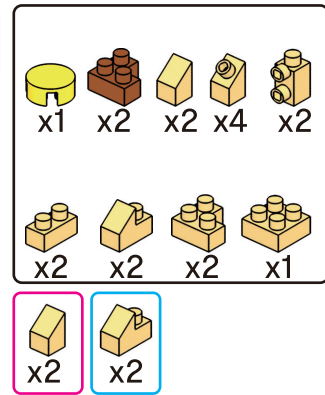

79

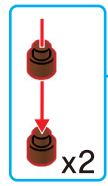
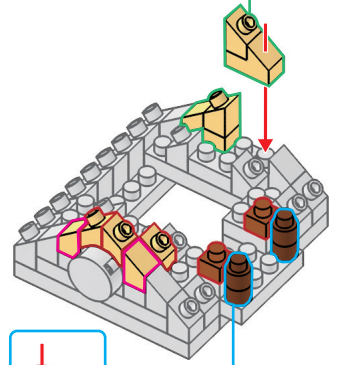
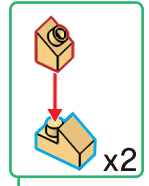
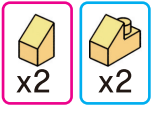
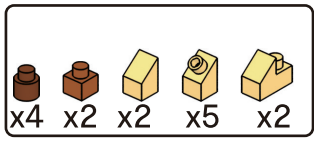

80

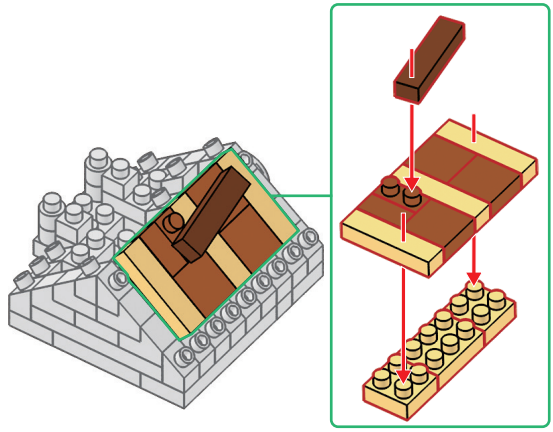
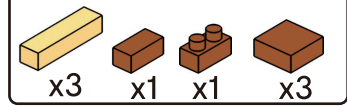
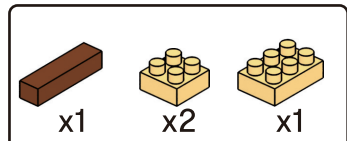

81

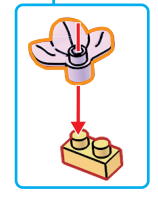
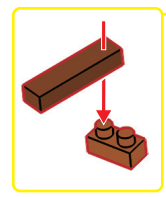
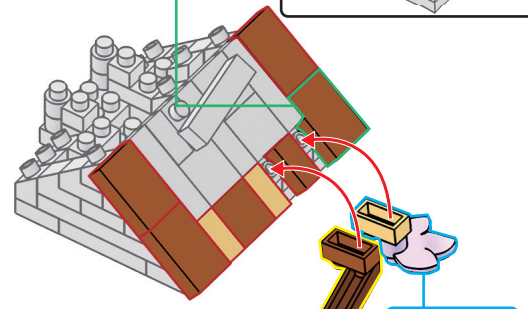
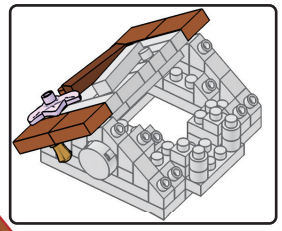
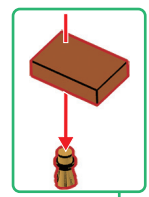
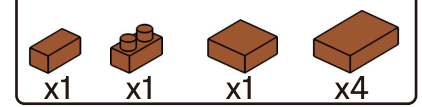
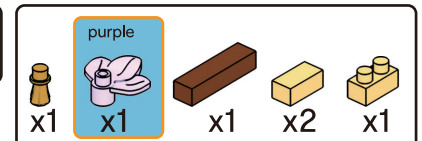

82

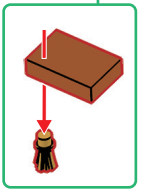
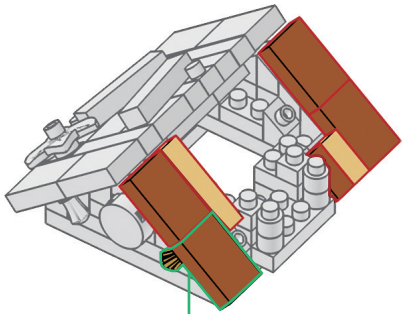
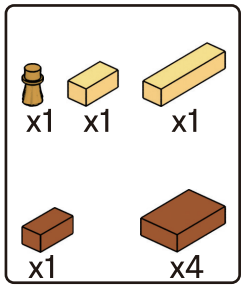

83

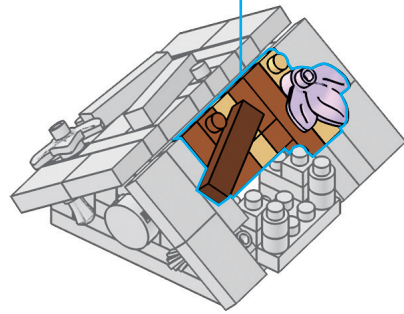
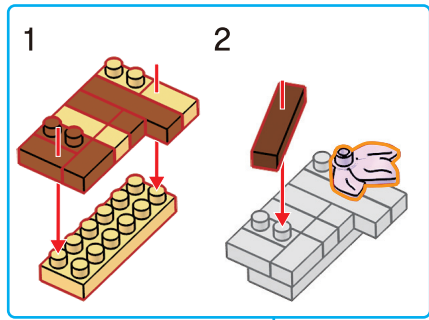
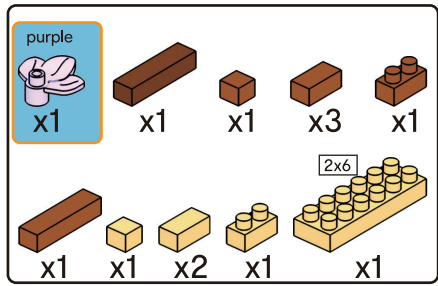

84

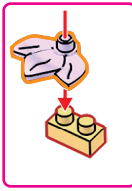
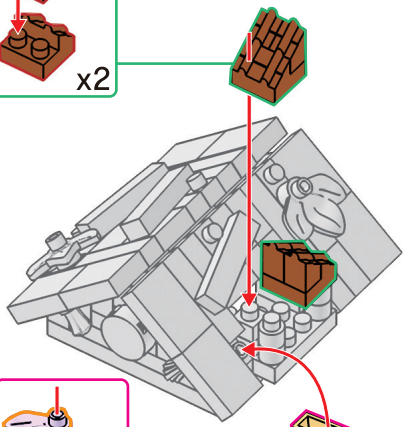
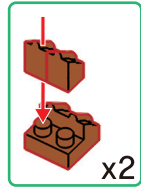
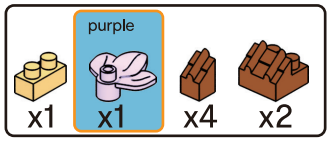

85

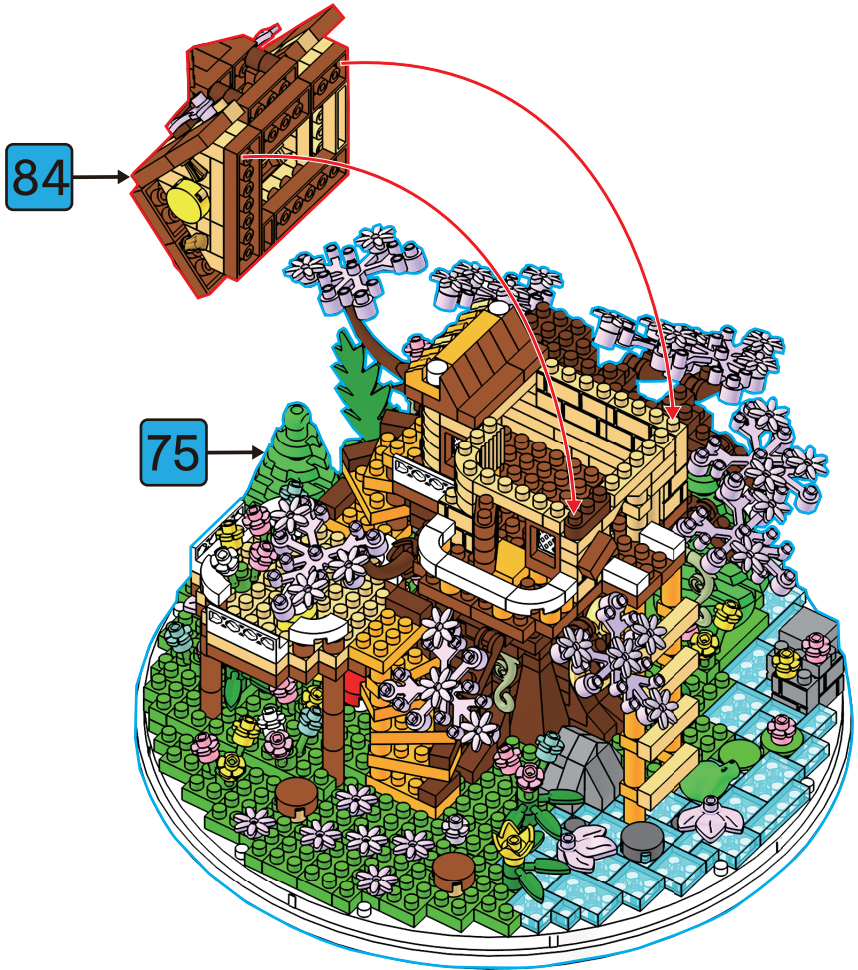

86

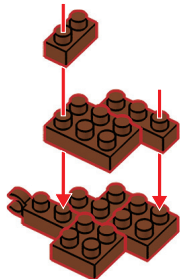
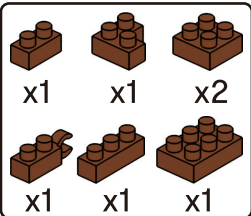

87

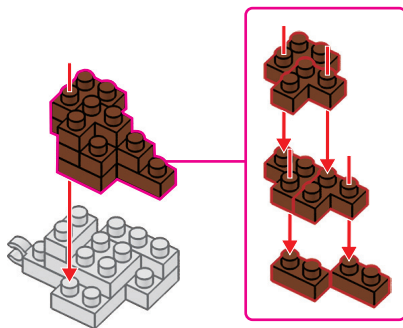
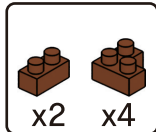

88

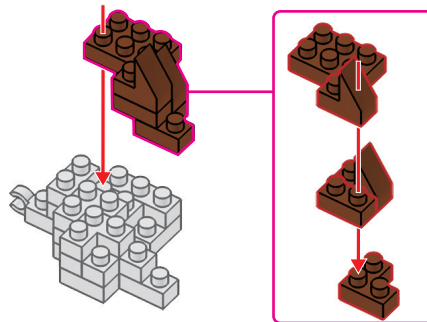
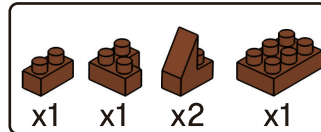

89

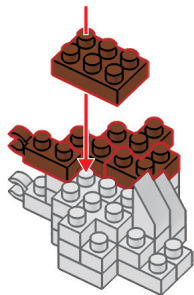
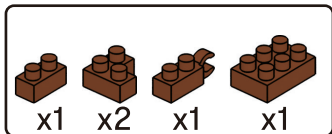

90

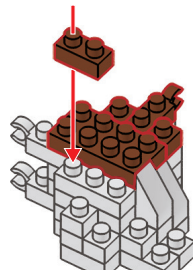
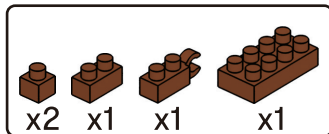

91

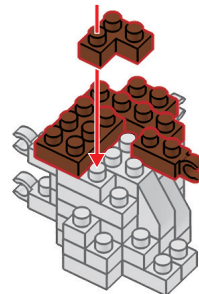
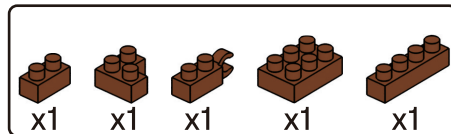

**92**

x2 x1 x1 x1

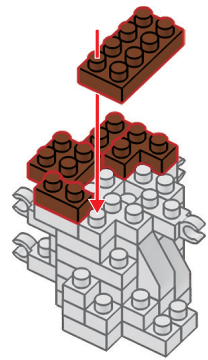

**93**

x1 x2 x1

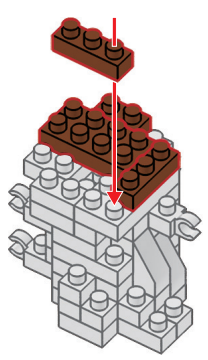

**94**

x4 x1 x2 x1

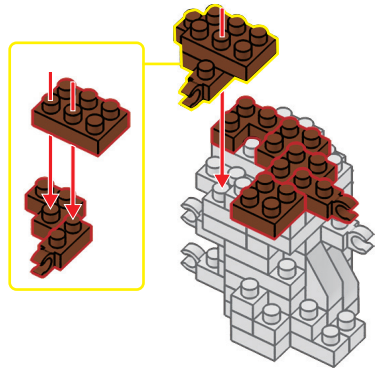

**95**

x2 x2 x1 x1

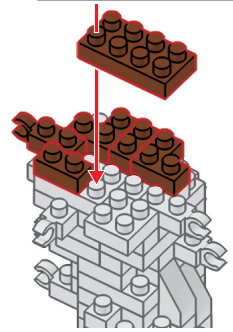

**96**

x2 x2 x1  
x1 x1 x1

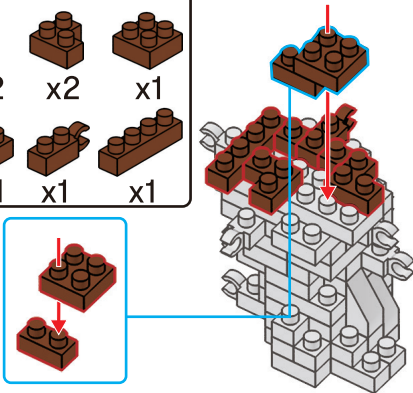

**97**

x2 x1 x1  
x2 x1

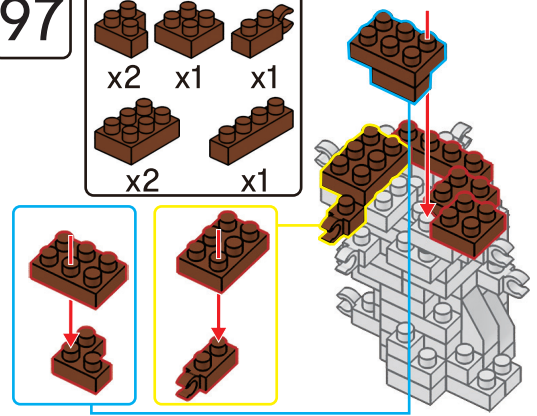

98

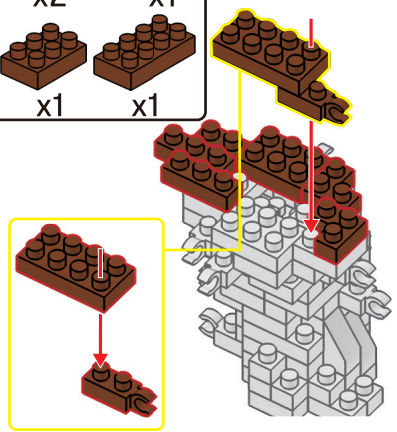
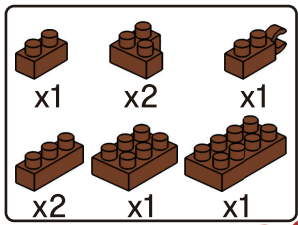

99

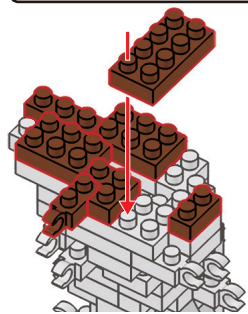
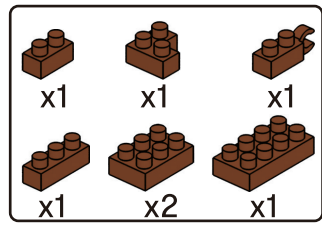

100

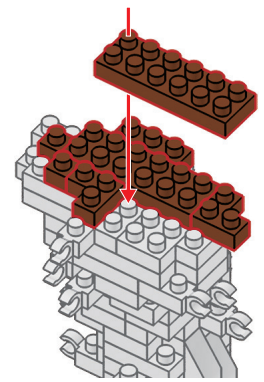
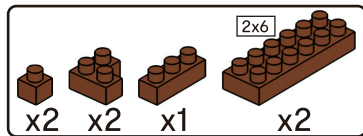

101

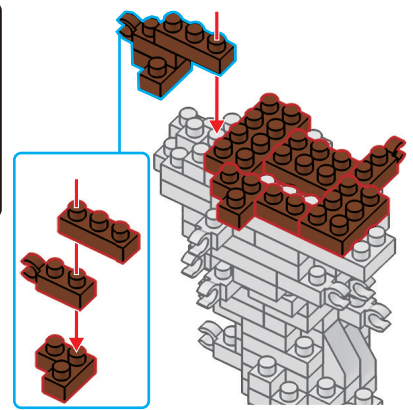
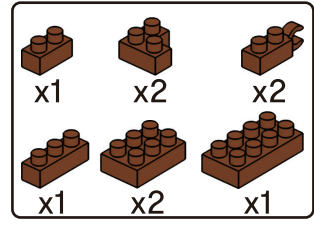

102

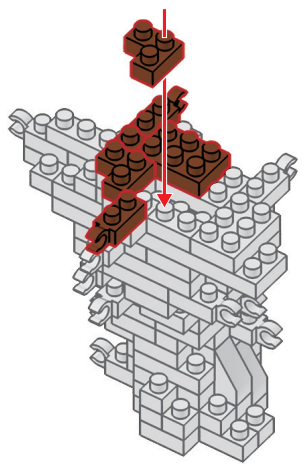
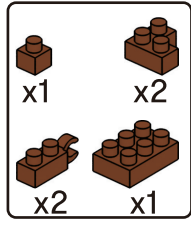



103

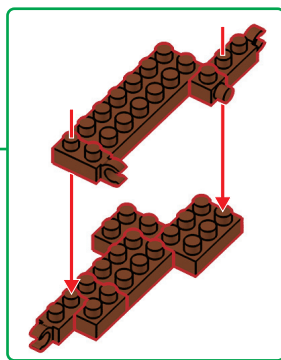
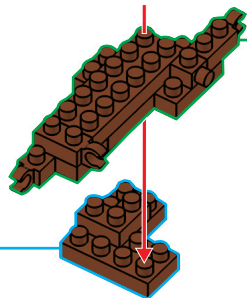
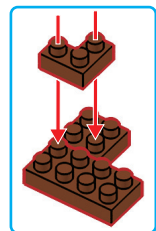
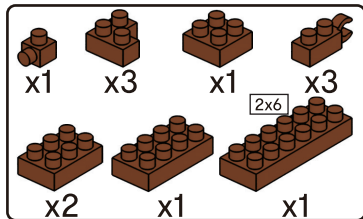

104

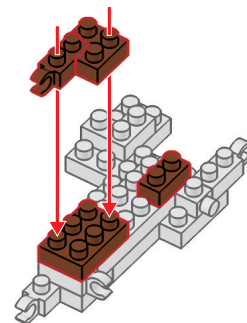
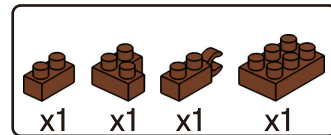

105

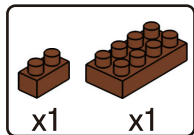

flip over

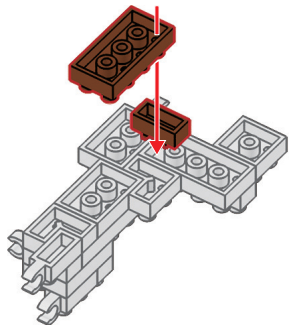

106

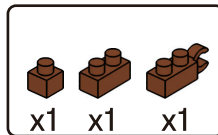

flip over

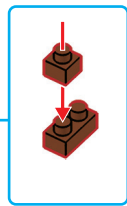
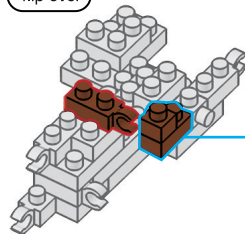

107

106

102

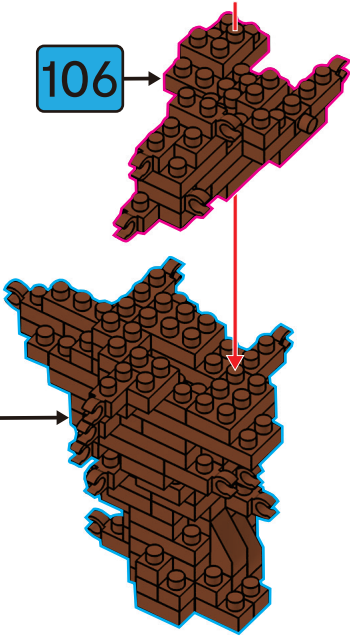

108

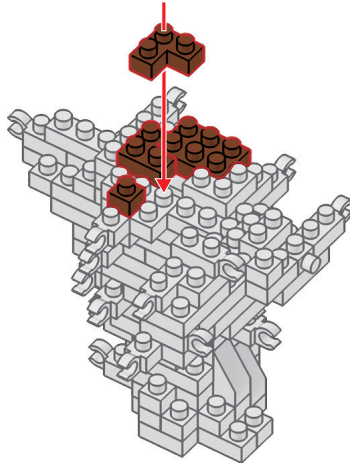
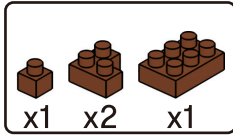

109

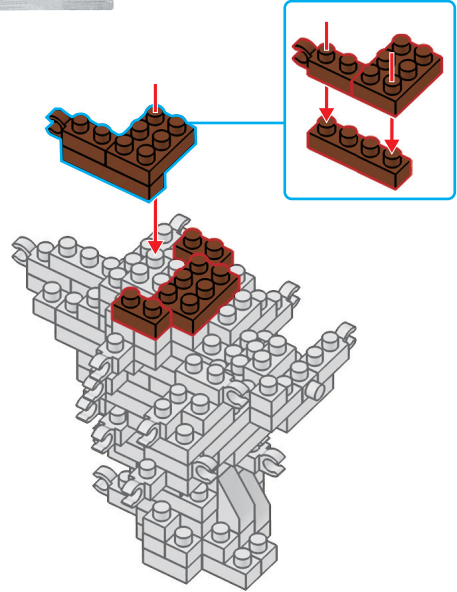
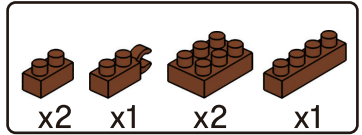

110

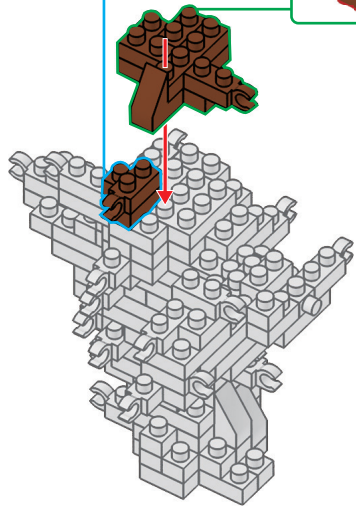
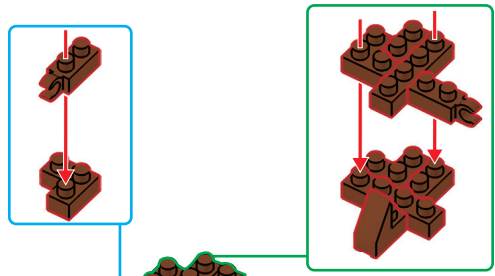
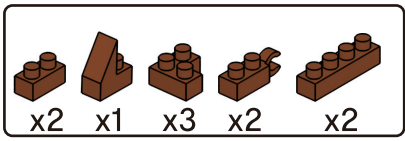

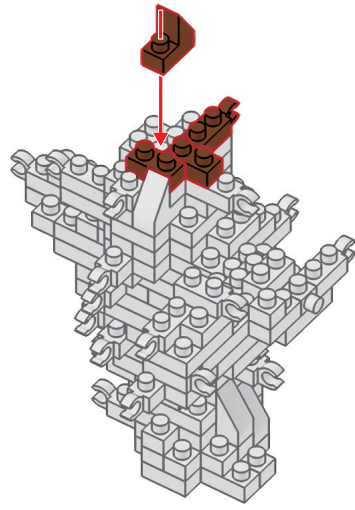
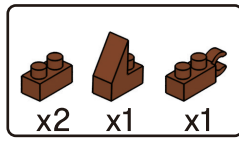

111

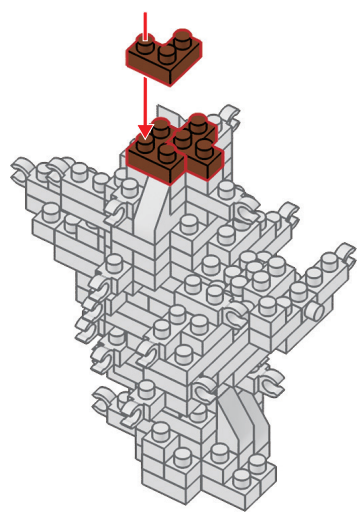
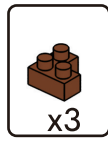

112

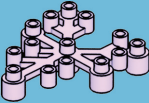
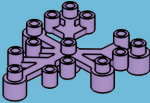

113

light purple  x5	 x1	purple  x1	dark purple  x1
---	---	---	--

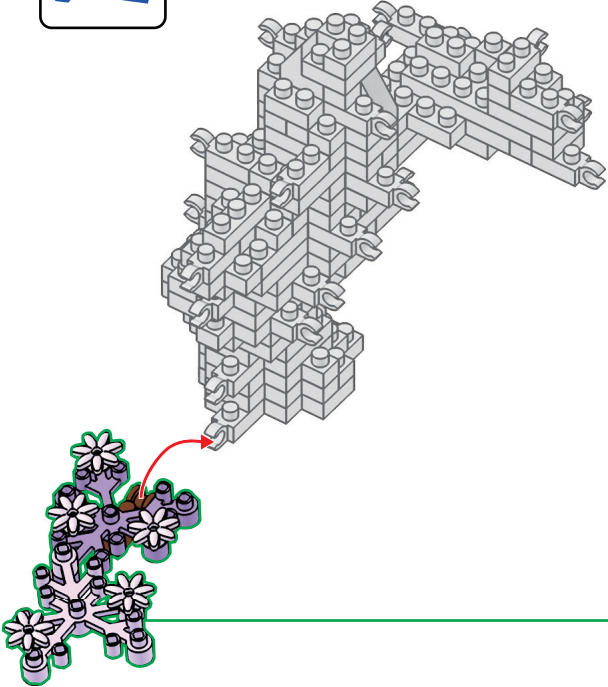

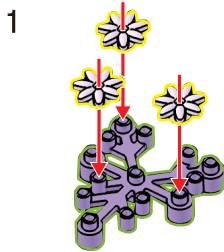
1 

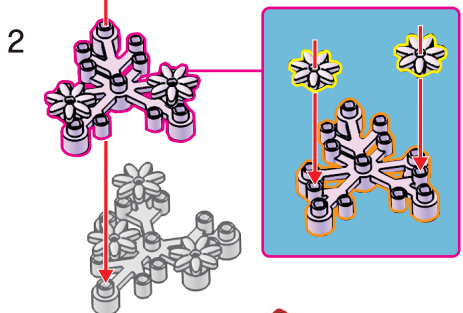
2 

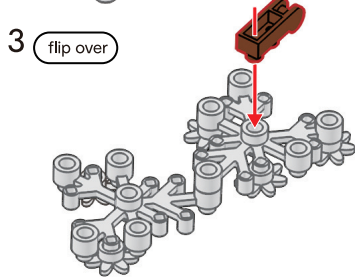
3 flip over 



light purple  
x7

x1

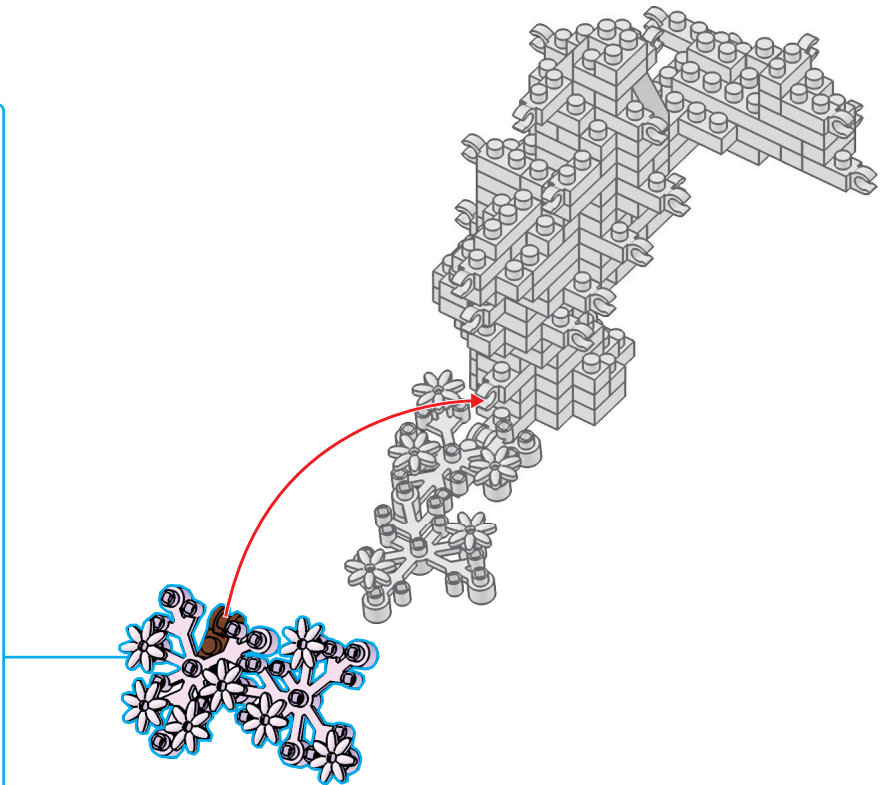
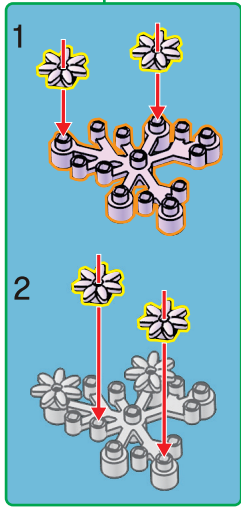
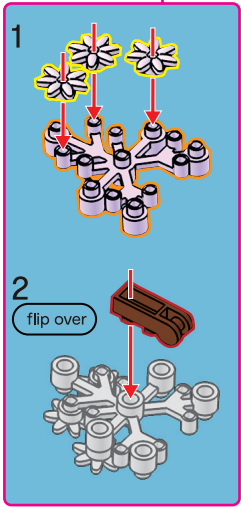
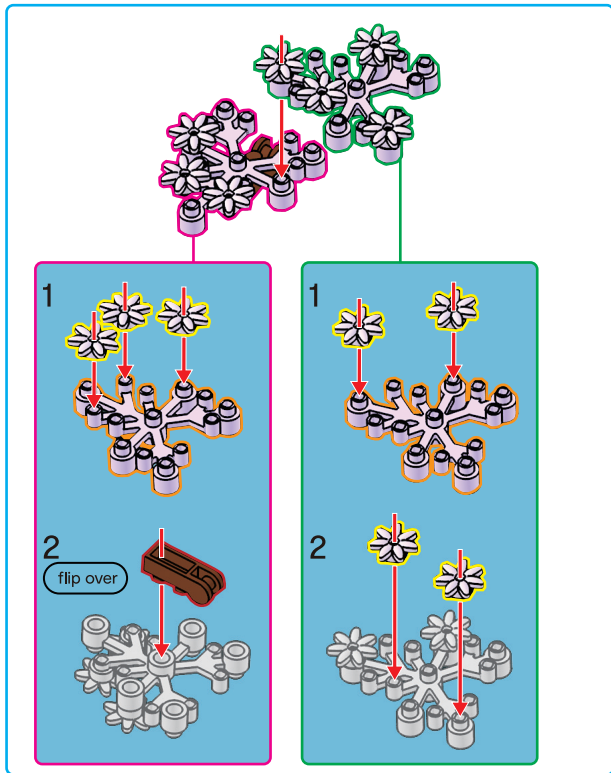
purple  
x2

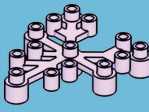
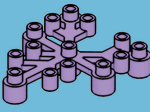

115

light purple  x5	 x1	purple  x1	dark purple  x1
---	---	---	--

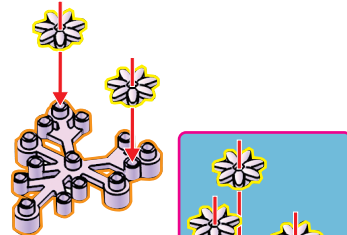
1 

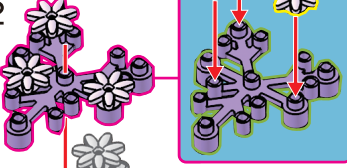
2 

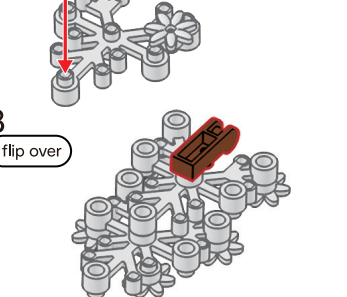
3   
flip over

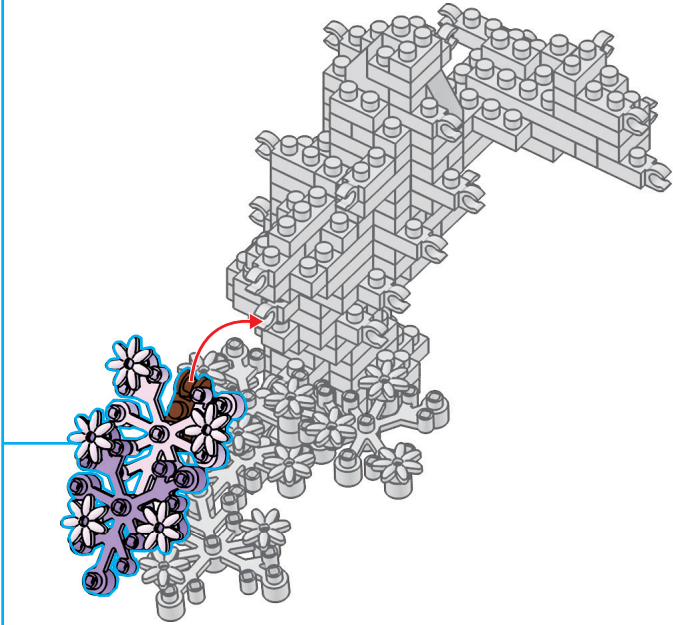

116

light purple  
x3

x1

purple  
x1

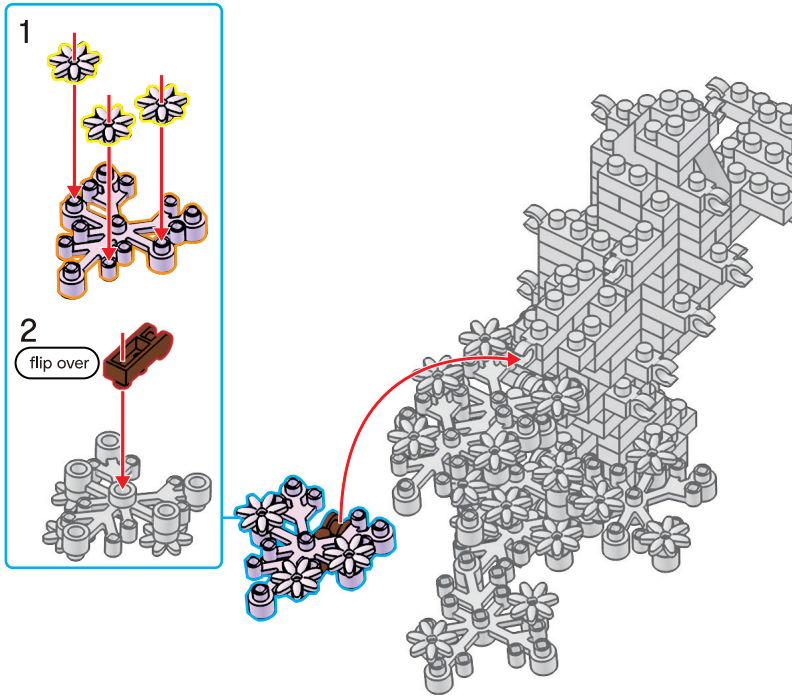

117

light purple  
x3

x1

dark purple  
x1

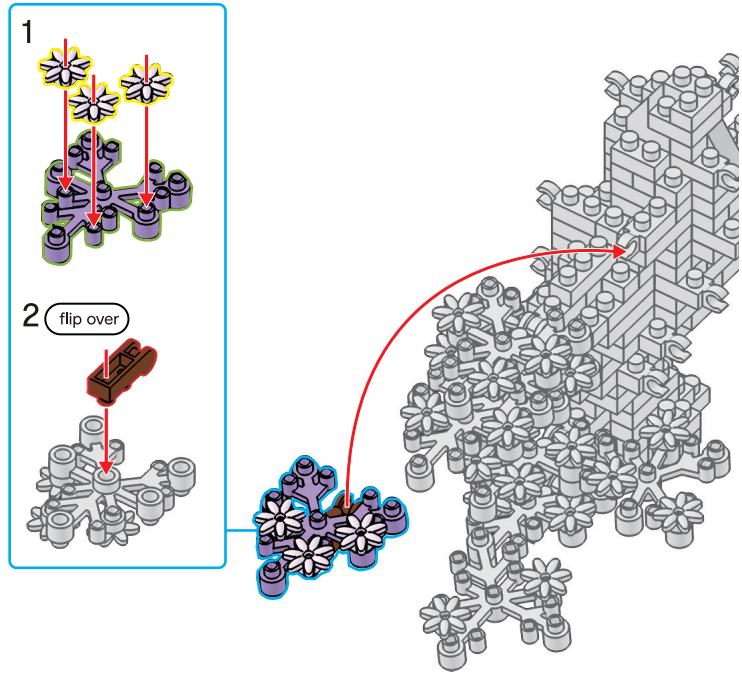

118

light purple  
x3

purple  
x1

x1

x1

1

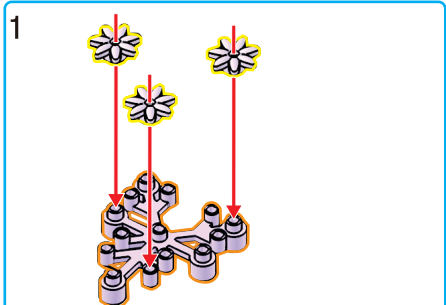

2

flip over

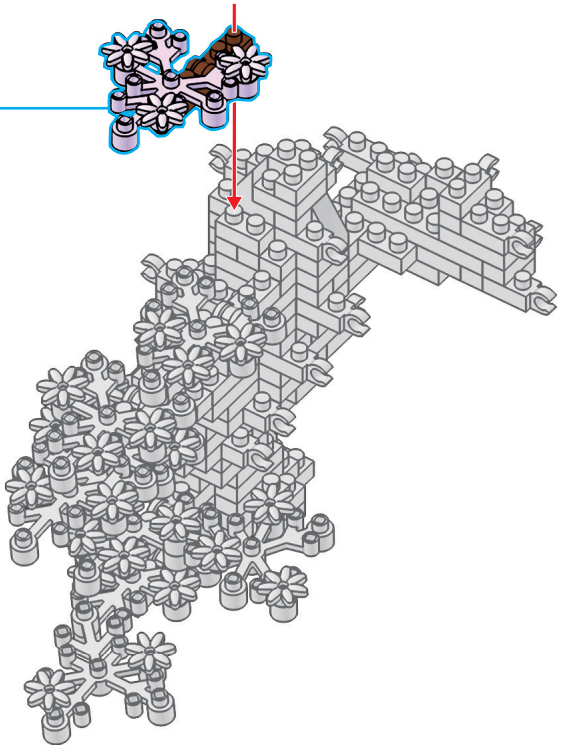
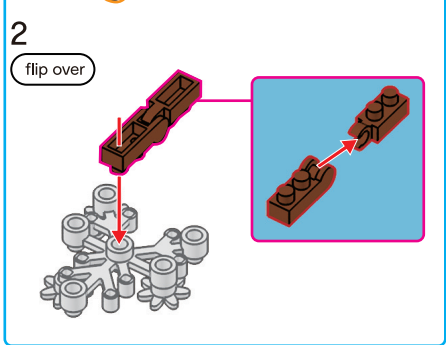



119

light purple  
x2

x1

purple  
x1



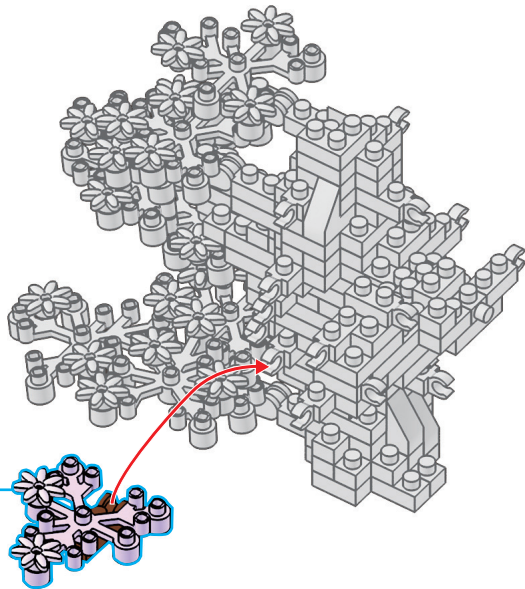

1

2 flip over

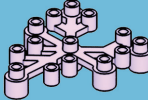
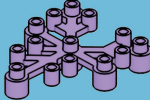

120

light purple  x11	 x1	purple  x2	dark purple  x2
--	---	---	--

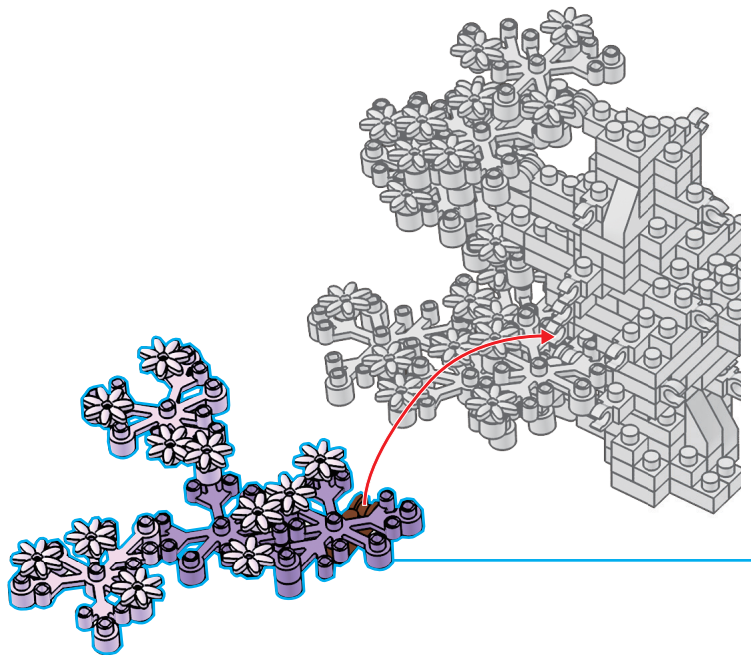

1

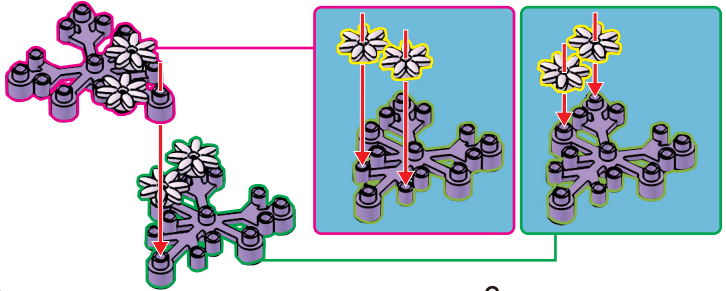

2

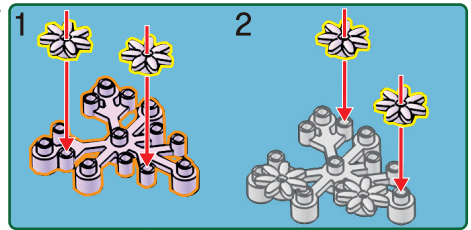

3

flip over

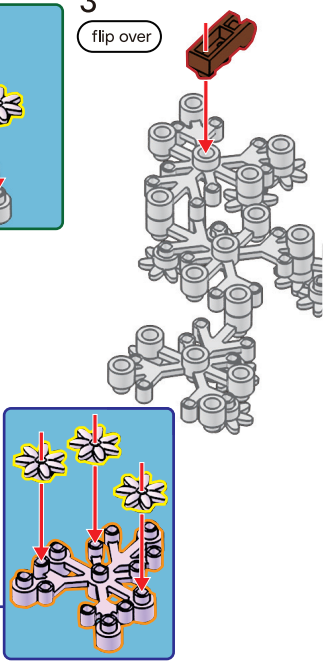

121

light purple



x10



x1

purple

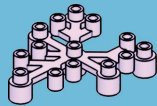

x2

dark purple

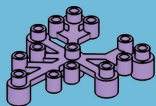

x1

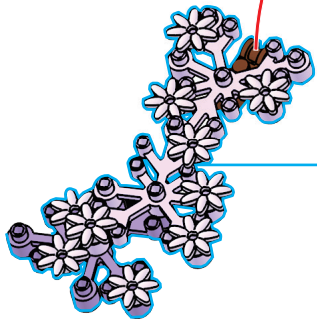
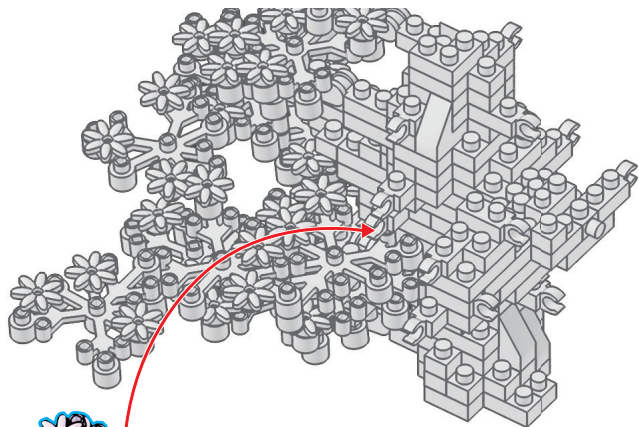

1

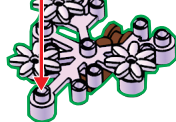
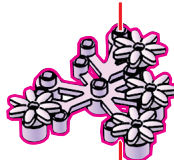

1

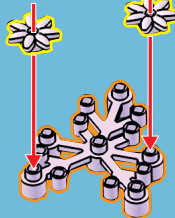

2

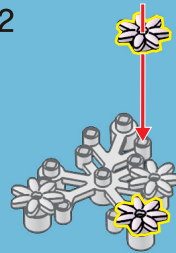

1

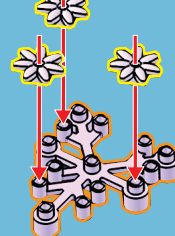

2

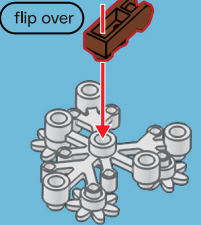

flip over

2

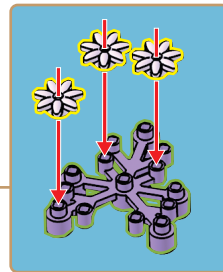
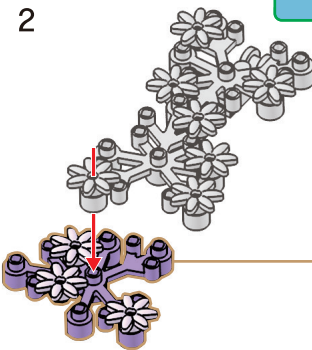

122

light purple  
x9



x1

purple  
x2

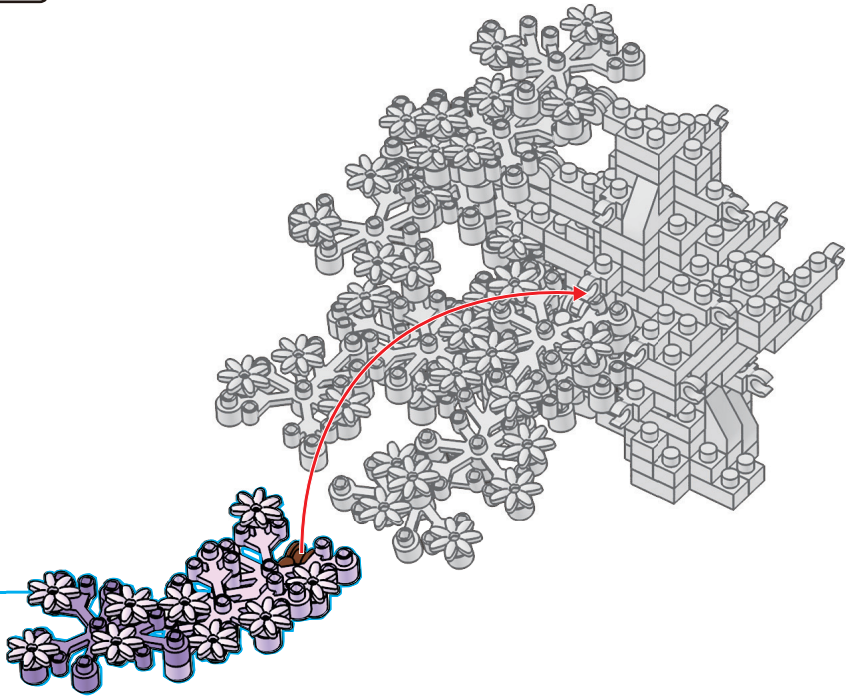
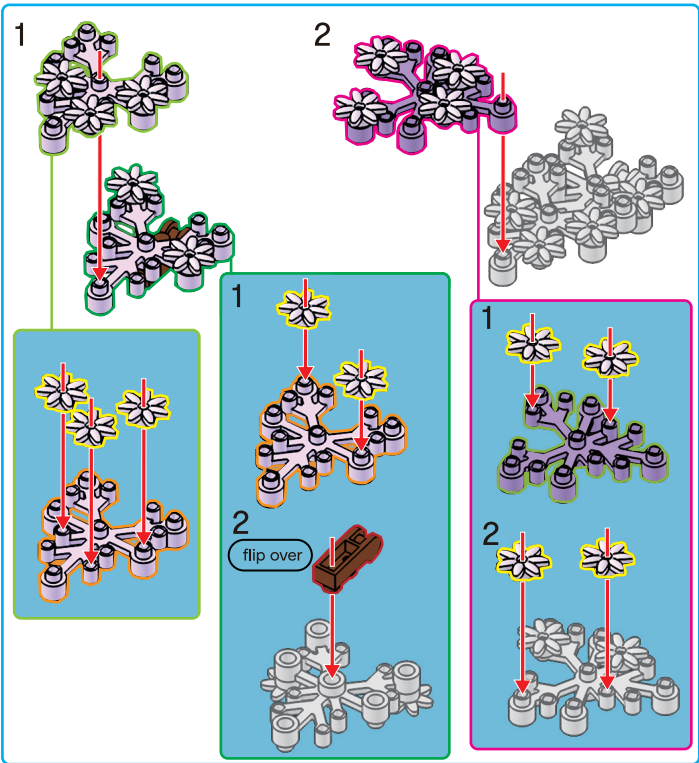
dark purple  
x1

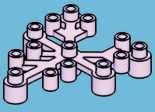
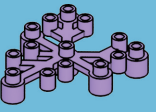

123

<p>light purple</p>  <p>x7</p>	 <p>x1</p>	<p>purple</p>  <p>x1</p>	<p>dark purple</p>  <p>x1</p>
---	---	---	--

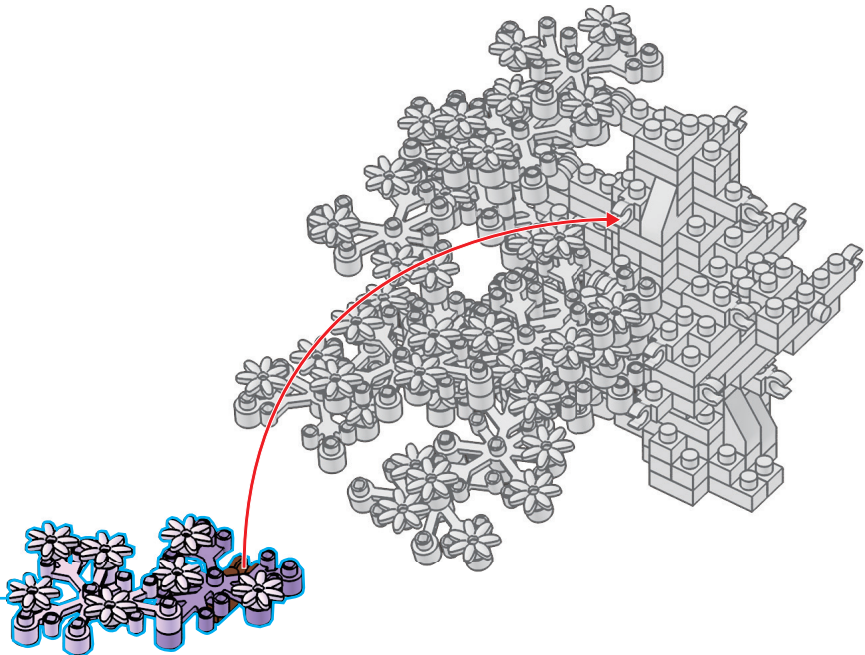
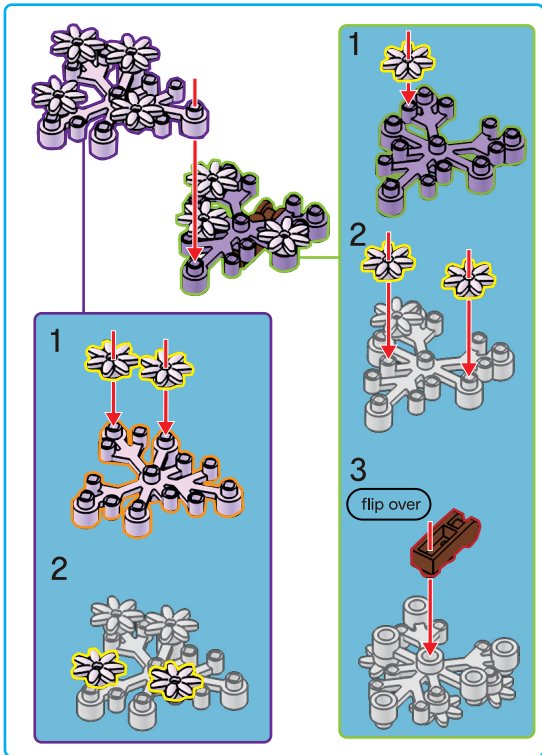

124

light purple



x7



x2

purple

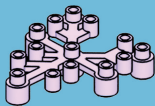

x1

dark purple

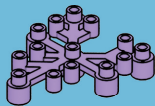

x1

10

1

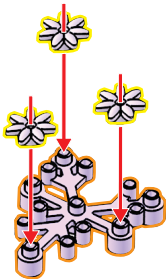

2

flip over

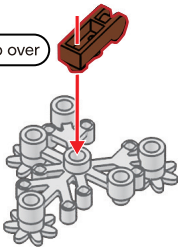

1

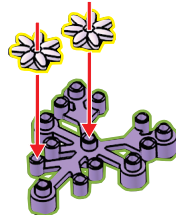

2

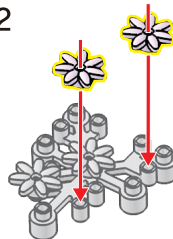

3

flip over

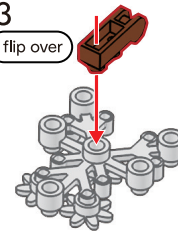

125

light purple x9

x2

purple x1

dark purple x2



1

2

flip over

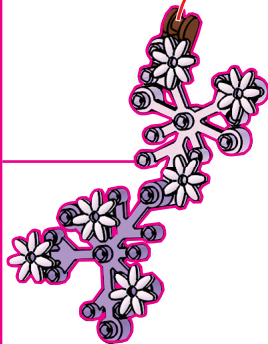
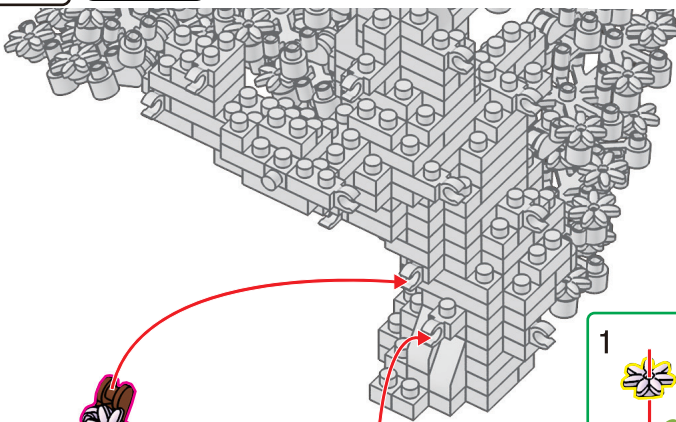

1

2

flip over

light purple x8

x1

purple x2

dark purple x1

flip over

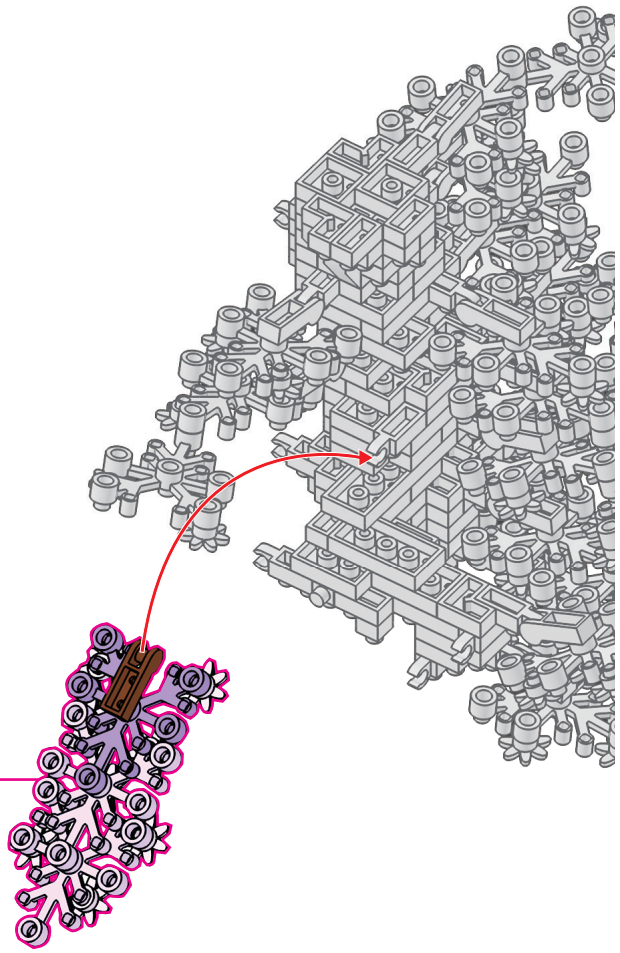
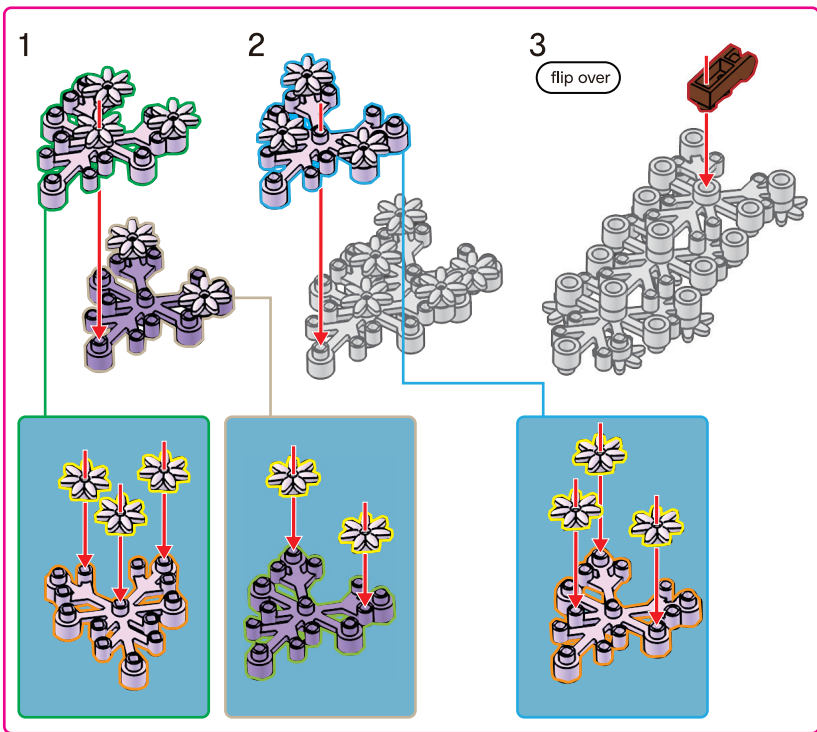



127

light purple x9	x2	purple x1	dark purple x2
--------------------	----	--------------	-------------------

flip over

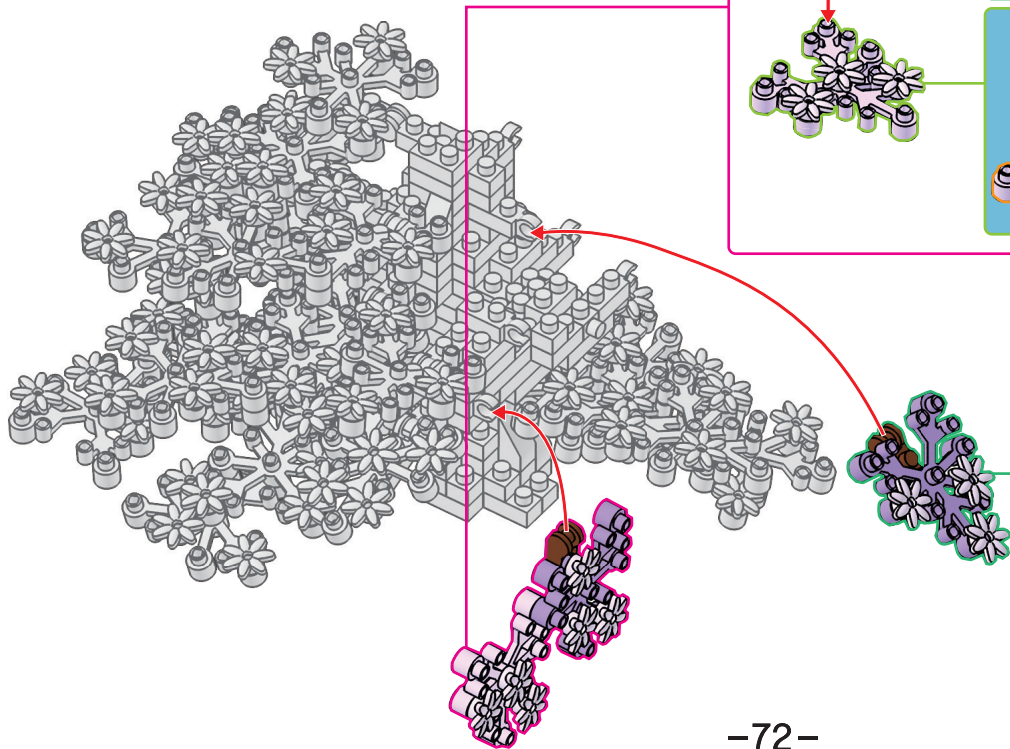

1

2 flip over

1

2 flip over

128

light purple x5

purple x1

dark purple x1

x2 x1 x1

1

2

3 flip over

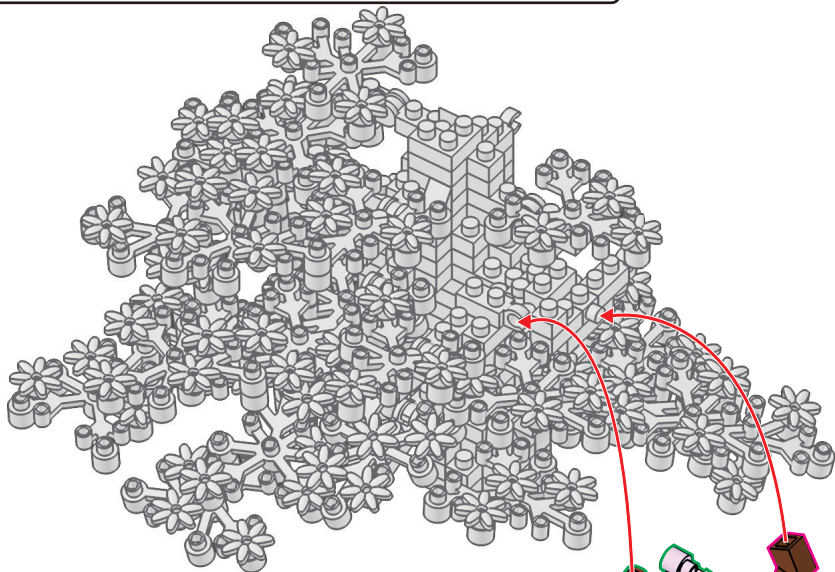

1

2 flip over

129

light purple  
x7

x2

purple  
x2

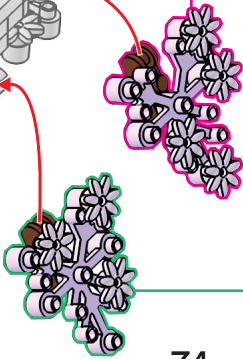
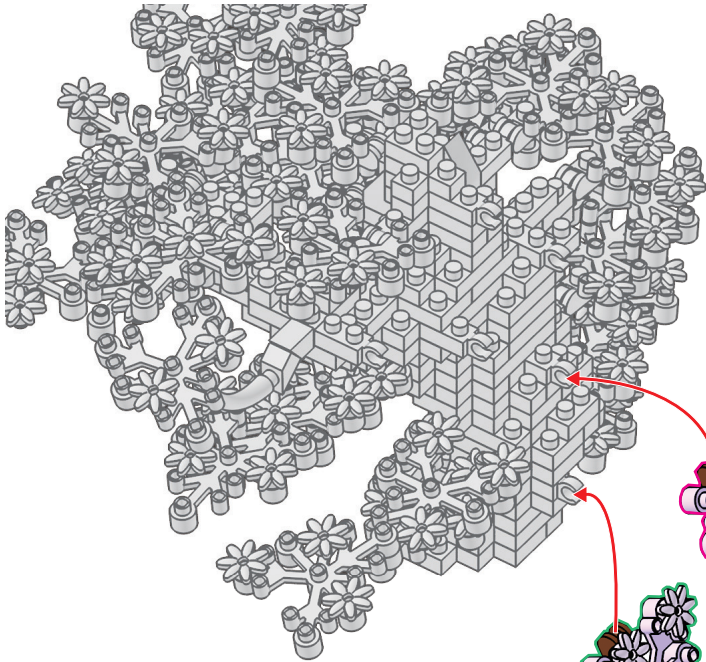

1



2

3 flip over

1

2 flip over

130

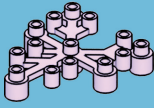
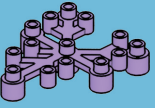
light purple  x7	 x2	purple  x1	dark purple  x1
---	---	---	--

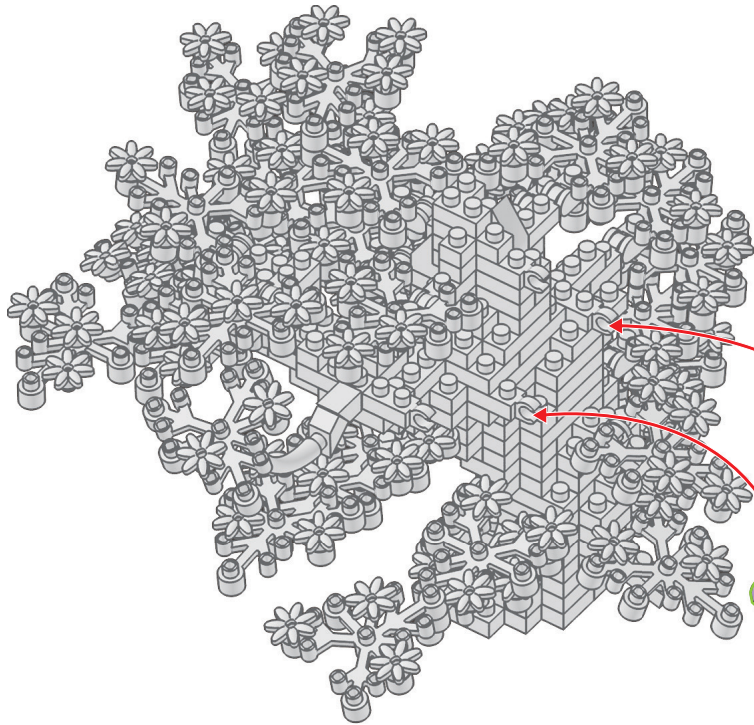

1

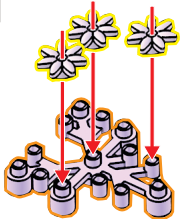

2

flip over

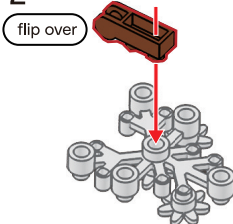

1

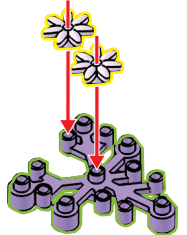

2

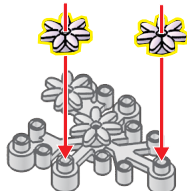



3

flip over

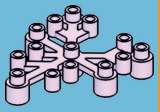
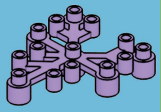

131

light purple  x6	 x2	purple  x1	dark purple  x1
---	---	---	--

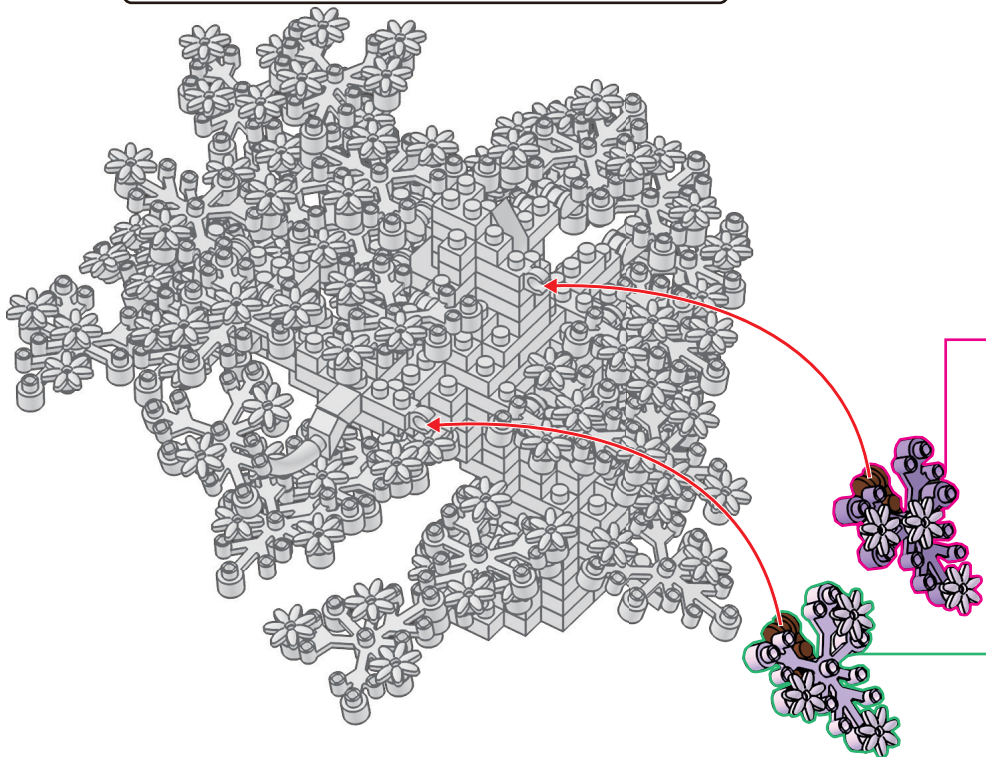

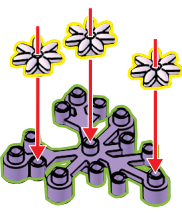
1 

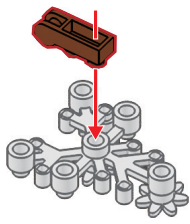
2 flip over 

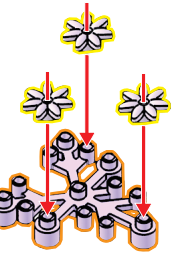
1 

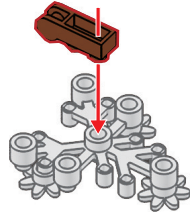
2 flip over 

132

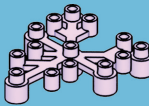
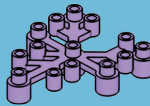
light purple  x6	purple  x1	dark purple  x1
---	---	--

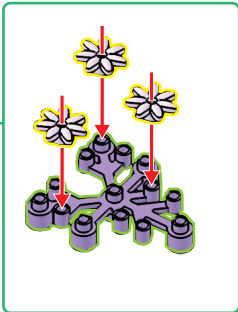
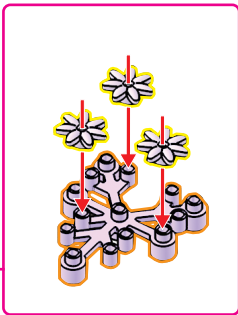
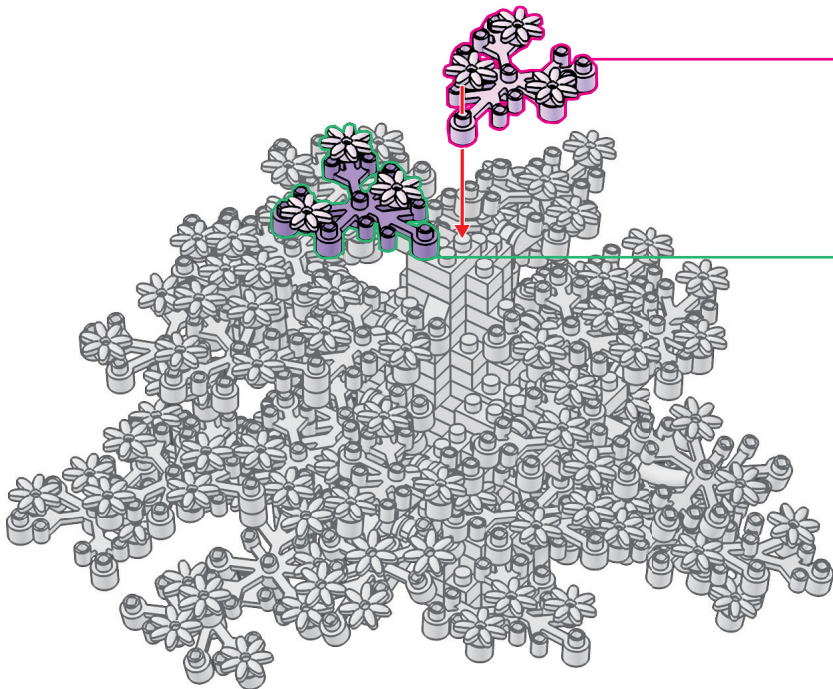

133

light purple  
x6



purple  
x2

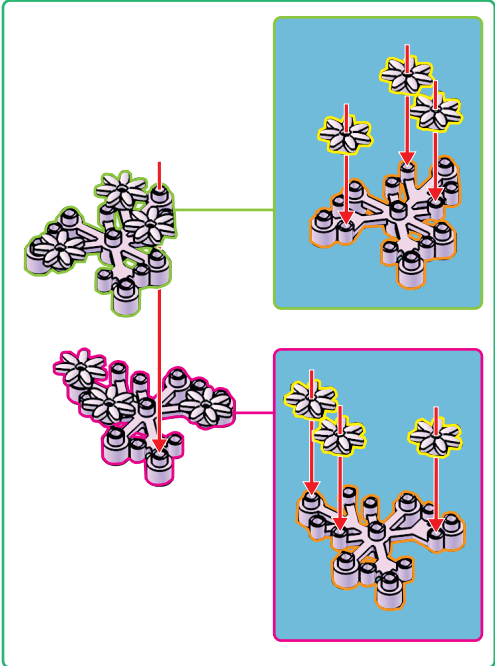
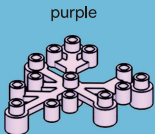
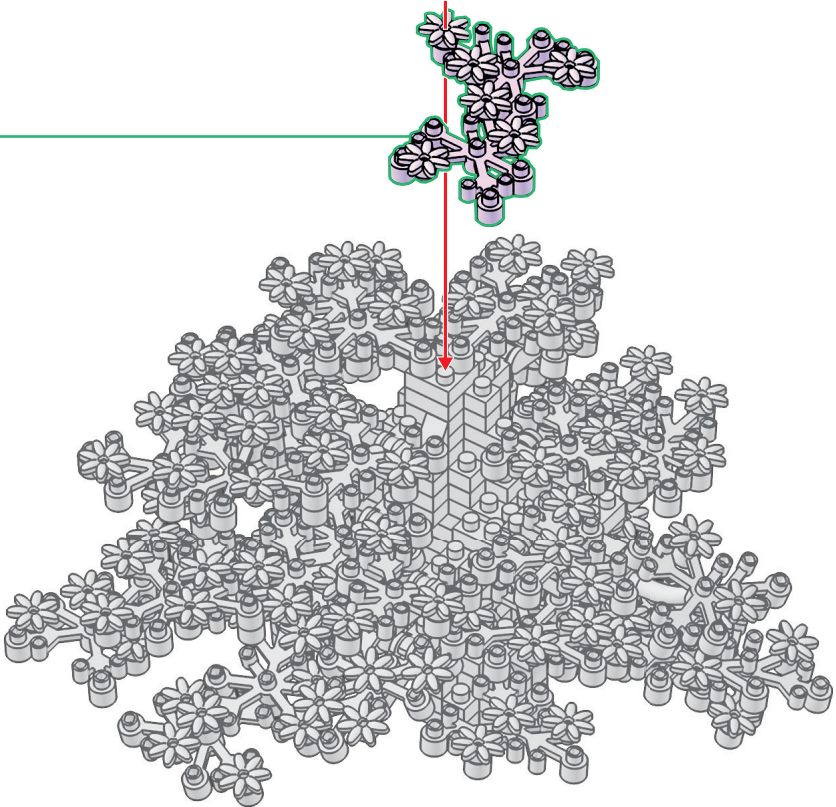

Diagram illustrating the assembly of two sub-structures. The top sub-structure is light purple and the bottom is purple. Red arrows indicate the placement of the pieces.



Main assembly diagram showing a large, complex structure made of many small pieces. A red arrow points to a specific location on the top surface where a new piece should be added.

134

flip over

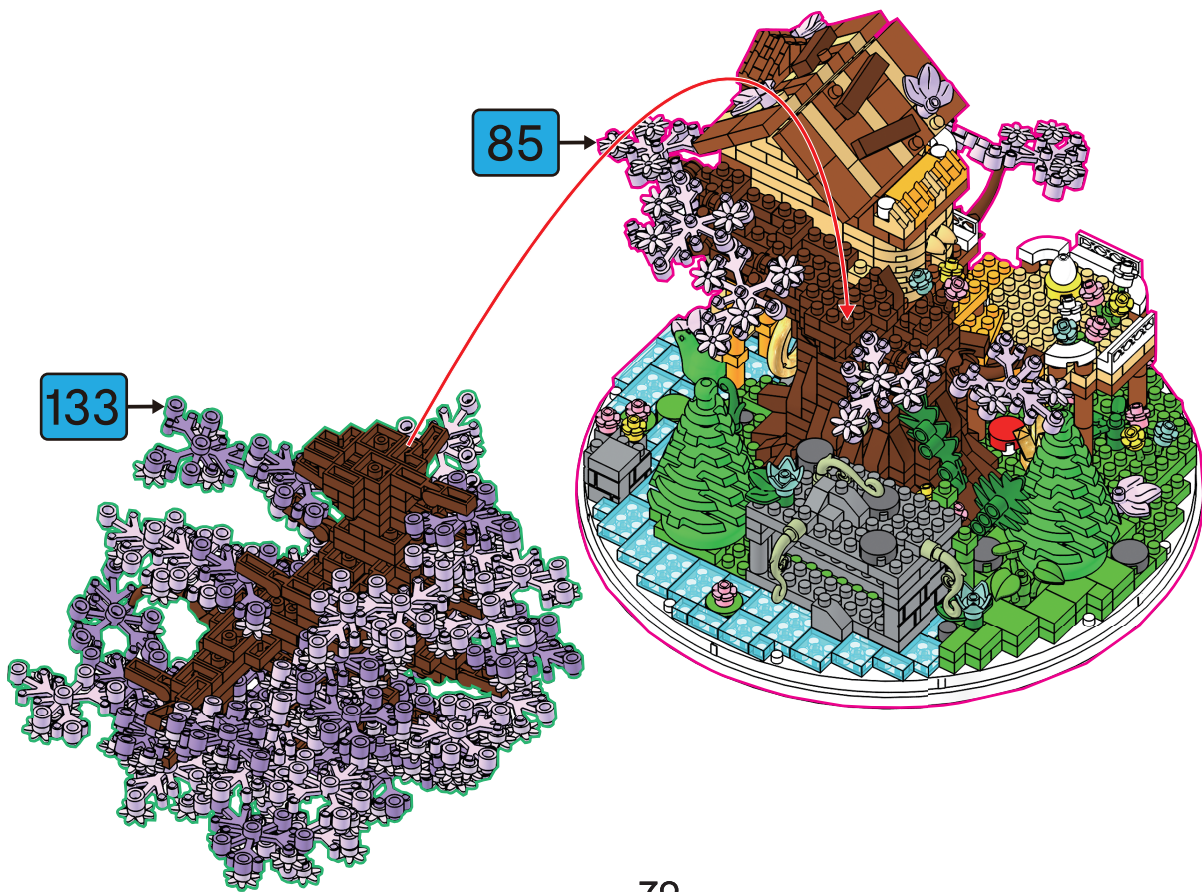



135

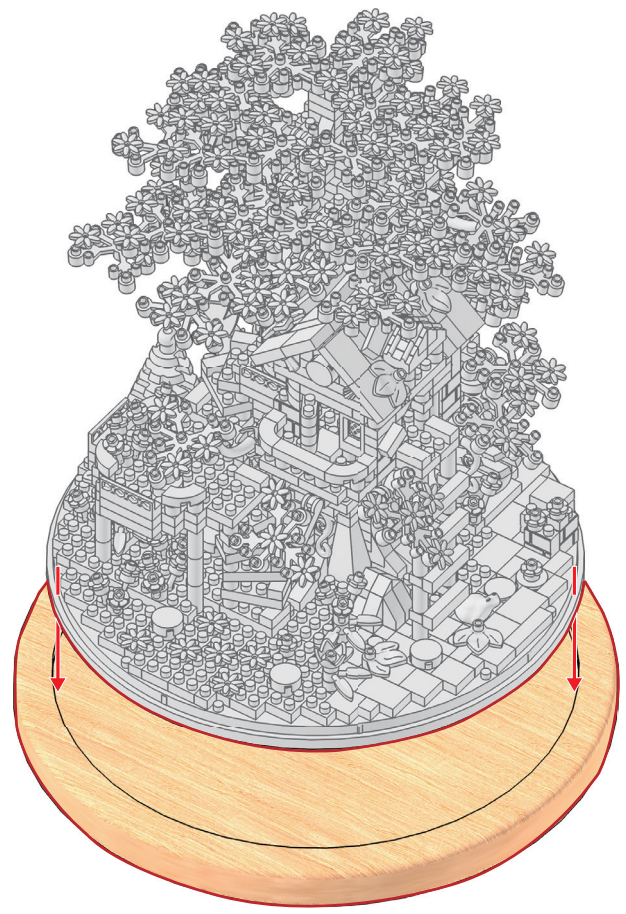
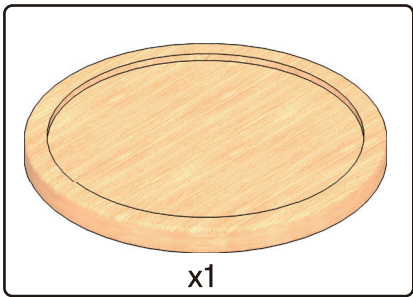

136

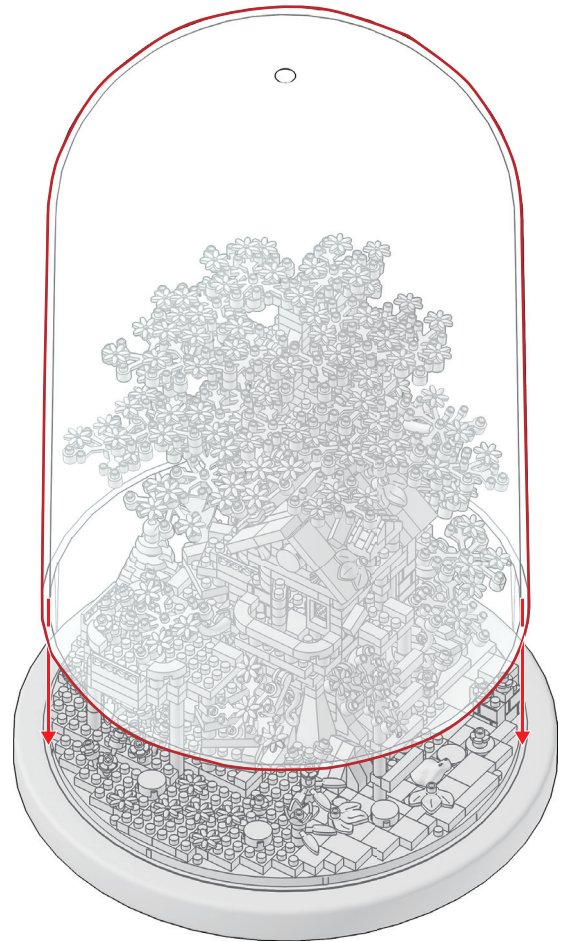
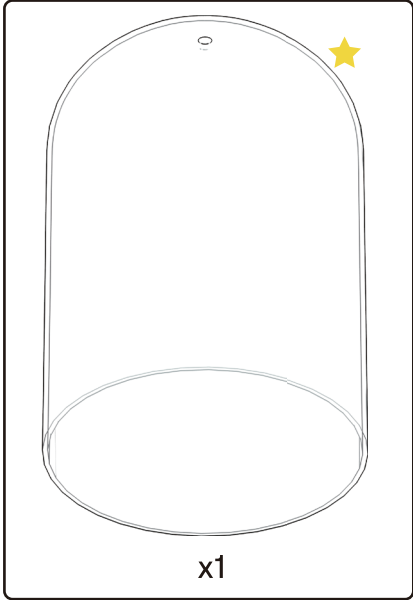

137



miniblocks

# Jacaranda Tree In Dome Instructions

10+  
years



 **WARNING: CHOKING HAZARD**  
SMALL PARTS. NOT FOR CHILDREN UNDER 3 YEARS.

ADULT ASSISTANCE IS RECOMMENDED.  
PRODUCT MAY VARY SLIGHTLY FROM IMAGE SHOWN.