

anko

**Air Fryer
AF485
User Manual**

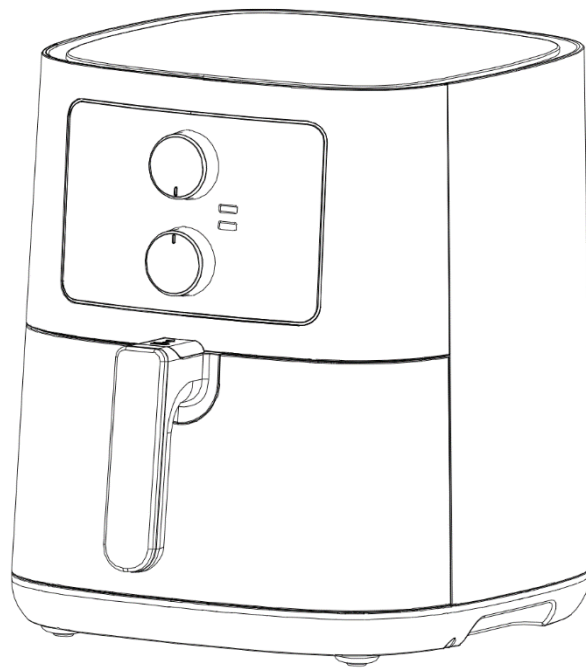

**PLEASE READ AND SAVE THESE
INSTRUCTIONS FOR FUTURE REFERENCE**

IMPORTANT SAFEGUARDS



READ ALL INSTRUCTIONS BEFORE USE.

1. Always turn the appliance OFF and disconnect from mains power when not in use, before attempting to move the appliance and before cleaning or storing.
2. Never immerse the housing which contains electrical components and heating elements, the supply cord and plug in water or any other liquid, nor rinse them under the tap.
3. To prevent electric shock and short-circuit, avoid any liquid from entering the appliance.
4. If the supply cord or plug is damaged, it must be replaced by a qualified electrician in order to avoid a hazard or the product must be disposed of.
5. This appliance is not intended for use by persons (including children) with reduced physical, sensory or mental capabilities, or lack of experience and knowledge, unless they have been given supervision or instructions concerning use of the appliance by a person responsible for their safety.
6. Children should be supervised to ensure that they do not play with the appliance.
7. Do not leave the appliance unattended when in use or when connected to mains power.

CAUTION: Do not press the basket release button to remove the basket from the pan until it is placed on a flat, firm and heat-resistant surface.

8. Surfaces may become hot during use. This is normal.
9. Do not let the cord touch hot surfaces, become knotted or hang from the edge of bench tops.
10. Do not place this appliance on or near a hot gas or electric burner, or where it could touch a heated oven.

IMPORTANT! Keep the unit clear of walls, curtains and other heat sensitive materials (leave a minimum distance of 20cm).

IMPORTANT! Do not place unit under shelving or flammable materials when in use.

11. Never overfill ingredients above the Max level mark in the basket. Keep all ingredients within the basket and do not overfill beyond the basket to prevent any direct contact with the heating element.
12. Do not move the appliance when in use.
13. Do not cover the air inlet or the air outlet when the appliance is working.
14. Do not touch the inside of the appliance while it is operating.
15. Do not use the appliance for any other purpose than described in this manual.

WARNING: FIRE HAZARD. DO NOT fill the pan with oil.

16. Do not place anything on top of the appliance when in use and when stored.
17. Before connecting the appliance to the power supply, check that the voltage indicated on the appliance corresponds with the voltage in your home. If this is not the case, DO NOT use the appliance.
18. This appliance is not intended to be operated by means of an external timer or a separate remote-control system.
19. The use of accessory attachments is not recommended by the appliance manufacturer may cause serious injury and/or damage to the appliance.
20. This appliance is for household use only, not for commercial use. Do not use this appliance for other than its intended use. Do not use in moving vehicles or boats. Do not use outdoors.

21. This appliance is intended to be **used indoors** in household and similar applications such as: staff kitchen areas in shops offices and other working environment, farmhouses, by clients in hotels, motels and other residential type environments, bed and breakfast type environments.
22. During hot air frying, hot steam is released through the air outlet. To avoid scalding keep a safe distance from steam and the air outlet.
23. Be careful of hot steam and air when you remove the pan from the appliance.
24.  **CAUTION: Hot surfaces. The baking basket/pan and air outlet become hot when the appliance in use. Always use oven gloves when handling the baking basket/pan.**
25. For cleaning, please refer to the “AFTER USING YOUR AIR FRYER” section.

IMPORTANT!

- Use the appliance only on a dry, level, stable, and heat-resistant surface only, away from any edges.
- Do not use the appliance under overhead cabinets or presses. The steam may cause damage to the cabinets or presses.
- This appliance must be connected to a three-point power outlet socket connected to Earth. If unsure check with an electrician.
- Never use the appliance with oil, this can cause a fire.
- Always unplug the power cord from mains power outlet socket when the appliance is not in use.
- Always allow the appliance to cool down completely before cleaning.

WARNING: To prevent risk of severe personal injury and/or property damage, use extreme caution when cooking.

**SAVE THESE INSTRUCTIONS.
FOR HOUSEHOLD USE ONLY.**

KNOW YOUR AIR FRYER

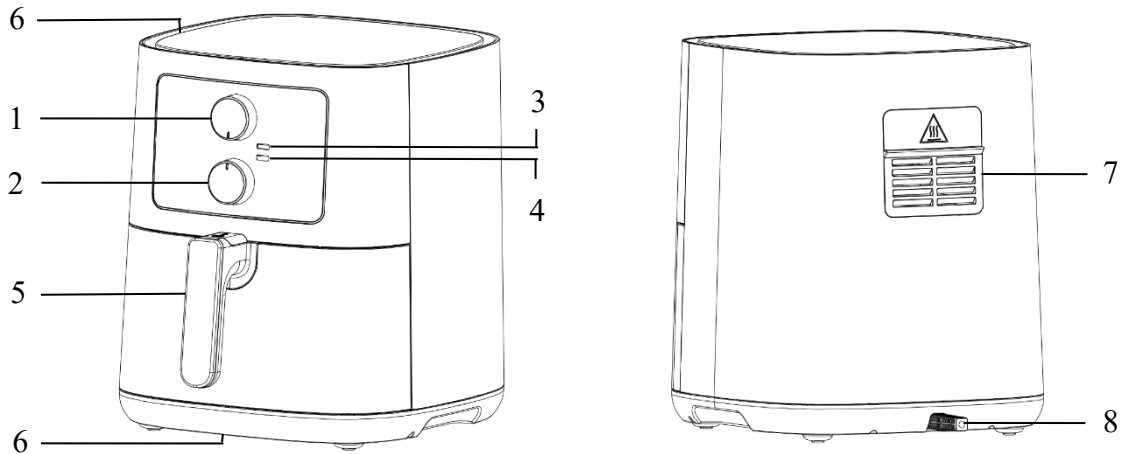

1. Temperature knob
2. Time knob
3. Orange working indication light.
4. Green heating indication light

5. Handle
6. Air inlet
7. Hot air outlet
8. Power plug & cord

INTRODUCTION

The air fryer provides an easy and healthier way of cooking your favorite foods. By applying rapid air circulation from all directions additional to a top grill, it is able to cook a variety of dishes without adding any oil or adding just a little oil to specific ingredients in the table shown in this booklet.

HOW TO USE YOUR AIR FRYER

Ensure the following before using the product:

1. Remove all the packing materials including any within the pan and basket.
2. Slide out the basket and pan, place on a flat surface, push forward the button cover, and separate the basket from the pan by pressing down on the basket release button. Clean both basket and pan with a non-abrasive sponge, with hot water and dish washing liquid. Rinse with clean water and set aside to dry.

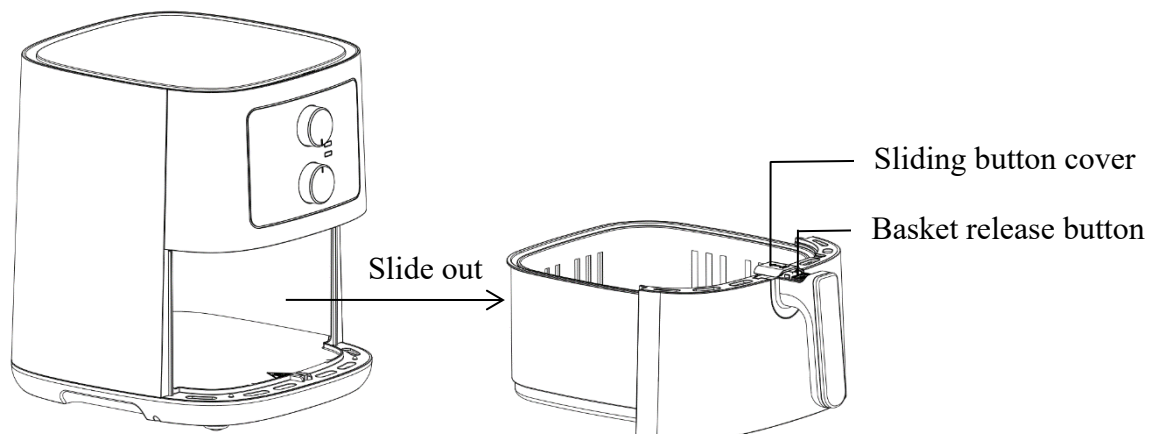

- Wipe clean the inside and outside of the appliance with a slightly dampened cloth.

Preparing for use:

- Place the appliance on a stable, horizontal, flat and heat resistant surface.

IMPORTANT! To prevent heat damage, place the appliance on a heat-resistant surface only. Not recommended to use directly on laminated / Vinyl bench top. Placing the air fryer on an insulated heat pad is recommended.

- Remove the pan and basket from the appliance and place on a flat surface.

CAUTION! After use the basket will be hot. Do not press the basket release button to remove the basket from pan until it is placed on a flat, firm and heat-resistant surface.

Using the appliance:

This appliance is able to cook a variety of dishes. Refer to the heading ‘Cooking Manual’ for selection and respective cooling times.

- Make sure both temperature & time knobs are set to “0” position.
- Connect the supply cord plug into a mains power outlet socket. The appliance is now in standby mode.
- Place the ingredients into the basket.







IMPORTANT! Do not fill beyond the MAX mark in the basket.

Do not fill more than 2.2kg food in the basket.

- Slide the pan and basket back into the appliance.

CAUTION! Never operate the appliance without the basket placed in the pan. Do not touch the external surface of the pan during use or immediately after use, the pan gets very hot. Only hold the pan by the handle.

- Rotate the temperature knob to set your desired temperature for the ingredients. There is a cooking manual in this booklet for your reference. Also, you can simply refer the suggested cooking temperature printed on the appliance as follows:

Icons	Preset	Time	Temperature
	Chips	15-20 minutes	200°C
	Chops	20-25 minutes	180°C
	Prawns	15-20 minutes	160°C
	Baking	20-30 minutes	160°C
	Drumsticks	20-25 minutes	200°C
	Steaks	10-20 minutes	180°C
	Fish	15-20 minutes	160°C

6. Rotate the time knob to set your desired cooking time. The air fryer will now start cooking and both indicator lights will illuminate.

NOTE: The temperature and time in the manual are approximates. You can adjust the time and temperature according to the volumes of the ingredients placed in the basket.

Tips: Before cooking the food, it is better to preheat the appliance without food in the basket by setting the timer to 3 minutes with temperature set at 180⁰ C.

7. For cooking of some ingredients, it may require turning the contents in the basket or adding small quantity oil in the cooking ingredients during the cooking process to ensure even cooking and avoid charring of ingredients positioned at the top of the basket. When this is needed, you can pull out the pan and basket. The appliance will stop heating when the pan and basket are pulled out automatically. After turning or adding oil, place the pan and basket back into the appliance to resume cooking.

NOTES:

The timer is not stopped when the pan and basket is pulled out. You can adjust the time and temperature setting at any time during the cooking process.

The green heating light will go OFF when the air inside reaches the set temperature. And it will light up again when the air temperature inside is lower than you're setting.

WARNING! Do not press the basket release button when tossing/turning the ingredients. Keep the pan attached. Otherwise, the pan could fall onto the floor with the possibility of striking and cause serious injuries and damage to the floor or splashing hot contents from the pan.

8. When you hear the “click” sound, the set time is elapsed, and the cooking cycle is completed. The appliance is now in standby mode with both indicator lights OFF.

9. Check if the ingredients are cooked to your satisfaction. If not, set the timer for a few more minutes until it cooked to your satisfaction.

Tips: You can set the timer for half of the cooking time. When time elapsed and a “click” sound heard, remove the pan from the appliance to toss/turn the ingredients. When placing the pan back in the appliance again, reset the timer for the balance of the cooking time.

10. When removing the pan from the appliance, only hold by the handle as other surfaces will be hot. Tip contents onto a dish directly or alternatively place the pan on a flat firm and heat-resistant surface. Press the basket release button to remove the basket and tip contents onto a dish.

Tips: To remove large individual or delicate ingredients from the basket, do not tip them out. Pick them up with a pair of tongs.

During the cooking process, oil from food will drip and be collected on the bottom of the pan. This can be cleaned at the end of the cooking process when the pan has cooled down.

11. After you have completed using your appliance, remove the plug from the wall socket immediately and allow it to cool down completely.

CAUTION!

Do not press the basket release button to remove the basket from the pan until it is placed on a flat, firm and heat-resistant surface.

Beware of escaping steam from the pan, as there is a danger of scalding.

Do not turn the basket with ingredients upside down with the pan attached when tipping the contents onto a dish. Excess oil may have collected in the pan and could drip out and cause scalding.

IMPORTANT! NEVER LEAVE THE UNIT UNATTENDED WHEN IN USE.

SETTINGS

To assist with selection of cooking times and maximum basket volumes for specific ingredients, refer to the cooking manual section in this booklet.

NOTE: Please keep in mind that the cooking manual is indicative and for your reference only.

Variation in size, shapes and brands may require an increase or decrease of cooking time and temperature setting to achieve the desired and best cooking outcome.

This type of heating technology reheats the air inside the appliance instantly, so pulling the pan briefly out of the appliance to toss/turn ingredients during cooking will barely disturb the process.

Tips:

1. Smaller ingredients usually require a shorter cooking time than larger ingredients.
2. A larger amount of ingredients requires a longer cooking time.
3. Tossing/turning smaller ingredients halfway during the cooking process optimizes the end result and can help prevent unevenly fried ingredients.
4. Do not prepare extremely greasy ingredients such as sausages with the air fryer.
5. Snacks that can be prepared in an oven can also be prepared in the fryer.
6. The optimum amount to prepare crispy chips is 500g.
7. Place a baking tin or oven dish in the air fryer basket if you want to bake a cake or quiche or if you want to fry fragile ingredients or filled ingredients.
8. You can also use the air fryer to reheat ingredients. To reheat ingredients, set the temperature to 160°C for up to 10 minutes.
9. For best results with home-made chips, soak the cut chips in water for 30 minutes to remove excess starch. Dry on kitchen paper and toss in 1/2 tablespoon of olive oil (or lightly spray with olive oil spray) until the chips are coated.
10. For a crispy home-made coating, mix fine breadcrumbs with a tablespoon of olive oil.
11. Pre-packed snacks like bread crumbed fish or chicken drumsticks only need to be coated lightly with olive oil.

AFTER USING YOUR AIR FRYER

1. Remove the supply cord plug from mains power outlet socket and allow the appliance to cool down completely before cleaning. Clean it after every use.

NOTE: Remove the pan to let the air fryer cool down faster.

CAUTION! Do not immerse the housing of the appliance in water or any other liquids when cleaning.

2. **Do not touch hot surfaces.**
3. **Do not use harsh abrasives, caustic cleaners or oven cleaners when cleaning this appliance.**
4. Wipe the outside of the appliance with a moist soft cloth.
5. Clean the pan and basket with hot water, use a non-abrasive sponge with dishwashing liquid.

NOTE: The pan and basket are dishwasher safe.

Tip: If dirt is stuck to the basket or the bottom of the pan, fill the pan with hot water and some dishwashing liquid. Leave it in the basket to soak for about 10 minutes.

6. Clean the inside of the appliance with a slightly dampened cloth and polish it with a soft dry cloth.
7. If required, lightly brush the heating element to remove any attached food residue.
8. Make sure all parts are clean and dry before storing or using it again.
9. Store the air fryer in a safe, cool, dry place. Do not place heavy objects on top of the air fryer during storage as this may damage the appliance. Keep it away from children.

COOKING MANUAL

Ingredients	Amount (g)	Cooking time (minute)	Temperature (°C)	Toss/turn needed	Extra information
Chips & potatoes					
Frozen French chips	300-800	12-20	200	√	
Frozen chunky chips or potato wedges	300-800	15-25	200	√	
Home-made French chips	300-800	20-25	180	√	Add 1/2 tbsp of oil
Fresh meat & poultry					
Steak/beef cubes	100-800	15-25	180	√	
Lamb or pork chops	150-600	16-25	180	√	
Mince patties/meat balls	100-650	12-20	180	√	
Chicken wings/drumsticks/thigh/breast	100-900	20-30	180	√	
Chicken thigh	400-1200	30-45	200	√	
Fish and Shrimp					
Fish (fresh)	150-450	12-20	160	√	
Shrimp (fresh)	500	20	160	√	
Snacks					
Spring rolls	100-400	8-10	200	√	Use oven-ready
Frozen chicken nuggets	150-850	18-25	180	√	Use oven-ready
Frozen bread crumbed cheese snacks	100-200	8-10	180	√	Use oven-ready
Sausage roll	100-700	13-18	200	√	
Baking					
Cake	300	30	160		Use baking tin
muffins	300-600	25-30	160		Use baking tin/ramekin
Tarts/souffle	360	20	160		Use baking tin/ramekin
Pizza	500-800	20-25	180		Use pizza pan

TROUBLESHOOTING

Problem	Possible cause	Solution
The fryer doesn't work.	The appliance is not connected to mains power outlet socket.	Connect the appliance into a mains power outlet socket.
The ingredients fried in the fryer are not done.	The amount of ingredients in the basket is too high.	Place smaller batches of ingredients in the basket. Smaller batches are fried more evenly.
	The set temperature is too low.	Set the temperature to the required temperature setting (refer to the above cooking manual).
	The preparation time is too short.	Set the timer to the required preparation time.
The ingredients are fried unevenly in the fryer.	Certain types of ingredients need to be tossed/turned halfway during the cooking process.	Ingredients that lie on top of or across each other (e.g., fries) need to be tossed/turned halfway during the cooking process (refer to the cooking manual).
Fried snacks are not crispy when they come out of the fryer	You used a type of snacks meant to be prepared in a traditional deep fryer.	Use oven snacks or lightly brush some oil onto the snacks for a crisper result.
Can't slide the pan into the appliance properly	There are too many ingredients in the basket.	Do not fill the ingredients over the "MAX" mark in the basket.
	The basket is not placed in the pan properly.	Push the basket down into the pan until you hear a 'click'.
White smoke comes out from the appliance.	You are preparing greasy ingredients.	When you fry greasy ingredients in the fryer, a large amount of oil will leak into the pan. The oil produces white smoke, and the pan may heat up more than usual. This does not affect the appliance or the end result.
	The pan still contains grease residues from previous use.	White smoke is caused by grease heating up in the pan. Make sure you clean the pan properly after each use.
Fresh chips are fried unevenly in the fryer.	You did not use the right potato type.	Use fresh potatoes and make sure that they stay firm during frying.
	You did not rinse the potato chips properly before you fried them.	Rinse the potato chips properly to remove starch from the outside of the fries.
Fresh chips are not crispy when they come out of the fryer	The crispiness of the chips depends on the amount of oil and water in the fries.	Make sure to dry the potato chips properly before adding the oil.
		Cut the potato chips smaller for a crispier result.
		Add slightly more oil for a crisper result.

TECHNICAL SPECIFICATION

Voltage: 220-240Va.c. 50-60Hz

Power: 1800W

MAX. weight of food should not exceed 2.2kg.

12 Month Warranty

Thank you for your purchase from Kmart.

Kmart Australia Ltd warrants your new product to be free from defects in materials and workmanship for the period stated above, from the date of purchase, provided that the product is used in accordance with accompanying recommendations or instructions where provided. This warranty is in addition to your rights under the Australian Consumer Law.

Kmart will provide you with your choice of a refund, repair or exchange (where possible) for this product if it becomes defective within the warranty period. Kmart will bear the reasonable expense of claiming the warranty. This warranty will no longer apply where the defect is a result of alteration, accident, misuse, abuse or neglect.

Please retain your receipt as proof of purchase and contact our Customer Service Centre on 1800 124 125 (Australia) or 0800 945 995 (New Zealand) or alternatively, via Customer Help at Kmart.com.au for any difficulties with your product. Warranty claims and claims for expense incurred in returning this product can be addressed to our Customer Service Centre at 690 Springvale Rd, Mulgrave Vic 3170.

Our goods come with guarantees that cannot be excluded under the Australian Consumer Law. You are entitled to a replacement or refund for a major failure and compensation for any other reasonably foreseeable loss or damage. You are also entitled to have the goods repaired or replaced if the goods fail to be of acceptable quality and the failure does not amount to a major failure.

For New Zealand customers, this warranty is in addition to statutory rights observed under New Zealand legislation.