

Assembly Instructions

















43228706 FRASER RATTAN CABINET

WARNING: DO NOT STAND, SIT OR LEAN ON THIS UNIT. DO NOT USE THIS UNIT AS A STEP LADDER OR AS A CHOPPING SURFACE. KEEP AWAY FROM CHILDREN AND BABIES. ADULT ASSEMBLY REQUIRED. USE ONLY ON A FLAT SURFACE. DO NOT USE THIS UNIT UNLESS ALL BOLTS AND SCREWS ARE FIRMLY SECURED.

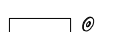

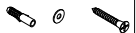
CARE INSTRUCTIONS: TO BE ASSEMBLED ON A CLEAN, DRY AND SMOOTH SURFACE. WIPE CLEAN WITH A SOFT DAMP CLOTH. NEVER USE SCOURERS, ABRASIVES OR CHEMICAL SOLVENTS. CHECK AND TIGHTEN ALL PARTS REGULARLY. KEEP AWAY FROM MOISTURE AND DIRECT SUNLIGHT. STORE IN A DRY PLACE. FOR INDOOR AND DOMESTIC USE ONLY.

MAXIMUM SAFE LOAD: 10KGS FOR TOP PANEL,5KGS FOR SHELF.

1 Hardware List

	A	M6x35mm	6pcs		J		2pcs
	B	Ø15x9.5mm	6pcs		K	M3x12mm	4pcs
	C	Ø6x30mm	15pcs		L		1pc
	D	M4x35mm	4pcs		M		8pcs
	E	M7x50mm	5pcs		N	M3x16mm	8pcs
	F		4pcs		O	M4x12mm	2pcs
	G	M4x12mm	24pcs		P	M4x35mm	2pcs
	H		4pcs		Q	M3.5x12mm	4pcs
	I		2pcs		R		5pcs

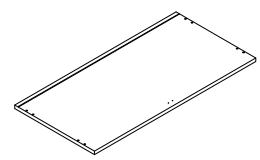
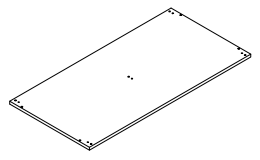
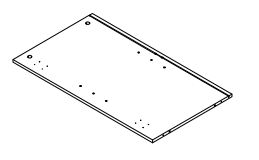
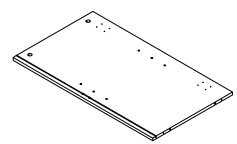
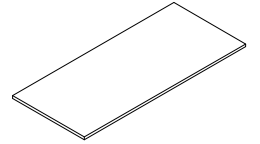
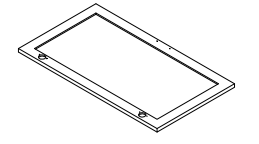
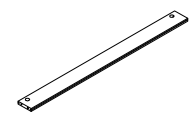
3

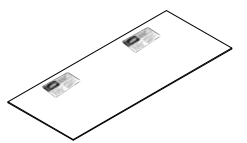
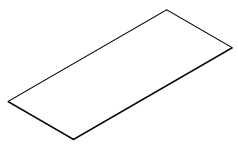

							
①	1PC	②	1PC	③	1PC		
							
④	1PC	⑤	1PC	⑥	2PCS		
							
⑦	1PC	⑧	5PCS	⑨	1PC		
							
⑩	1PC						

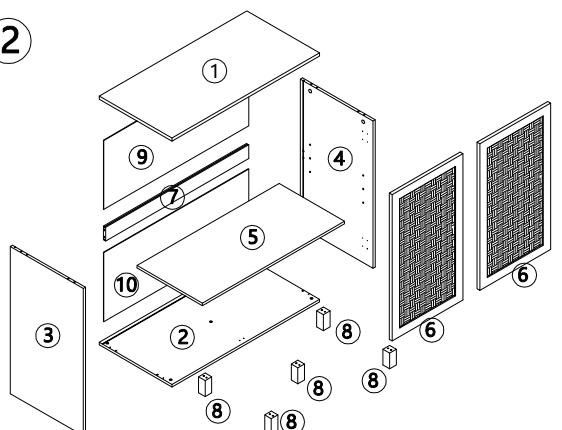
2





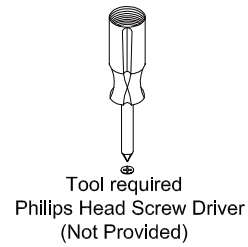
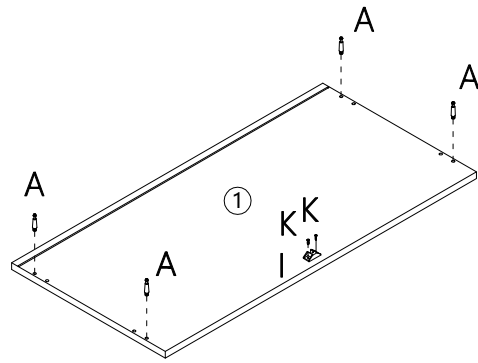

Do not tighten the screws fully during assembly. Fully tighten screws after the final assembly steps.

STEP 1:

 A x4
 I x1
 K x2



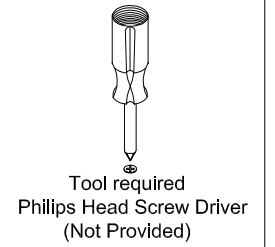
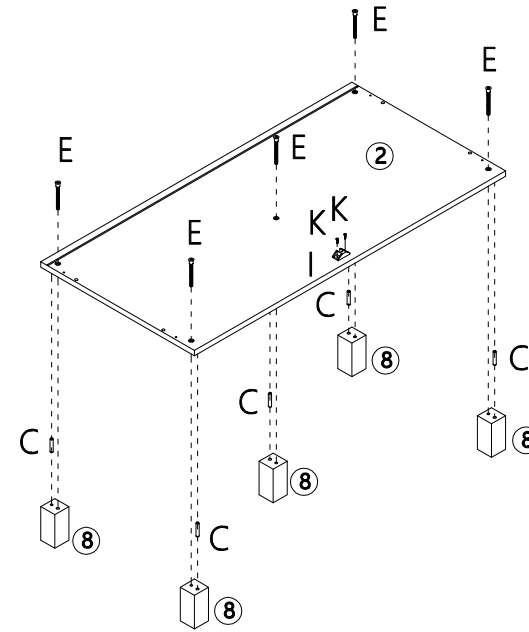

STEP 2:

 C x5
 E x5
 I x1
 K x2



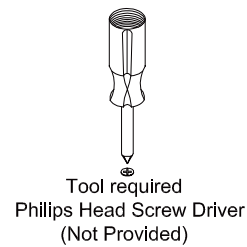
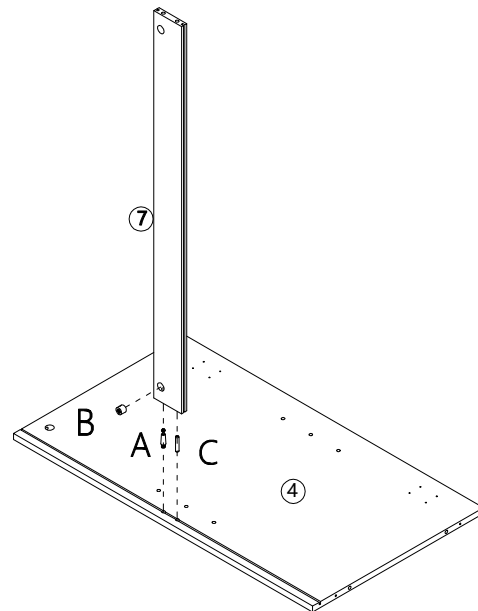

STEP 3:

 A x1
 B x1
 C x1



STEP 4:

 A x1
 B x1
 C x1

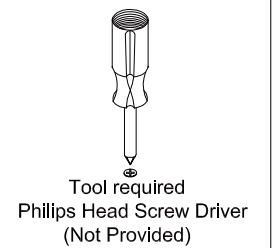
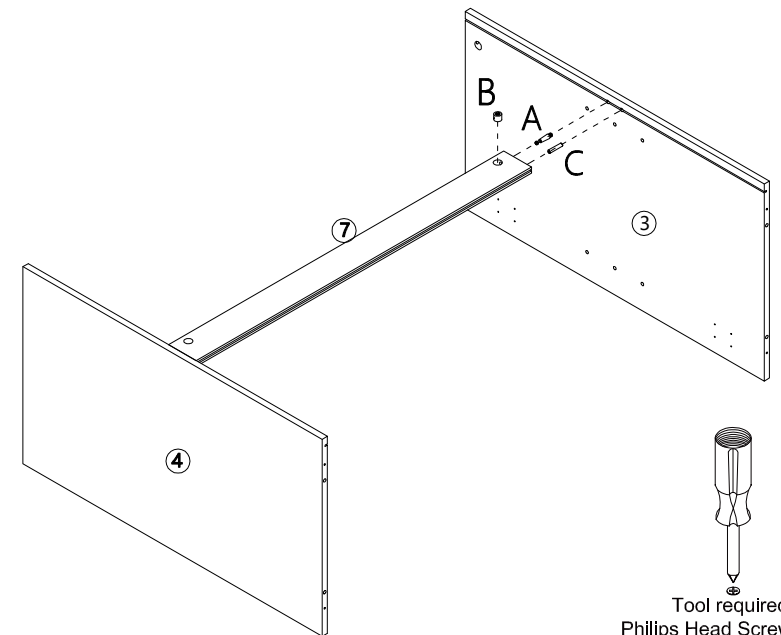

STEP 5:

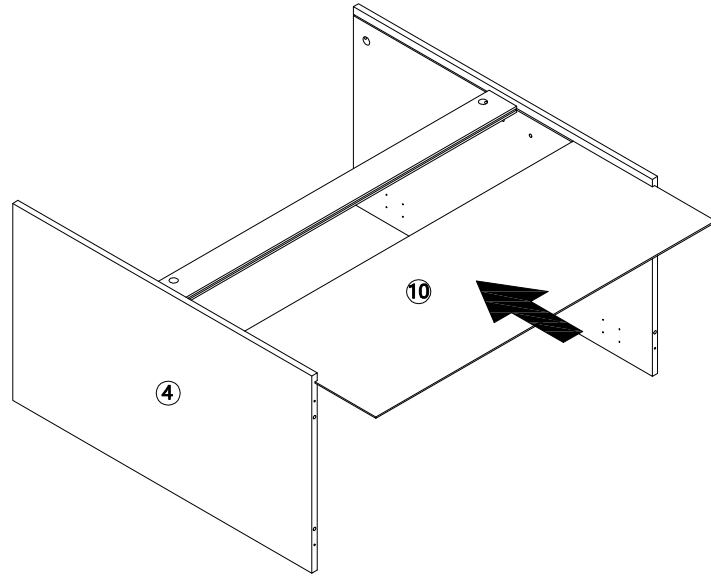

STEP 6:

- C x4
- D x4
- R x5

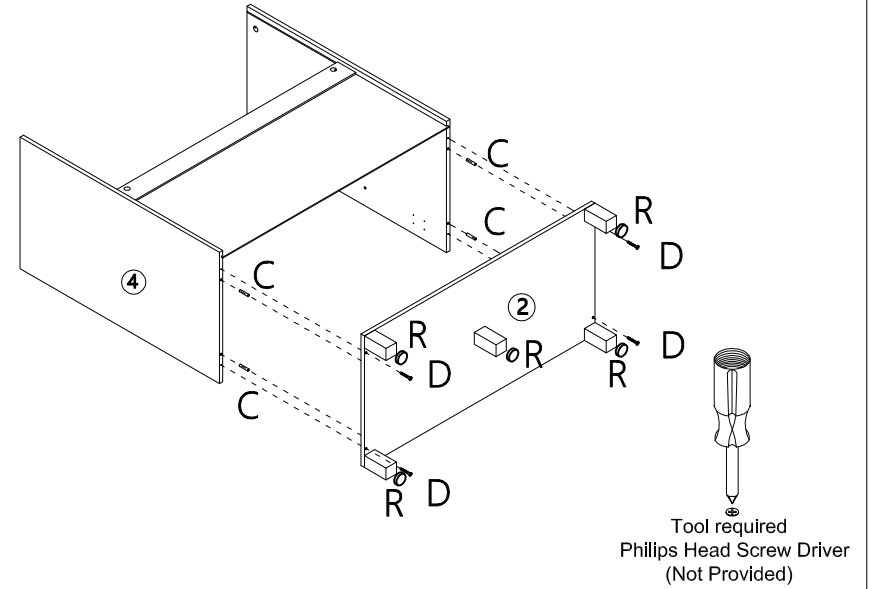

STEP 7:

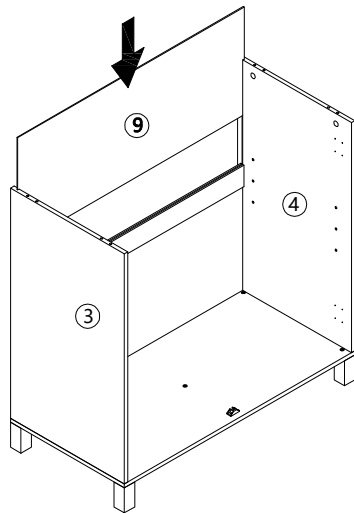

STEP 8:

- B x4
- C x4

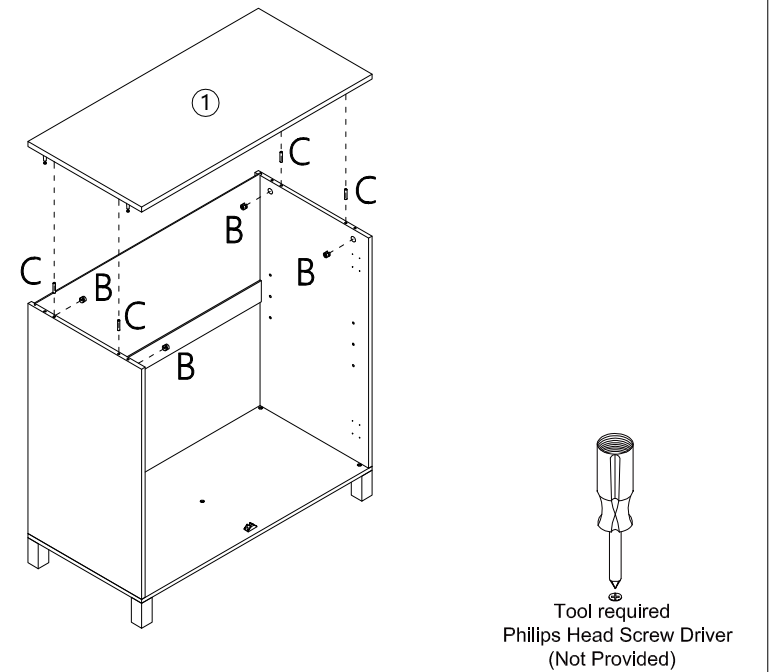

STEP 9:

- J x2
- Q x4

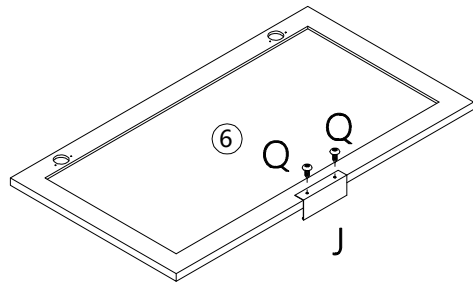

x 2



Tool required
Philips Head Screw Driver
(Not Provided)

STEP 10:

- F x4
- G x24
- H x4

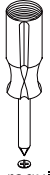
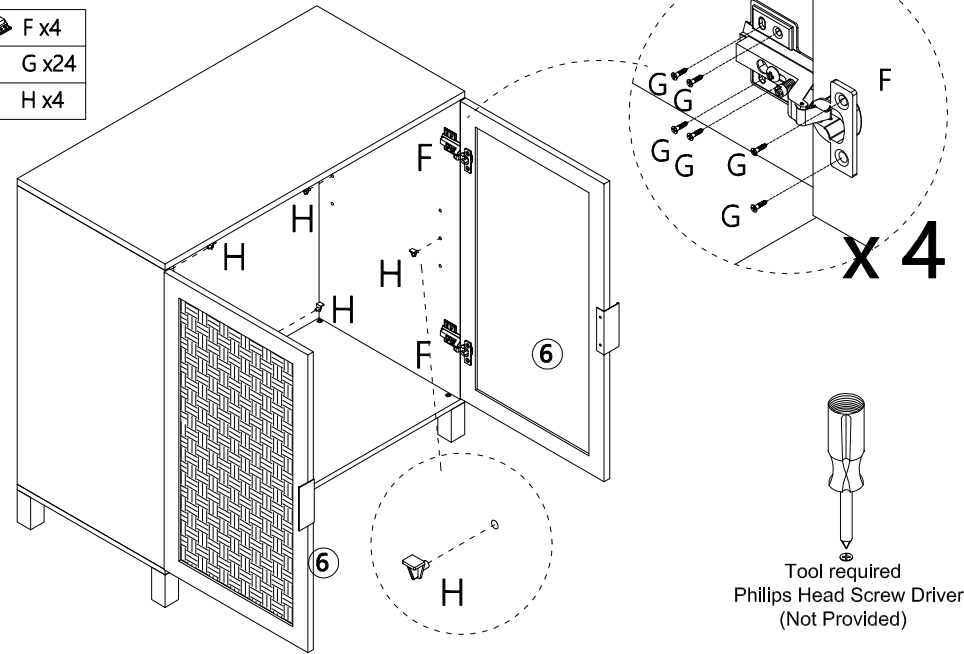

Tool required
Philips Head Screw Driver
(Not Provided)

STEP 11:

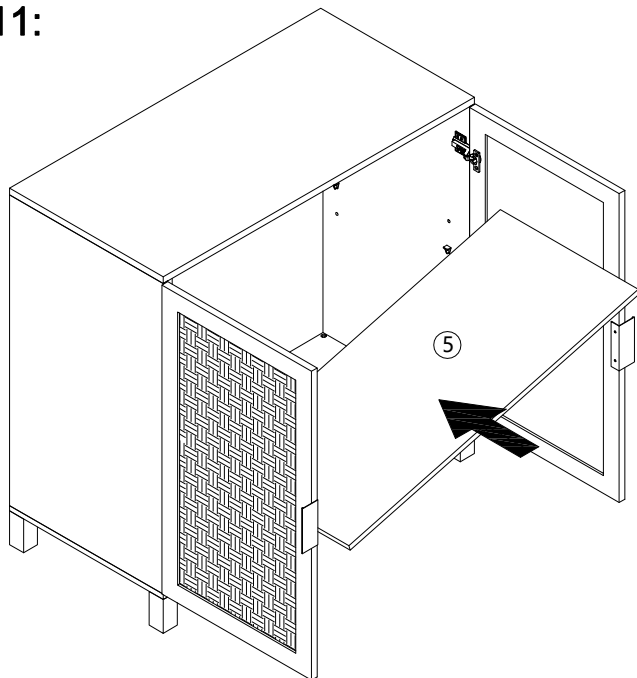

STEP 12:

- M x8
- N x8
- O x2

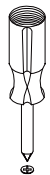
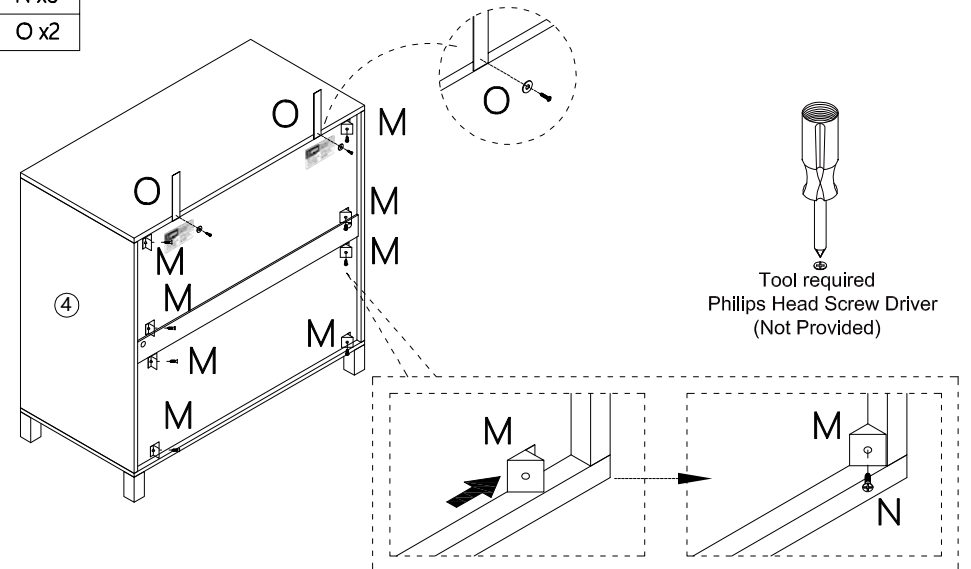

Tool required
Philips Head Screw Driver
(Not Provided)

STEP 13:

  P x2

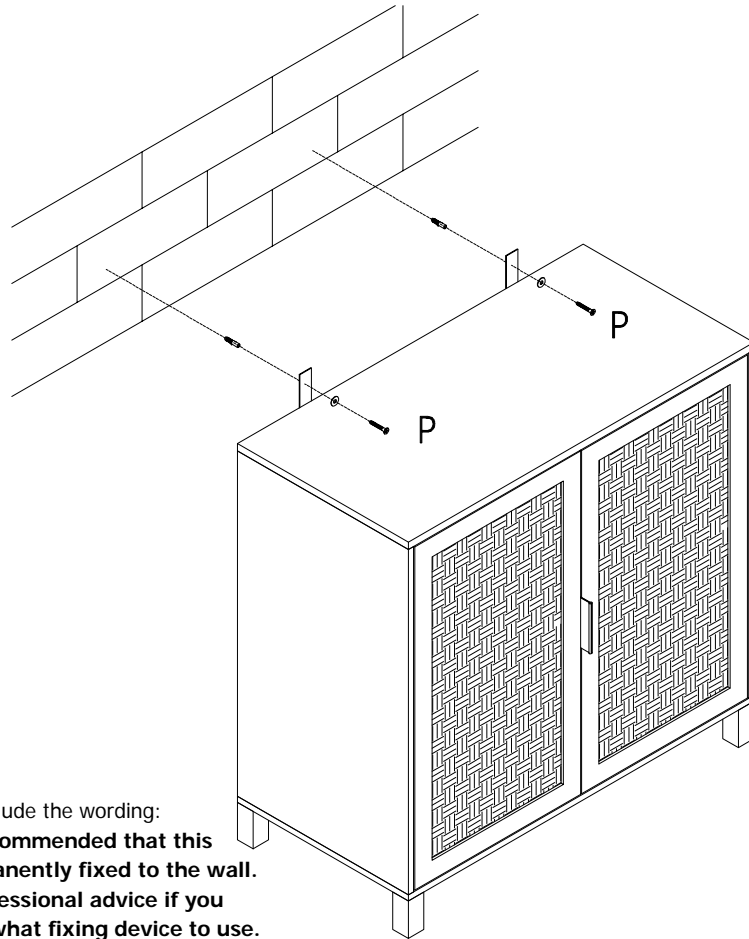

User instructions should include the wording:

- **It is strongly recommended that this product is permanently fixed to the wall.**
- **Please seek professional advice if you are in doubt of what fixing device to use.**
- **Regularly check that anchors are securely maintained.**
- **Stability of tall items may be affected by thick pile carpet or uneven floors .**
- **Do not place unanchored televisions on furniture .**

CAUTION: for your safety when attaching the anchor fixings, please note the following:

- **Check any electrical wires or plumbing inside the wall before drilling any holes (if you are unsure please seek professional advice from a qualified tradesperson).**



Tool required
Philips Head Screw Driver
(Not Provided)



WARNING: PLEASE SECURE YOUR FURNITURE WITH THE SUPPLIED WALL FIXING. SCAN THE CODE FOR MORE INFORMATION.

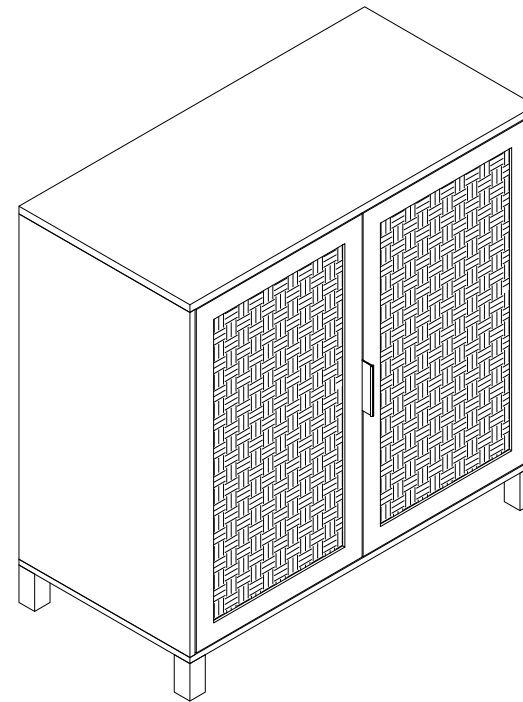

Hinger Adjustment Tips

Noted: The door might be scraping, bumping, misaligned when first assembly.

Please follow the below tips:

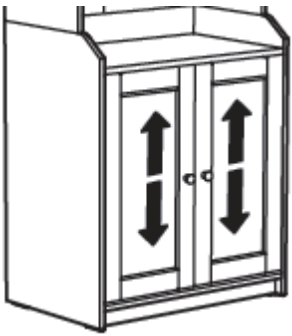

Adjust the door up and down

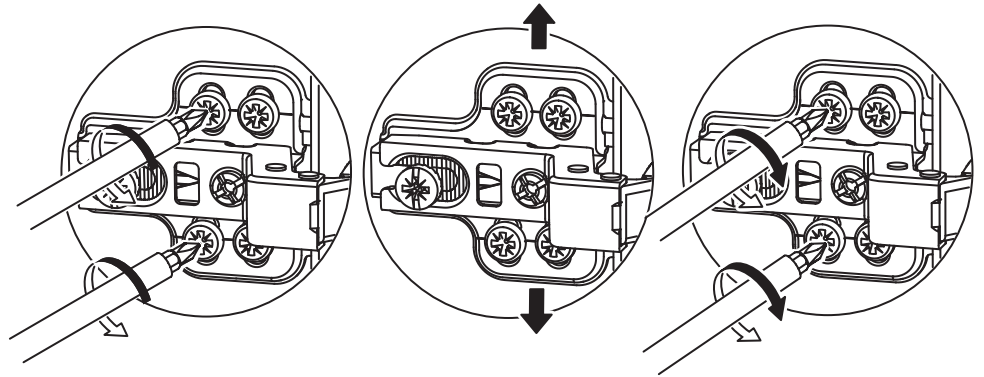

1. Loosen the two mounting screws on both hinges, but only slightly. ...
2. Gently close the cabinet door.
3. With the door still closed, adjust the cabinet door to the desired height.
4. Open the cabinet door again, being careful not to jostle the door out of position.
5. Retighten the screws by hand.

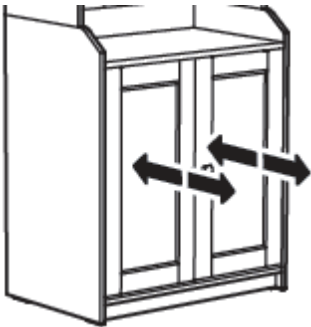

Move the door in and out

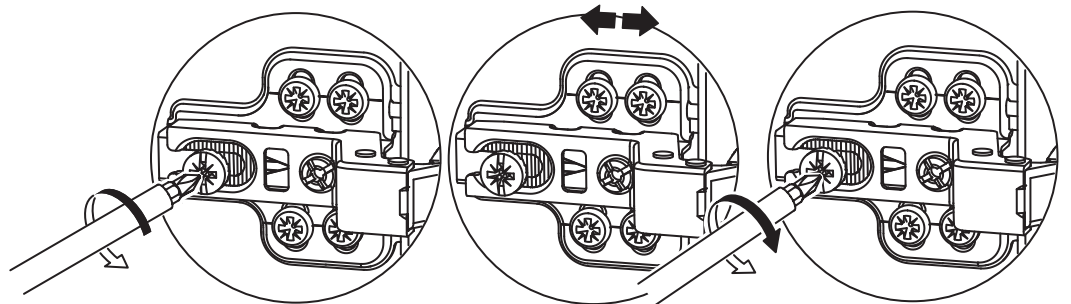

If the door doesn't meet the box at the top, adjust the top hinge toward the cabinet and/or adjust the bottom hinge away from the cabinet. If the door is gapped at the bottom, do the reverse.

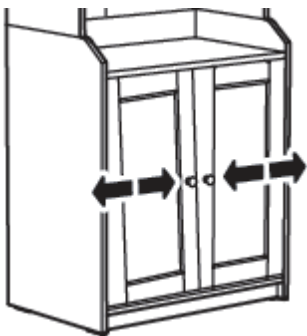

Move the door right or left

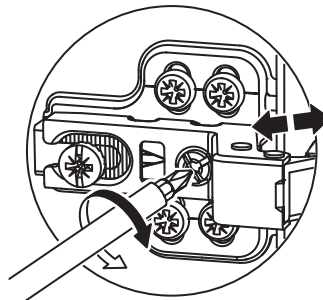

You can adjust one or both hinges on each door, depending on how much correction it needs. If the door seems to be tilting down to the right, turn the side-to-side screw on the top hinge so the hinge pulls closer to the side of the cabinet box, moving the top of the door to the left.