

anko

Air Fryer Oven

AF1006

User Manual

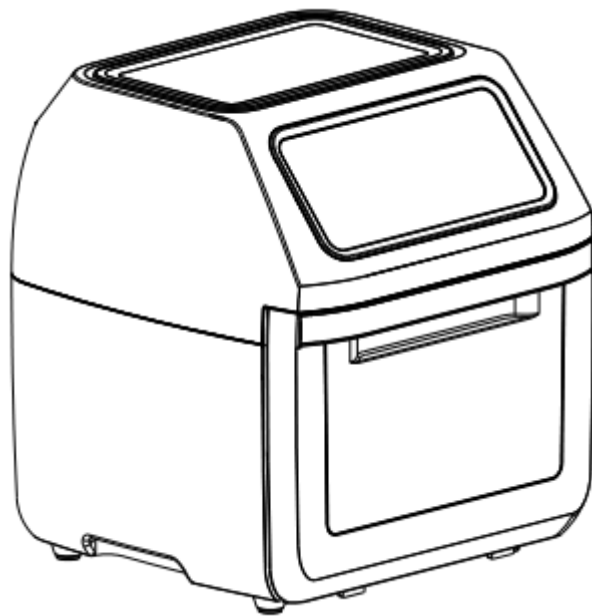

**PLEASE READ AND SAVE THESE
INSTRUCTIONS FOR FUTURE REFERENCE**

IMPORTANT SAFEGUARDS

When using any electrical product, always follow these basic safety precautions:



READ ALL INSTRUCTIONS BEFORE USE.

1. Read all instructions before using this appliance.
2. Always turn the appliance OFF and disconnect from mains power when not in use, before attempting to move the appliance, before cleaning or storing.
3. Never immerse the appliance, the supply cord and plug in water or any other liquid, nor rinse them under the tap.
4. To prevent electric shock and short-circuit, avoid any liquid from entering the appliance.
5. If the supply cord or any part is damaged, it must be replaced by a qualified electrician in order to avoid a hazard or the product must be disposed.
6. Unplug from outlet when not in use and before cleaning. Allow the appliance to cool down before putting on or taking off parts.
7. This appliance is not intended for use by persons (including children) with reduced physical, sensory or mental capabilities, or lack of experience and knowledge, unless they have been given supervision or instruction concerning use of the appliance by a person responsible for their safety.
8. Do not leave the appliance unattended when in use. Children should be supervised to ensure that they do not play with the appliance.
9. Surfaces may become hot during use. This is normal.
10. Do not let the cord touch hot surfaces, become knotted or hang from the edge of bench tops.
11. Do not place this appliance on or near a hot gas or electric burner, or where it could touch a heated oven.
12. Keep the appliance clear of walls, curtains and other heat sensitive materials (leave a minimum distance of 20cm at each direction). Do not place the appliance under shelving or flammable materials when in use.
13. Do not move the appliance when in use.
14. Do not cover the air inlet or the air outlet when the appliance is working.
15. Do not touch the inside of the appliance while it is working.
16. Do not use the appliance for any other purpose than described in this manual.
17. Do not place anything on top of the appliance when in use and when stored.
18. Before connecting the appliance to the power supply, check that the voltage indicated on the appliance corresponds with the voltage in your home. If this is not the case, DO NOT use the appliance.
19. This appliance is not intended to be operated by means of an external timer or a separate remote-control system.
20. The use of accessories not recommended by the appliance manufacturer may cause serious injury or damage to the appliance.
21. This appliance is for household use only. Do not use this appliance for other than its intended use. Do not use in a moving vehicles or boats. Do not use outdoors.

22. This appliance is not intended to be used in environments such as staff kitchen in shops, offices, farms or other work environments. Nor is it intended to be used by clients in motels, bed and breakfast and other residential environments.
23. During hot air frying, hot steam is released through the air outlet. Keep yourself at a safe distance from steam and the air outlet. Also, be careful of hot steam and air when operating.
24. Make sure the ingredients prepared in this appliance come out golden yellow instead of dark or brown.



CAUTION: Hot surfaces! The appliance and accessories become extremely HOT during cooking process. Do not touch the accessories during and immediately after cooking. Only hold the appliance by the handle and use caution when removing the accessories and food from the appliance. Always wear oven mitts or use the fetch tool when handling potentially hot accessories and foods. Allow it to cool down completely before cleaning.

IMPORTANT!

- Use the appliance only on a dry, level, stable, and heat-resistant surface only, away from any edges.
- Do not use the appliance under overhead cabinets or presses. The steam may cause damage to the cabinets or presses.
- Do not place the unit close to flammable materials, heating units or wet environments.
- This appliance must be earthed.
- Never use the appliance with oil.
- Always unplug the power cord from wall outlet socket when the appliance is not in use.
- Always allow the appliance to cool down completely before cleaning.
- Do not replace with other parts that are not designed specifically for this appliance.
- Do not put any other cooking pans in the appliance.
- If a lot of smoke is escaping from the air vent during operation, unplug the unit and do not use.
- Do not move the unit whilst in operation. Allow the appliance to cool down completely before moving.
- Any repairs to the product must be carried out by a qualified electrical person only.
- Do not disassemble the unit on your own or replace any parts.
- If the power cord is damaged, do not use.
- Keep the unit out of reach of children during use or when stored.
- Keep away from the air outlet or where heat or steam is being released.
- Make sure the appliance is always clean prior to cooking.
- It is normal for some smoke to escape from the unit when heating for the first time. This should subside after few minutes of use.

WARNING: To prevent risk of severe personal injury and/or property damage, use extreme caution when cooking.

 **CAUTION!**

- **Do not cover the air inlet and outlet opening while the appliance is operating.**
- **Never touch the inside of the appliance while it is operating.**

**SAVE THESE INSTRUCTIONS FOR FUTURE
REFERENCE.**

FOR HOUSEHOLD USE ONLY.

RYER OVEN

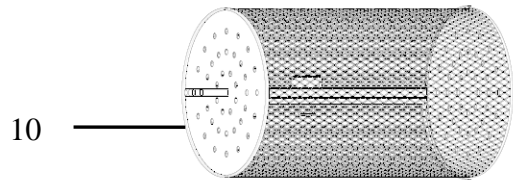
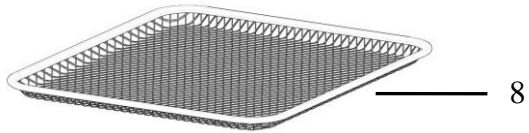
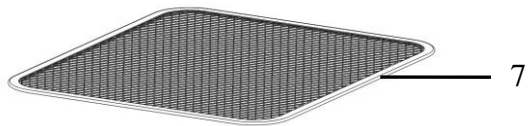
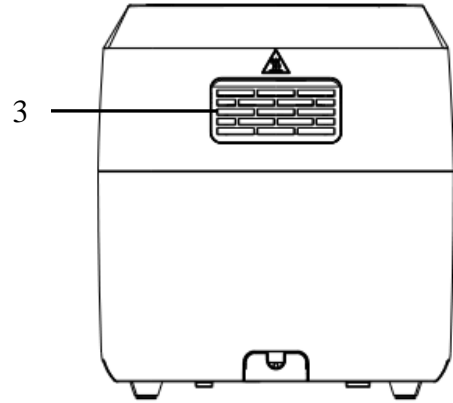
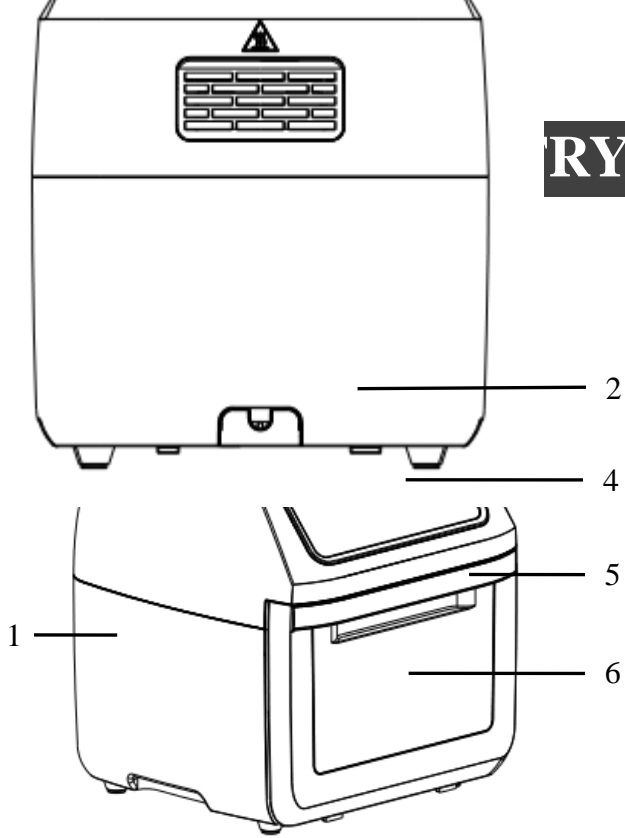

1. Main unit
2. Air inlet
3. Hot air outlet
4. Control panel
5. Door handle
6. Door

7. Heating element protection cover
8. Air flow racks (3pcs)
9. Drip tray
10. Rotisserie basket
11. Rotisserie fork set
12. Fetch tool

IMPORTANT!



Please make sure that your appliance is received with the right components shown above. Check everything carefully before use. If any parts are missing or damaged, do not use. Return the product to Kmart for replacement.

INTRODUCTION

The air fryer oven provides an easy and healthier way of cooking your favorite foods. By applying rapid air circulation from all directions additional to a top grill, it is able to cook a variety of dishes without adding any oil or cook with mist of oil.

BEFORE FIRST USE

Note: When using the appliance for the first time, carefully remove all internal and external packaging, protective film and accessories.

- Clean the main unit with a damp cloth or sponge. Wipe dry with a soft dry cloth.
 **WARNING! Do not immerse the main unit in water or any other liquids to clean.**
- Wash the accessories with soapy water. Dry all components thoroughly before use.
 **WARNING! This is an oil-free fryer that works on hot air. Do not fill with oil, frying fat or any other liquid. Fire hazard or personal injury could result!**

HOW TO USE THE ACCESSORIES

Heating Element Protection Cover

- The protection cover can prevent the food from contacting the heating element.
- Let the side with wire handle face down, slide along the top plastic shelf near the heating element in the oven to install the protection cover. Take out the protection cover by pulling the wire handle.

Air Flow Racks

- The air flow racks can be used not only for dehydration but also to cook crispy snacks or reheat foods like pizza.
- Slide along the rack shelf to install or take out the air flow racks.

NOTE: The maximum weight on the air flow rack must not exceed 1.5Kg.

Rotisserie Fork Set

- The rotisserie fork set is used for roasting large meat or whole chicken.
- Install a fork on the shaft. Force shaft lengthwise through meat/chicken in center. Install another fork on the shaft. Slide both forks into meat/chicken and adjust the meat/chicken to the middle of the shaft, then drive the screws to lock the forks in position. You can adjust the forks closer to the

middle if needed but never outwards to the screw grooves of both ends.

NOTE: Make sure the meat or chicken is not too large to rotate freely in the oven. Maximum 1KG. For a better cooking experience, use yarn to tie the chicken to make sure enough space for rotation.

- To install the rotisserie fork set, put the cuboid end into the hole on the left side, put another side onto the rotating shelf on the right side.

Rotisserie Basket

- Great for fries, roasting nuts and other snacks.
- Use the hasp to open and lock the rotisserie basket.
- To install the rotisserie basket, put the cuboid end into the hole on the left side, put another side onto the rotating shelf on the right side.

Fetch Tool

- Used to remove the rotisserie basket or fork set from the appliance.
- Place the fetch tool under the shaft at both side of the rotisserie basket or fork set, then gently extract the rotisserie basket or fork set out.

Drip Tray

- Cook with the drip tray for easy clean ups.
- Put the drip tray into the bottom of the appliance when in use. It is easy to take out for cleaning.

Door

- The door is detachable for easy cleaning.
- Open the door at a 30° angle from the appliance and gently put on or take off the door.
- The appliance will not work with the door open.

HOW TO USE THE CONTROL PANEL

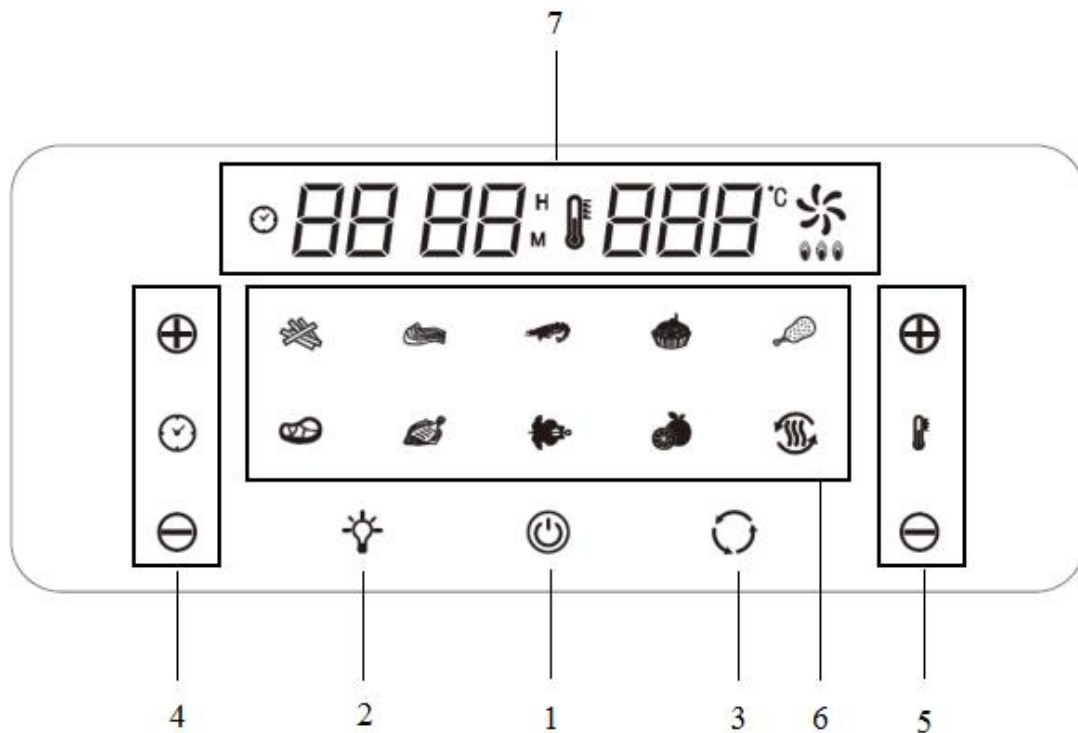

1. Power Button

- Once the appliance is plugged in, the Power Button will light up and the appliance is in standby mode.
- Long-touch the power button, the full control panel will be illuminated. Choose the right preset or set the appliance manually, then touch the power button to start cooking process. If no operation within 1 minute, the control panel will switch OFF automatically.
- Touch the power button to start cooking after the right preset function selected or temperature and time set manually.
- Long-touch the power button at any time during the cooking process, the control panel will switch OFF immediately and the appliance will shut down at the same time, but the fan will continue running for 20 seconds, this is normal.

2. Internal Lamp

- With the help of the internal lamp, you can check the cooking progress.
- Touch the light button, the icon will start to blink and the internal lamp will be illuminate. The lamp will illuminate for 30 seconds during the cooking process.
- Internal lamp will illuminate for 3 minutes when you open the door in standby mode. The internal lamp will automatically turn OFF when the oven door is closed.

3. Rotation Button

- Touch the rotation button when cooking using the Rotisserie basket or fork set. This function can be used with any preset. The icon will blink while the function is in use. You can stop this function by

touching the blinking icon at any time.

4. Time Control Buttons

- Time control buttons enable you to select exact cooking time by hour or minute. For dehydrating function, you can increase or decrease time by 30minutes from 2 hours to 24 hours. And for all the other functions, you can increase or decrease time by 1 minute, from 1minute to 60 minutes.











5. Temperature Control Buttons

- Temperature control buttons enable you to raise or lower cooking temperature by 5°C starting from 65°C to 200°C under normal condition, 30°C to 80°C under preset function on dehydrator, and 40°C to 70°C under preset function on defrost.

6. Preset Functions

- The preset functions will help you to start cooking efficiently.
- Select any of the icons, this will automatically set the Time and Temperature to a default setting for the selected food type. You can over-ride the default presets with time and temperature buttons. The icons will keep blinking and switch off until the cooking process completed.
- The preset settings are as follows:

Note: use the below table for reference only. Actual cooking time and temperature may have to be adjusted depending on the quantity or size.

Icons	Preset	Time	Temperature
	Chips	18 minutes	200°C
	Chops	20 minutes	200°C
	Prawns	12 minutes	160°C
	Baking	30 minutes	160°C
	Drumsticks	25 minutes	180°C
	Steaks	12 minutes	200°C
	Fish	13 minutes	200°C
	Chicken	40 minutes	190°C
	Dehydrator	4 hours	70°C
	Defrost	12 minutes	70°C

7. Digital Display

The Digital Display shows the time, temperature, fan and heater working status.

PREPARE FOR USE AIR FRYER OVEN

- Place the appliance on a stable, level, horizontal and heat resistant surface.

IMPORTANT! Do not place the appliance on non-heat-resistant surface. Do not place or use the appliance on a laminated / Vinyl bench top. To prevent heat damage, placing the air fryer oven on an insulated heat pad is recommended.

NEVER put anything on top of the appliance.

NEVER cover the air vents on the top and back of the cooking Unit.

NEVER fill any cooking vessel with oil or liquid of any kind. This Unit cooks with hot air only.

NEVER use the Oven Door as a place to rest a hot Fry Basket filled with food. The Hot Fry Basket could damage the Oven Door or cause the Unit to tip-over. Personal injury could result.

 **Warning! Forks, Skewers and other metal parts with this appliance are sharp and will get extremely hot during use. Special care should be taken to avoid personal injury. Wear protective oven mitt or use fetch tool.**

COOKING WITH YOUR AIR FRYER OVEN

- Select the right cooking accessory (air flow rack, rotating basket or fork set) for your food.
- Put the food on/into /force through the cooking accessory, put the accessory with food into the air fryer oven on the right position. And close the door to the right position.
- Connect the plug of the appliance into an earthed power outlet socket. The power button will light up.
- Long-touch the power button to illuminate the control panel.
- Select a preset function or set the time and temperature manually, then touch the power button to start cooking. Touch rotation button when cooking anything using the Rotisserie basket or fork set. Touch the light icon to check the cooking process if needed.

NOTE: You may open the door to check at any time during the cooking process, the appliance will pause when the door is opened or powered off. The appliance will continue cooking when the door is closed or powered ON again within 2 hours. If the door is opened or powered OFF for more than 2 hours during the cooking process, the appliance will return to standby mode automatically.

 **Warning!** During the cooking process, accessories will become very hot. When you remove it to check, make sure you have a trivet or a heat resistant surface nearby to put it on. **NEVER** place the accessories directly on a counter / bench top or table.

- You can reset the time and temperature during cooking process according to the actual condition.
- When the cooking process has completed, the appliance will automatically stop heating with 5 beep-beep sounds. The fan will keep working 20 seconds more.

- Open the door and take out the accessories with food.

CAUTION! The appliance and accessories are extremely hot! Always use oven mitt or the fetch tool. Handle with care to avoid injury.

Tips:

- Foods that are smaller in size usually require a slightly shorter cooking time than larger ones.
- Turning foods halfway during the cooking process will assure that all the pieces are evenly cooked.
- Misting a bit of vegetable oil to fresh potatoes is suggested for a crispier result. When adding a little oil, do it only before the start of the cooking process.
- Snacks normally cooked in an oven can also be cooked in the air fryer oven.
- Place a baking tin in the air fryer oven when baking cake, quiche, fragile or filled foods.
- You can also use the air fryer oven to reheat foods. Simply set the temperature to 150°C for up to 10 minutes.
- Cut into thin slices of about 5mm, and evenly arrange the air flow racks in the oven. It is best to keep a little space in the middle to facilitate the circulation of hot air.

COOKING CHART

Category	Food	Amount (g)	Time (min.)	Temperature (°C)
Potato & chips	Thin frozen chips	600-700	15-20	200
	Thick frozen chips	600-700	20-25	200
	Potato gratin	800-1000	25-30	200
Meat & Poultry	Steak	500-800	10-15	180
	Pork chops	500-800	15-20	200
	Hamburger	400-800	10-15	180
	Sausage roll	400-800	13-15	200
	Drumsticks	400-800	25-30	180
	Chicken breast	400-800	15-20	180
	Chicken	500-1000	30-40	190
Snacks	Spring rolls	500-800	8-10	200
	Frozen chicken nuggets	500-1000	6-10	200
	Frozen fish fingers	500-800	6-10	200
	Frozen bread crumbed cheese snacks	500-800	8-10	180
	Stuffed vegetables	400-800	10	160
	Dried fruit	/	240	35
Baking	Cake	800	20-25	160
	Quiche	800	20-22	180
	Muffins	800	15-18	200
	Sweet snacks	800	20	160

TROUBLESHOOTING

Problem	Possible cause	Solution
The air fryer oven does not work	The appliance is not plugged in.	Connect the supply cord plug into an earthed power outlet socket. Check the power outlet socket is switched ON.
Food not well cooked.	The amount of ingredients is too large.	Put smaller batches of ingredients in the air fryer oven. Smaller batches are fried more evenly.
	The set temperature is too low.	Set a higher temperature.
	The set time is too short.	Set a longer time.
Fried snacks are not crispy	You used a type of snacks meant to be prepared in a traditional deep fryer.	Use oven snacks or lightly brush some oil onto the snacks for a crispier result. Do this before starting the cooking process.
	The pan still contains grease residues from previous use.	Make sure you clean the appliance and accessories properly after each use.
Fresh fries are fried unevenly	You did not use the right potato type.	Use fresh potatoes to ensure sure they stay firm during frying.
	You did not rinse the potato sticks properly before frying.	Rinse the potato sticks properly to remove starch from the surface.
Fresh fries are not crispy	The crispiness of the fries depends on the amount of oil and water in the fries.	Make sure you dry the potato sticks properly before you add mist of oil. Cut the potato sticks smaller for a crispier result.
White smoke coming from Unit	Oil is being used. Accessories have excess grease residue from previous cooking.	Wipe down to remove excess oil. Clean the appliance and accessories after each use.
Food is not fried evenly	Some foods need to be turned during the cooking process.	Refer to tips when cooking with your air fryer oven.

CLEANING AND STORAGE

- Clean the air fryer oven after each use.
- Remove the power cord from the power outlet socket and ensure the appliance is thoroughly cooled before cleaning.
- Clean the door, inside and outside of the appliance with a warm, moist cloth or a nonabrasive sponge with mild detergent.
- Take off the door for cleaning if necessary. Do not soak or submerge the door in water or wash in the dishwasher.
- The accessories are dishwasher safe. Never use abrasive cleaning materials.
- Make sure all components are clean and dried thoroughly before storing
- Store the appliance in a clean and dry location.

TECHNICAL SPECIFICATION

Voltage: 220-240V~ 50-60Hz

Power: 1800W

12 Month Warranty

Thank you for your purchase from Kmart.

Kmart Australia Ltd warrants your new product to be free from defects in materials and workmanship for the period stated above, from the date of purchase, provided that the product is used in accordance with accompanying recommendations or instructions where provided. This warranty is in addition to your rights under the Australian Consumer Law.

Kmart will provide you with your choice of a refund, repair or exchange (where possible) for this product if it becomes defective within the warranty period. Kmart will bear the reasonable expense of claiming the warranty. This warranty will no longer apply where the defect is a result of alteration, accident, misuse, abuse or neglect.

Please retain your receipt as proof of purchase and contact our Customer Service Centre on 1800 124 125 (Australia) or 0800 945 995 (New Zealand) or alternatively, via Customer Help at Kmart.com.au for any difficulties with your product. Warranty claims and claims for expense incurred in returning this product can be addressed to our Customer Service Centre at 690 Springvale Rd, Mulgrave Vic 3170.

Our goods come with guarantees that cannot be excluded under the Australian Consumer Law. You are entitled to a replacement or refund for a major failure and compensation for any other reasonably foreseeable loss or damage. You are also entitled to have the goods repaired or replaced if the goods fail to be of acceptable quality and the failure does not amount to a major failure.

For New Zealand customers, this warranty is in addition to statutory rights observed under New Zealand legislation.