

Assembly Instructions









43031726 Rattan Look Shelving Unit

WARNING: DO NOT STAND, SIT OR LEAN ON THE UNIT. DO NOT USE THIS UNIT AS A STEP LADDER. ENSURE THIS UNIT IS USED ONLY ON A FLAT SURFACE. DO NOT USE THIS UNIT UNLESS ALL BOLTS AND SCREWS ARE FIRMLY SECURED. DO NOT PLACE HOT OBJECTS SUCH AS COFFEE CUPS DIRECTLY ON THE SURFACE OF THIS FURNITURE ITEM. THIS ITEM IS FOR STORAGE PURPOSE ONLY. CONTAINS SMALL PARTS. IT IS TO BE ASSEMBLED BY AN ADULT. FAILURE TO FOLLOW THESE WARNINGS COULD RESULT IN SERIOUS INJURY.

CARE INSTRUCTION: WIPE CLEAN WITH A SOFT DAMP CLOTH. NEVER USE SCOURERS, ABRASIVES OR CHEMICAL SOLVENTS. KEEP AWAY FROM MOISTURE AND DIRECT SUNLIGHT. STORE IN A DRY PLACE FOR INDOOR USE ONLY.

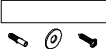
MAXIMUM LOAD FOR EACH SHELF: 7KG.

Hardware list

	A		1PC		E	M5X25	4PCS
	B		1PC		F	M5X40	12PCS
	C		1PC		G	M4X20	2PCS
	D		3PCS		H		2PCS
	AA/BB		1PC				

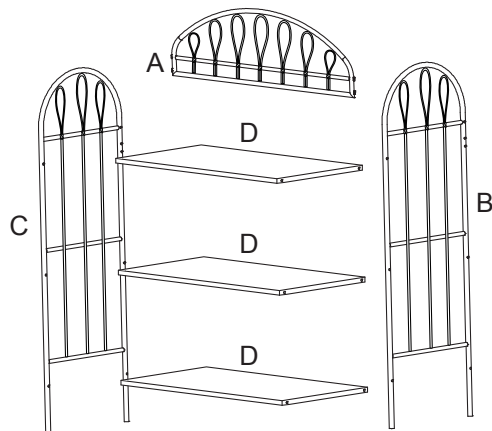

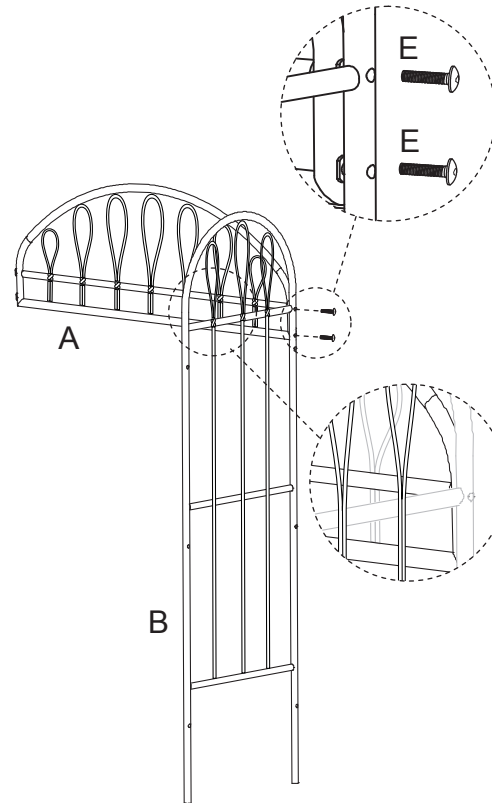

ATTENTION: DO NOT TIGHTEN THE SCREWS FULLY DURING ASSEMBLY. FULLY TIGHTEN SCREWS AFTER THE FINAL ASSEMBLY STEP.

STEP 1 E x 2

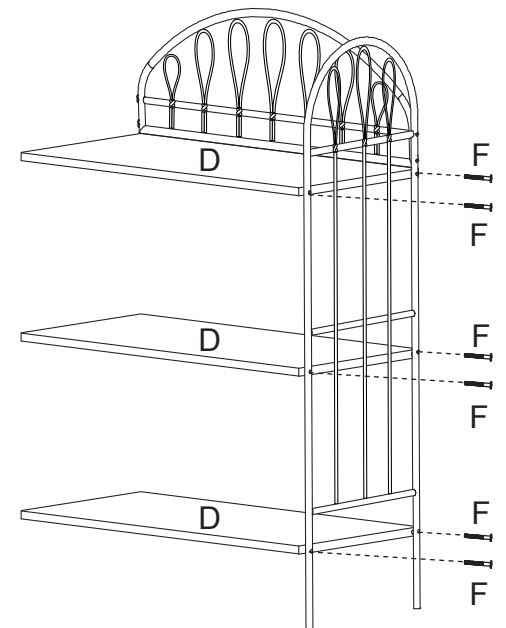

STEP 2 F x 6



STEP 3  E x 2  F x 6

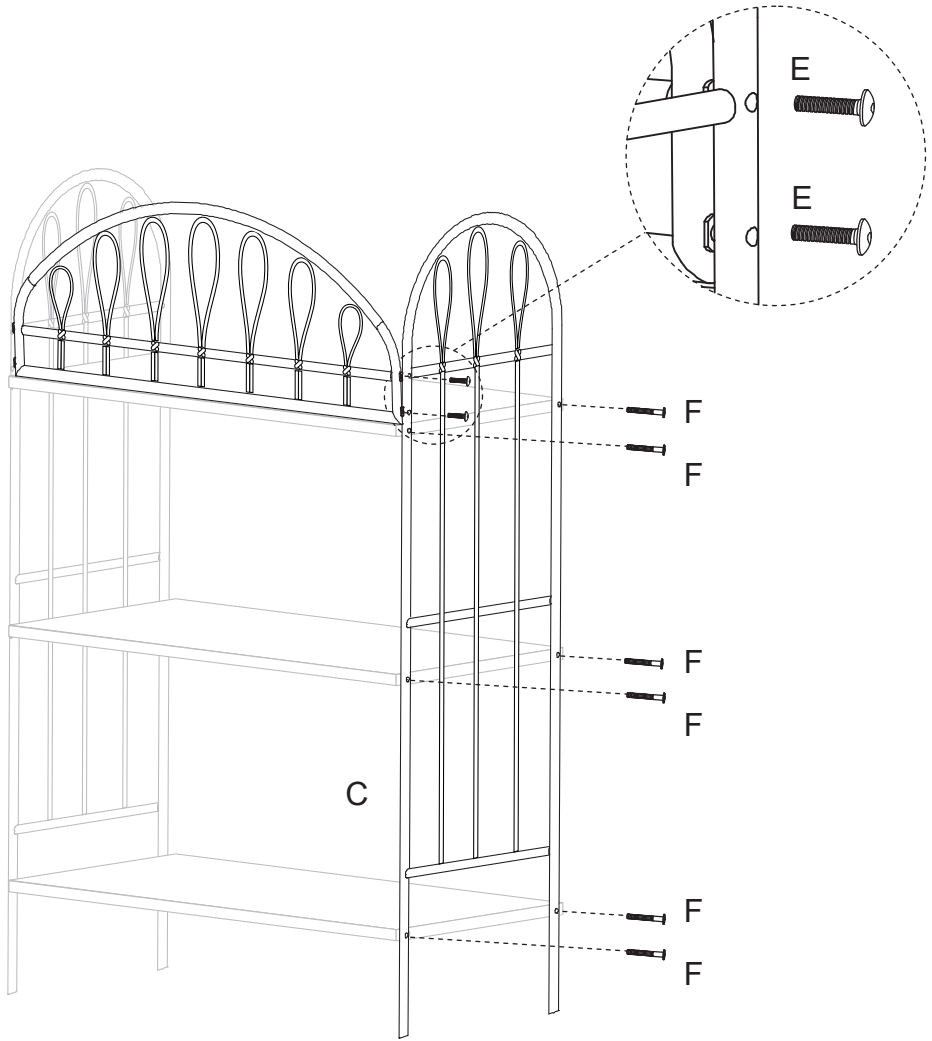

STEP 4  G x 2

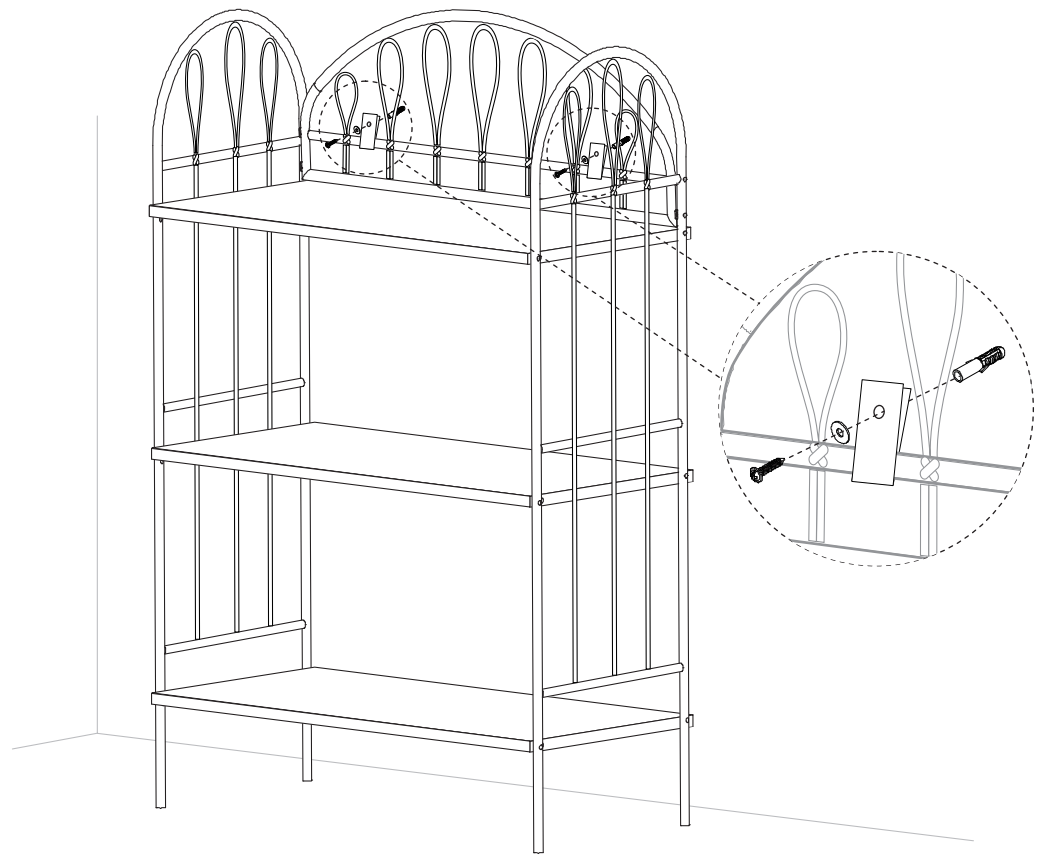

USER INSTRUCTION FOR WALL ANCHOR:
 IT IS STRONGLY RECOMMENDED THAT THIS PRODUCT IS PERMANENTLY FIXED TO THE WALL. PLEASE SEEK PROFESSIONAL ADVICE IF YOU ARE IN DOUBT OF WHAT FIXING DEVICE TO USE. REGULARLY CHECK THAT ANCHORS ARE SECURELY MAINTAINED. CAUTION: FOR YOUR SAFETY WHEN ATTACHING THE ANCHOR FIXINGS, PLEASE NOTE THE FOLLOWING: CHECK ANY ELECTRICAL WIRES OR PLUMBING INSIDE THE WALL BEFORE DRILLING ANY HOLES (IF YOU ARE UNSURE PLEASE SEEK PROFESSIONAL ADVICE FROM A QUALIFIED TRADESPERSON)

 TOPPLING HAZARD	<p>WARNING: PLEASE SECURE YOUR FURNITURE WITH THE SUPPLIED WALL FIXING. SCAN THE CODE FOR MORE INFORMATION.</p>	
--	--	---